



PUMA 3303 Multi Carrier

User manual

EN

1. edition

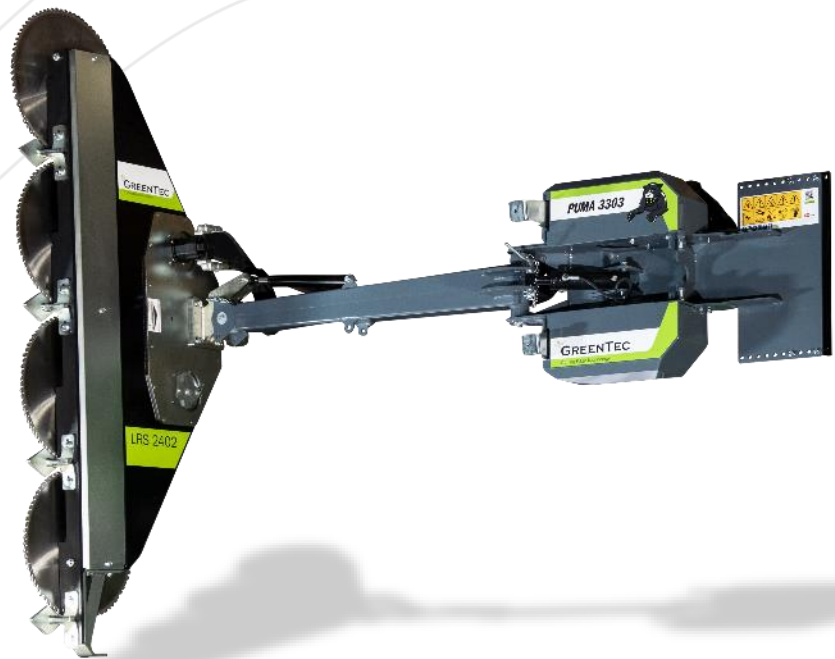

The original content of this user manual cannot be re-produced, distributed, transmitted, transcribed, or translated without the prior written permission from GreenTec.

Copyright © 2024 GreenTec A/S
All rights reserved.

 **Made in Denmark**
Designed and manufactured



**GREENTEC**
Cutting Edge Technology

Merkurvej 25, DK-6000 Kolding
+45 75 55 36 44 | info@GreenTec.eu | www.GreenTec.eu

PUMA 3303 Multi Carrier

User manual

1. edition – February 2024
(Original version)

! IMPORTANT !

For correct operation, this **GreenTec PUMA 3303 Multi Carrier** must be mounted on an approved vehicle with an approved attachment tool.

It is important that the operator is given both the user manual, spare parts book, and all other relevant technical documentation for both the Multi Carrier, attachment tool and vehicle before the machine is put into use for the first time.

It is important that the operator fully understands the contents of the instruction material before using the machine.

This user manual must accompany the machine and must always be available to the operator.

In case of later resale of the machine, all relevant technical documentation must be handed over to the new owner.

The content of the user manual is based on information, standards, and regulations, valid at the time of publication.

As our products are under continuous development and improvement, changes to the specifications may occur.

If there is information that differs from the current machine, updated instructions can be found on our [webpage](#) or by contacting [GreenTec After-sales service](#) department at: service@greentec.eu

Manufacturer, name, and address (a)



Merkurvej 25
DK-6000 Kolding
Danmark

Tel: +45 75553644
Fax: +45 75554243
E-mail: info@greentec.eu
Web: www.greentec.eu

Preface

Dear Customer!

Your new GreenTec machine is designed based on almost 30 years of experience with vehicle-mounted machines for maintaining green areas.

The machine is manufactured based on the latest technology and approved safety regulations, standards, and regulations.

We want to make a product available in a way that does not cause damage or misunderstandings either during use, during transport or during maintenance of the machine.

The user manual contains information and instructions that are important and useful for maintaining the operational safety, reliability, and value of the GreenTec machine.

Therefore, read this user manual carefully, as it will make you familiar with assembly, use, care, and maintenance. **Pay particular attention to instructions regarding safety!**

You are welcome to visit our website www.greentec.eu - where you can find technical documentation and access the latest updates to instruction- and spare parts books on our entire product range.

We hope that you will be satisfied with your new GreenTec machine!



Kind regards:



John Christensen

Co-owner, Product Development
GreenTec A/S

GreenTec's vision is to develop and sell quality machines for the maintenance of green areas, i.e., in agriculture, industry, airports and the municipal sector. Through innovative product development, we strive to become a leader in our field.

All machines are developed in a simple, functional, and production-friendly design in close cooperation with dealers and end users. It is our goal to cover all needs in the market segment with a minimum of 2 different proposed solutions.

Through in-depth analysis and counselling, the customer must be offered the best possible solution, where individual needs can also be met through the modular structure of the product range.

The aim is also to offer the best possible after-sales service and a fast and efficient supply of spare parts.

Contents

(Letters in headings (x) refer to Machinery Regulation (EU) 2023/1230, Paragraph 1.7.4.2, "Contents of the instructions" sections a – u)

Manufacturer, name, and address (a)	A
Tables and figures.....	F
Tables in this user manual.....	F
Figures in this user manual.....	G
Declaration of conformity (c).....	1
1) Machine data and useful info (b).....	2
1.1) Registration of Greentec machine data	2
1.2) Name plate	3
1.3) Warranty terms.....	3
1.4) Complaints	4
1.5) Use with other manufactures than Greentec	4
2) General information.....	5
2.1) Use of the user manual	5
2.2) Definitions of information signs	5
2.3) Definitions, terms, and descriptions	5
3) Safety.....	6
3.1) Local legislation in the country where the machine is used.....	6
3.2) Warnings, prohibitions, and instructions	6
3.3) Safety labeling.....	6
3.3.1) Personal safety equipment.....	6
3.3.2) Warning labels.....	7
3.4) Working in publicly accessible places.....	8
3.4.1) Warnings signs in public places.....	8
3.4.2) Use of warnings signs	8
3.4.3) Suggested signage when working on public roads	9
3.5) Recommendations for optimal security and operation (l)	10
3.5.1) Safety distances	11
3.5.1.1) Overhead power lines.....	12
3.6) Necessary safety measures (m)	13
3.7) Warnings on how the machine must not be used (h).....	14
3.8) Safety instructions for maintenance, adjustment, and inspection (s)	15
3.9) Safety instructions for the operator / user	15
4) Machine description (d).....	16
4.1) Overview and features.....	16
4.2) Use of the machine	18
4.2.1) Intended use of the machine (g).....	18
4.2.2) Application and restrictions of the machine (h)	18
4.3) Components of the machine	19
4.3.1) Steel main frame w. swing arm.....	19

4.3.1.1)	Support feet.....	19
4.3.2)	Hydraulic cutting angle adjustment	20
4.3.3)	Automatic hydraulic impact protection (AHS).....	21
4.3.3.1)	Function of the automatic hydraulic impact protection (AHS)	22
4.3.4)	Oil flow divider with overpressure- and anti-cavitation valve	23
4.3.4.1)	PUMA 3303 Standard (without e-control).....	23
4.3.4.2)	PUMA 3303 Plus (with e-control).....	24
4.3.5)	1,5 m (4'11") hose-kit.....	25
4.3.6)	Loader brackets for mounting on vehicles.....	26
4.4)	Approved attachment tools and optional equipment (n).....	28
4.5)	Optional equipment.....	29
4.5.1)	Counterweights (110 kg. / 243 lbs.).....	29
4.5.2)	8.5 m (27'11") hose kit (from front loader to tractor rear) - 3 pcs. or 5 pcs.	30
4.6)	Specifications.....	31
4.7)	Noise measurement of airborne noise (u)	32
5)	Instructions for using the machine (k).....	33
5.1)	GreenTec.eu – Explore and learn!.....	33
5.2)	GreenTec.eu – FAQ.....	33
5.3)	Instructions regarding delivery of the machine	34
5.3.1)	Transport damage	34
5.4)	Instructions for mounting, connecting, and disconnecting (j)	35
5.4.1)	Preparation of vehicle and operator.....	35
5.4.2)	Preparation of PUMA 3303 Multi Carrier (Initial start-up).....	36
5.4.3)	Mounting and connecting the machine (i)	37
5.4.3.1)	Mounting and connecting the PUMA 3303 Multi Carrier to the vehicle.....	38
5.4.3.2)	Un-mounting and disconnecting the PUMA 3303 Multi Carrier from the vehicle:.....	42
5.4.3.3)	Mounting and connecting attachment tools to the PUMA 3303 Multi Carrier	42
5.5)	Preparing the machine for use	43
5.5.1)	Procedures before start-up and use.....	43
5.5.2)	Training of machine operators before use	43
5.5.3)	Stability (o).....	44
5.5.3.1)	Checking the stability:	44
5.5.3.2)	Stability can be increased by:	45
5.5.3.3)	Factors influencing stability:.....	45
5.5.4)	Initial start-up and commissioning.....	46
5.6)	Operation of the machine (e).....	48
5.6.1)	Operator's workplace (f)	48
5.6.2)	Transport of Multi Carrier and attachment tool on a vehicle (p).....	49
5.6.3)	Start of attachment tool.....	50
5.6.4)	Stop of attachment tool	53
5.6.5)	Setting and adjusting the machine (r).....	54
5.6.5.1)	Setting the Multi Carrier on a vehicle.....	54

5.6.5.2)	Setting the working position of the swing arm.....	55
5.6.5.3)	Adjusting the cutting angle for the attachment tool.....	56
5.6.5.4)	Function of PUMA e-control	57
5.6.6)	Driving instructions.....	58
5.6.7)	Start-up after unintended / accidental stoppage (q).....	61
6)	Inspection and maintenance (e, r)	62
6.1)	Instructions for safe maintenance and adjustment (s).....	63
6.1.1)	Properly move your GreenTec machine	63
6.2)	Daily and routine inspections (e).....	64
6.3)	Tightening of bolts and hydraulic connections	66
6.3.1)	Tightening of bolts.....	66
6.3.2)	Tightening of hydraulic hoses- and fittings	67
6.4)	Hydraulic hoses.....	68
6.5)	Bearings, shafts, pins, and bushings.....	69
6.6)	Checking pressure- and flow specifications.....	70
6.6.1)	Correct measurement of pressure and flow	70
6.6.2)	Re-filling the accumulator.....	71
6.7)	Cleaning/washing the machine	72
6.8)	Lubrication of the machine.....	73
6.3.	73
6.8.2)	Worn / blank metal parts.....	74
6.9)	Storage of the machine	75
6.10)	Disposal of machine/machine parts	75
7)	Troubleshooting the machine	76
7.1)	Troubleshooting procedures	76
8)	Appendix	78
8.1)	Hydraulic diagrams	78
8.2)	Electrical diagrams	79

Tables and figures

Tables in this user manual

Table 1 – Machines covered by declaration of conformity.....	1
Table 2 – Declared international standards	1
Table 3 – Machine data form	2
Table 4 – Content of GreenTec name plate.....	3
Table 5 – Warranty coverage	3
Table 6 – Definitions, terms and descriptions.....	5
Table 7 – Overview of equipment.....	17
Table 8 – Data sheet: Automatic hydraulic impact protection (AHS).....	21
Table 9 – Data sheet: Oil flow divider (PUMA 3303 Standard).....	23
Table 10 – Data sheet: Oil flow divider w. e-control (PUMA 3303 Plus).....	24
Table 11 – Data sheet: 1.5 m (4'11") hose-kit	25
Table 12 – Loader brackets for PUMA 3303 Multi Carrier	26
Table 13 – Approved attachment tools and optional equipment	28
Table 14 – Data sheet: Counterweights (110 kg. / 243 lbs.).....	29
Table 15 – Data sheet: 8.5 m (27'11" ft) hose kit.....	30
Table 16 – Data sheet: Machine specifications.....	31
Table 17 – Measurement of A-weighted sound power level.....	32
Table 18 – Checklist for delivery of machine	34
Table 19 – Preparation of PUMA 3303 Multi Carrier.....	37
Table 20 – Mounting and connecting the PUMA 3303 Multi Carrier onto a vehicle (1/4)	38
Table 21 – Mounting and connecting the PUMA 3303 Multi Carrier onto a vehicle (2/4)	39
Table 22 – Mounting and connecting the PUMA 3303 Multi Carrier onto a vehicle (3/4)	40
Table 23 – Mounting and connecting the PUMA 3303 Multi Carrier onto a vehicle (4/4)	41
Table 24 – Procedures for initial start-up and commissioning.....	46
Table 25 – Setting the Multi Carrier on a vehicle.....	54
Table 26 – Setting the working position of the swing arm.....	55
Table 27 – Adjusting the cutting angle for the attachment tool.....	56
Table 28 – Driving instructions: PUMA 3303 Multi Carrier (1/2).....	59
Table 29 – Driving instructions: PUMA 3303 Multi Carrier (2/2)	60
Table 30 – Checklist for daily inspections: Before and after commissioning.....	64
Table 31 – Checklist for semi-annual inspection: preventive maintenance.....	65
Table 32 – Tightening torques for bolts	66

Table 33 – Tightening torques for hydraulic hoses and fittings.....	67
Table 34 – Measurement of pressure and flow: PUMA 3303 Multi Carrier	70
Table 35 – Overview of the disposal/scrapping of machine parts.....	75
Table 36 – Identifying error / faulty conditions	77

Figures in this user manual

Figure 1 – Name plate for GreenTec machine.....	3
Figure 2 – Safety labelling: personal safety equipment	6
Figure 3 – Safety labeling: warning labels.....	7
Figure 4 – Proposed signage for work on public roads	9
Figure 5 – Safety zones (Vehicle/attachment tool).....	11
Figure 6 – Safety zones (Overhead power lines)	12

Declaration of conformity (c)

Acc. to Machinery Regulation (EU) 2023/1230 Annex V.A

MANUFACTURER: GreenTec A/S
ADDRESS: Merkurvej 25
LOCATION: DK-6000 Kolding



We, GreenTec A/S, hereby declare that the machine:

TYPE:	PRODUCT:	APPROVED WITH:
Multi Carrier	PUMA 3303 9993303L-50S, 9993303R-50S, 9993303L-50P, 9993303R-50P	LRS 2002 Quadsaw LRS 2402 Quadsaw RC 162 Rotary Hedge Cutter HX 170 Cutterbar HX 230 Cutterbar HX 270 Cutterbar HS 212 Cutterbar HS 242 Cutterbar

Table 1 – Machines covered by declaration of conformity

- is manufactured in conformity with both the European Parliament and Council Regulation (EU) 2023/1230, and UK Statutory Instrument 2008 No. 1597: The Supply of Machinery (Safety) Regulations 2008, with references to the following standards associated with its design, construction, and production:

NAME:	DESCRIPTION:
BS/EN ISO 12100:2011	Safety of machinery – General principles for design – Risk assessment and risk reduction
BS/EN ISO 14120:2015	Safety of machinery – Guards – General requirements for the design and construction of fixed and movable guards
BS/EN ISO 4413:2010	Hydraulic fluid power – General rules and safety requirements for systems and their components

Table 2 – Declared international standards

The declaration only applies if the machines stated above are used in accordance with the operating instructions.

When connecting the above-mentioned machines to a vehicle and/or with attachment tools other than those mentioned above, it is the responsibility of the owner and operator to ensure that the vehicle and the assembled machines meet the applicable requirements in the relevant directives for this.

Date: 01.02.2024

A handwritten signature in black ink, appearing to read 'John Christensen', is written over a light blue horizontal line.

John Christensen

Co-owner, Product Development
GreenTec A/S

1) Machine data and useful info (b)

Before the machine is put into use for the first time, the dealer is responsible for ensuring that the buyer receives this document and that the machine is correctly registered via the Extranet on GreenTec's website:

<https://extranet.greentec.eu/login>

If in doubt regarding login information, please contact GreenTec After-sales service: service@greentec.eu

The dealer/importer must also ensure that the buyer and operator fully understand the contents before the machine is put into use.

If the machine is re-sold, all the supplied technical documentation must be handed over to the new owner and must also always accompany the machine.

The fields below are filled in, for future use when ordering spare parts or other enquiries:

1.1) Registration of Greentec machine data

DATA TO BE ENTERED BY THE DEALER VIA THE GREENTEC EXTRANET!

Machine description:

Serial number:

Sales date:

Dealer:

E-mail:

Phone:

Table 3 – Machine data form



1.2) Name plate

All GreenTec's machines are equipped with a name plate.

The nameplate contains important information relating to the machine, including a unique serial number used for identification.

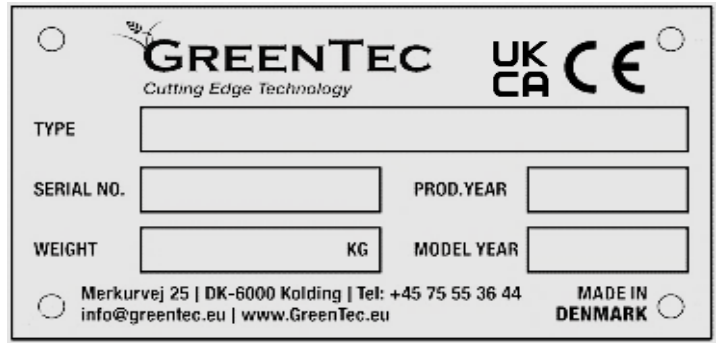

Figure 1 – Name plate for GreenTec machine

CONTENT OF THE NAME PLATE:	
TYPE:	Machine model and type number.
SERIAL NO.:	Unique serial number of the machine.
PROD. YEAR:	Production year.
WEIGHT:	Weight of the machine <i>without</i> optional equipment (kg.)
MODEL YEAR:	The year of development of the machine model.

The nameplate also provides address information for the manufacturer.

Table 4 – Content of GreenTec name plate

1.3) Warranty terms

- GreenTec must be notified in writing of errors or defects in the sold machine **no later than 8 days** after the error was or should have been registered by the end-user. If not notified within this period, the customer is not entitled to submit claims regarding errors or defects.
- GreenTec is entitled and obliged to remedy all errors and defects within the specified coverage of the product warranty, being able to decide freely whether such remediation must take place in the form of repair or replacement of the defective part(s).
- Warranted parts, can be re-called upon by GreenTec for inspection, if needed. Unless otherwise agreed, warranted parts must be available for return, free of charge, to GreenTec's After-sales service department - **no later than 14 days** after replacement.
- When warranty work is carried out, **always** make sure to have the original invoices for any spare parts used, and timesheets for the labour and working hours available as documentation.

THE WARRANTY COVERS:	THE WARRANTY DOES NOT COVER:
✓ Defective or faulty design and/or materials.	✗ Normal wear and tear.
✓ Improper or faulty workmanship.	✗ Insufficient service and maintenance.
✓ Original GreenTec parts and materials.	✗ Improper use and/or handling of the machine.
<i>GreenTec's warranty obligation is conditioned to the customer documenting that an identified deficiency or fault is not due to any of the above circumstances.</i>	✗ Overloading of the machine and equipment.
<i>GreenTec assumes no liability for any of the mentioned points, including loss of profits, lost earnings, and other consequential financial loss. Please read through GreenTec's overall terms and conditions of sale and delivery here: https://greentec.eu/about-us/terms-and-conditions-of-sale-and-delivery/</i>	✗ Incorrect installation and/or mounting.
	✗ Use of non-original spare parts and materials.
	✗ Any 3rd party modifications made to the machine.
	✗ Hydraulic- and/or gear oil, lubricants, or any other propellants.
	✗ Compensation for transport or any consequential costs.
	✗ Any damage and defects due to violation of road and/or traffic regulations.

(Labour costs associated with a warranty are always settled at a fixed standard rate, agreed between GreenTec and our dealers)

Table 5 – Warranty coverage

1.4) Complaints

Risk for the goods is transferred to the customer immediately upon delivery. Complaints about goods must be made in writing and submitted to GreenTec without undue delay and **no later than 8 days after delivery**. If GreenTec has not received a complaint within the mentioned time limit, the customers lose all rights to complain about the quantity and quality of the goods delivered.

GreenTec has the right and obligation to remedy all errors resulting from defective design, materials, and workmanship. GreenTec decides whether the remedy must be in the form of repair or replacement of the defective part(s).

If GreenTec chooses to repair the goods, the customer is obliged to deliver and collect the goods from a workshop indicated by GreenTec, without GreenTec incurring costs in this context.

If GreenTec chooses to replace the defective part(s), customers must send the defective part(s) to GreenTec without GreenTec incurring costs in this regard. Instead, GreenTec is entitled to supply replacement goods.

GreenTec's liability only applies to defects, in connection with the sold goods, which are indicated within 2 years from the delivery date.

GreenTec assumes no responsibility for defects that exceed what is stipulated in this provision. This applies to losses resulting from such a deficiency, including loss of profit, lost earnings, and other financial loss.

1.5) Use with other manufactures than Greentec

NOTICE

When installing other makes of attachment tools than GreenTec, a new risk assessment of the equipment used must be submitted.

If the Multi Carrier is fitted with an unapproved attachment tool, the basis for risk assessment will no longer apply, and thereby the validity and guarantee of the declaration of conformity.

It is every operator's own responsibility to risk assess this interconnection before using the machine.

2) General information

2.1) Use of the user manual

Read this user manual thoroughly before assembling and putting the machine into use. If you have any questions, contact your local dealer or GreenTec's after-sales service department.

NOTICE

The illustrations in this user manual have the sole purpose of instructing, informing, and substantiating the general procedures and instructions. Illustrations may appear different from the actual machine, e.g., by being fitted with additional equipment and/or in a different size variant.

2.2) Definitions of information signs

The following definitions apply throughout this user manual:

⚠ DANGER

DANGER!

Warns of a potential situation that could result in death or permanent disabling injury if instructions are not followed carefully!

⚠ WARNING

WARNING!

Warns of a potential situation that could result in partially disabling injuries or serious bodily injury if the instructions are not followed carefully!

⚠ CAUTION

CAUTION!

Warns of a potential situation that could result in serious damage to the machine or equipment if the instructions are not followed carefully!

NOTICE

NOTICE!

Specific or general information deemed important or useful.

2.3) Definitions, terms, and descriptions

Operator:	Daily user and/or operator of the machine.
Owner:	Owner, buyer and/or those who are responsible for the operator and maintenance.
Multi Carrier:	Multi Carrier, support arm / lift arm which controls, handles, and carries attachment tools during operation.
Attachment tool:	Attachment tool that is handled and carried by Multi Carrier during operation.
Vehicle:	Machine that transports Multi Carrier + attachment tool during operation.
RH / LH	RH: Right-sided unit / LH: Left-sided unit.

Table 6 – Definitions, terms and descriptions

3) Safety

3.1) Local legislation in the country where the machine is used

The use of the machine may be restricted by the legislation of the countries where it is used. It is important that the responsible owner and operator familiarize themselves with the country's laws and regulations regarding cutting, pruning and maintenance of fences and hedges.

3.2) Warnings, prohibitions, and instructions

Instructions come from the applicable national accident prevention regulations, which the operator and operator must comply with:

WARNING

For all types of work on the machine, it must be disconnected from all hydraulics!

WARNING

Only authorized personnel may carry out service and maintenance on the machine!

CAUTION

Read the user manual carefully before using the machine!

3.3) Safety labeling

The machine is marked with safety and warning labels, these are placed at the identified dangers to which you are exposed when working with and staying near the machine.

3.3.1) Personal safety equipment

It is recommended that the following safety equipment is worn when working with or performing maintenance on the machine:



Working suit



Safety shoes



Safety glasses



Hearing protection



Safety helmet



Protective gloves

Figure 2 – Safety labelling: personal safety equipment

The recommended safety equipment together with the points of attention mentioned in this and the following section cover the precautions GreenTec has deemed necessary for use. The varying circumstances that may arise when working with this machine cannot always be predicted.

No good advice can replace "common sense", "due care" and "attention", but the above recommendations are a good start to safe use of the GreenTec machine.

3.3.2) Warning labels

Warning labels that identify the dangers to which you are exposed when working with and when staying near the machine:

WARNING LABELS:



	<p>Warning!</p> <p>Read relevant user manuals carefully before using this machine.</p> <p>Follow all instructions and safety regulations when using the machine.</p>		<p>Warning!</p> <p>Check every 8 hours of use that all bolts/nuts are tight.</p>
	<p>Warning!</p> <p>Beware of oil in case of skin contact or inhalation of oil vapors, as well as high pressure in case of leakage or handling.</p> <p>Switch off the engine, remove the key and apply the parking brake before maintenance or repair work.</p>		<p>Warning!</p> <p>Take care of the swing arm of the machine during use.</p> <p>Keep your distance and always stay out of reach of the machinery.</p>
	<p>Warning!</p> <p>Closed hydraulic circuit under high pressure. Stated value: 50 bar.</p> <p>The impact protection cylinder is under constant pressure from the accumulator.</p> <p>Any separation without draining the pressure will result in violent splashes, oil vapors and oil mist which can be very dangerous by inhalation and skin contact. Only to be disassembled by a skilled mechanic after the pressure has been drained by the system.</p>		<p>Warning!</p> <p>Always pay attention to overhead lines! Between the electricity masts, there will always be a risk of touching the overhead lines.</p> <p>If in doubt - contact the local electrical works for instructions on safety distance.</p>

Figure 3 – Safety labeling: warning labels

3.4) Working in publicly accessible places

When working in publicly accessible places, such as roadsides, consideration must be given to the presence of others in the area.

Immediately stop the machinery when, for example, pedestrians, cyclists, horse riders etc. approach the safety zone. Only resume work when they are at a safe distance again.

When the machine is used on public roads, applicable traffic laws must be observed in every event.

3.4.1) Warnings signs in public places

- The work area should be marked with appropriate signage, this is a legal requirement in public places.
- Signage must be clear and correctly placed so that the danger is made clear.
- Contact the local road authority for detailed information on applicable legislation.
- The local road authority should be notified before work begins on a public road.

3.4.2) Use of warnings signs

- On two-way roads, signage must occur in both directions.
- The work should be within 1 km of signage.
- Only carry out work when visibility is good and when the risk is the least – e.g., outside rush hour.
- The vehicle must be equipped with flashing orange light beams.
- Vehicles should be in a conspicuous colour and the operator should be wearing visible clothing.
- Remaining material should be removed from the road and pavement as soon as practicable and at suitable intervals.
- The work must be carried out before warning signs are removed.
- Collect all road signs as soon as the work is completed.

3.4.3) Suggested signage when working on public roads





	Mandatory sign:
	"Keep left" White and blue arrow signage. Visibly marked on the back of the machine.
	Warning sign:
	"Road work" Supplementary text for work carried out at a suitable distance. Example: "Verge cutting 0-1 km"
	Warning sign:
	"Road narrowing" Adding text: "One lane only"

Figure 4 – Proposed signage for work on public roads

NOTICE

The above signage applies within i.e., EU mainland, where traffic passes on the left of the machine working in the direction of travel.

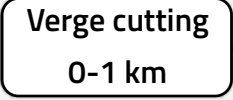
Signage, use of and colours on arrow signs as well as indications depend on the language, laws, and regulations of the individual country.

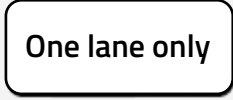
3.5) Recommendations for optimal security and operation (I)

⚠ DANGER

Always be aware of the following risks when using the machine:

To achieve optimal safety and operation, it is important that the operator understands how dangerous the machine is, and foresees the danger before it occurs:

- ⚠ You may get stuck when the machinery is engaged or disengaged and when the lift arm system or Multi Carrier is moved out or in, up or down and forwards or backwards.
- ⚠ The machinery can tip over when the lift arm system or Multi Carrier is raised.
- ⚠ You can be caught by the rotating shaft from the PTO.
- ⚠ You can be hit or caught by the moving parts, e.g., flails, blades, knives, drive shaft and wings from mounted attachment tools, or hit by flying materials or machine parts in case of machine damage.
- ⚠ The attachment tools are powered by hydraulic oil from the hydraulic system in the machine or from the vehicle.
- ⚠ The operator of the vehicle should know how the hydraulic oil should be handled! (Read in the safety data sheet for the oil)
- ⚠ Oil splashes under high pressure from damaged fittings or hydraulic hoses can penetrate the skin and cause serious injury.
- ⚠ Accidents due to collisions with other vehicles or dropped objects on the road.

3.5.1) Safety distances

When using the machinery, there is a risk that the attachment tool may throw flying objects-/material. Depending on the driving conditions and surface, there will be the possibility that serious fragments can come flying and damage people or equipment.

- **Always comply with the specified safety distances (SDF/SDR) to the machinery.**

When using the machinery there is a risk of being hit or caught by the moving parts, e.g. flails, blades, knives, drive shaft and wings from mounted attachment tools, as well as being hit by flying materials or machine parts in the event of machine damage.

- **Always comply with the specified safety radius (SR) for the machinery.**



During commissioning, persons must **under no circumstances** enter the safety zones marked on the drawings!

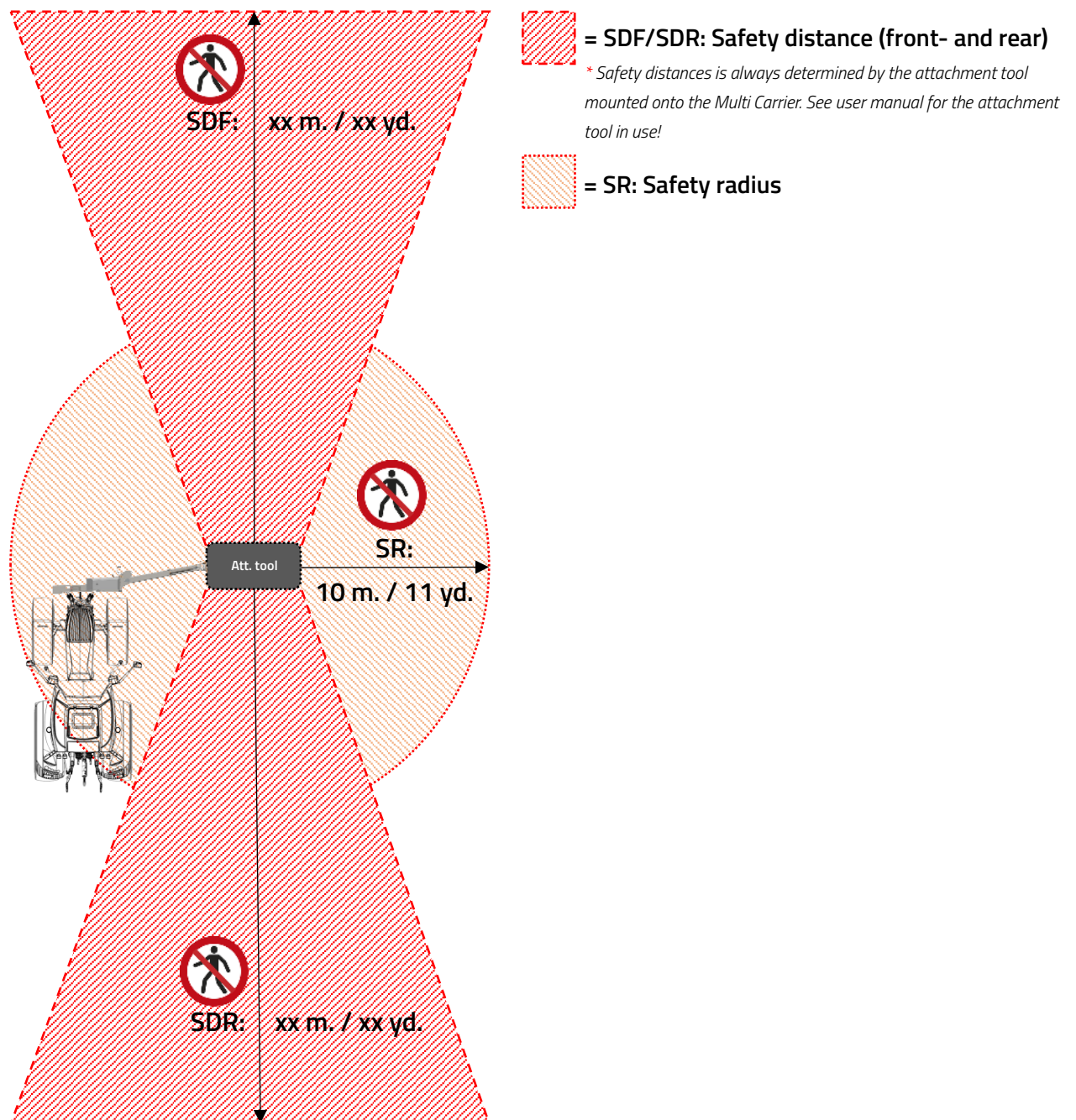

Figure 5 – Safety zones (Vehicle/attachment tool)

3.5.1.1) Overhead power lines

Always pay attention to overhead power lines and work at a safe distance from them! Between electricity masts, there will always be a risk of touching the overhead lines. A safe working distance depends on the voltage of the power lines. **Always observe the specified minimum safety distance!**

The higher the voltage, the greater the distance required between the power lines and the machinery! When in doubt – always contact the local power company for safety instructions!



NOTICE

The safety instructions comply with the instructions of applicable international organizations and legal requirements in various decrees on safety for carrying out work in the vicinity of electrical installations → Sikkerhedsstyrelsen (DK), HSE (UK), BAuA (DE) and OSHA (US).

DANGER

During commissioning, persons, machinery, tools and other materials must **under no circumstances** come within the grey area marked on the drawings!

CAUTION

The safety distances do not apply to agricultural machinery if the total machinery incl. its driver does not exceed a height of 4 m./13 ft. in the case of low-voltage electrical installations and 4.5 m./14.75 ft. in the case of high-voltage electrical installations.

If the agricultural machinery is higher than this, the following safety distances must always be observed!

Low voltage overhead lines* (0 – 0,4 kV)

Horizontal distance: **1,5 m. / 5 ft.**
Vertical distance: **3 m. / 10 ft.**

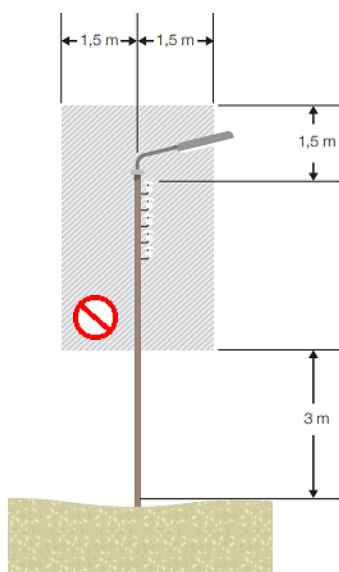

* In the case of low-voltage overhead lines, work can be done above the masts by observing a safety distance of 1.5 m. / 5 ft.

High voltage overhead lines (10 – 40 kV)

Horizontal distance: **6 m. / 20 ft.**
Vertical distance: **3 m. / 10 ft.**

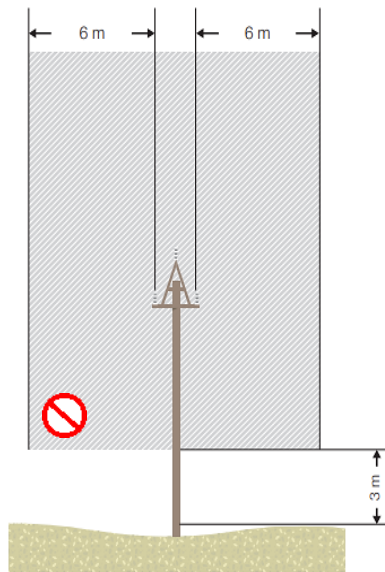

High voltage overhead lines* (40 – 400 kV)

Horizontal distance: **15 m. / 50 ft.**
Vertical distance: **3 m. / 10 ft.**

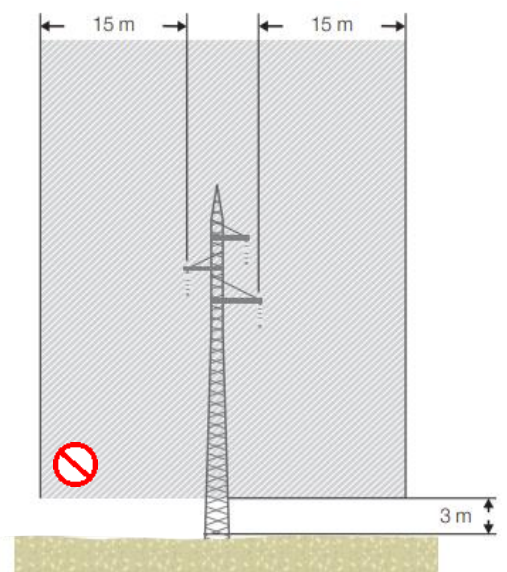

* At a higher voltage than +400 kV: Safety distance must be determined by the network owner/operating manager or registered professional engineer.

Figure 6 – Safety zones (Overhead power lines)

3.6) Necessary safety measures (m)

NOTICE

The machine must be used in the following ways:

- ✓ Make sure that the operator of the machine has read this user manual, as well as the user manuals for both the attachment tool and the vehicle used.
- ✓ Ensure that the operator of the machine has been trained in the use of the machine.
- ✓ Use hearing protection if the machine is operated from a cabin that is not soundproof or if the cabin windows are open.
- ✓ Ensure that all warning labels are always visible and that none of them are missing, damaged or illegible.
- ✓ Check that all safety screens are correctly fitted and that there are no damaged or loose parts.
- ✓ Ensure that all hydraulic pipes and hoses are positioned correctly to avoid rubbing, stretching, pinching, or kinking damage to them.
- ✓ Check the work area and remove any rope, poles, large stones, and other dangerous objects before starting work.
- ✓ Drive at a safe speed that is tailored to the terrain and any other vehicles and obstacles.
- ✓ Make sure the vehicle is stable and meets the machine manufacturer's minimum weight recommendations - if necessary, use additional counterweight.
- ✓ Pay attention to power lines, if in doubt about the distance, contact the local power plant.
- ✓ It is recommended to use impact resistant screens on the vehicle.
- ✓ Check that the machine's fittings, screws, and couplings are in good condition.
- ✓ Follow the manufacturer's instructions for removing and installing the machine from the vehicle.
- ✓ Disconnect the hydraulics to the machine, stop the engine, pull the handbrake, and remove the key before leaving the cab.
- ✓ If necessary, remove nuisance material residues left behind from the area.
- ✓ Great care must be taken when inspecting, repairing, or doing other work on the stationary machine.
- ✓ Always use protective gloves, safety shoes, safety glasses and appropriate tools to perform the work.

3.7) Warnings on how the machine must not be used (h)

⚠ DANGER







The machine must never be used in the following ways:

- ✗ Do not operate the machine until relevant user manuals have been read and understood. Likewise, the operator must be familiar with the operating levers according to the user manual for the connected attachment tool!
- ✗ Do not operate the machine if there are others within the safety distances of the machine!
- ✗ Never let an inexperienced person operate the machine without supervision!
- ✗ Do not go inside the machine's working area / safety zone!
- ✗ Never try to locate a hydraulic leak by hand, use a piece of cardboard instead!
- ✗ Never allow children to play on or near the machine!
- ✗ Do not perform any maintenance or adjustment without first removing the hydraulic pressure from the machinery, lowering the Multi Carrier to the ground, stopping the vehicle engine, and applying the parking brake and removing the key!
- ✗ Do not use and/or mount the machine on a vehicle that does not comply with the manufacturer's specifications!
- ✗ Never use the machine if the hydraulic system shows signs of damage / defects!
- ✗ Do not stop the engine while the hydraulic pressure is activated!
- ✗ Never attempt to use the machine for any purpose other than that for which it is intended!
- ✗ Do not leave the vehicle cabin without removing the ignition key!
- ✗ Do not transport the machine while the hydraulic pressure to the attachment tool is activated!
- ✗ Do not use a machine that has not been maintained or if any of its screens are missing or damaged!
- ✗ Never operate the vehicle or any of the control levers from a position other than the driver's seat!
- ✗ Do not drive with mounted attachment tools where rotating parts are facing the cabin, as this entails the risk of stones and material residues being hurled at the driver!







3.8) Safety instructions for maintenance, adjustment, and inspection (s)

NOTICE

The machine must be maintained in the following ways:

-  The operator must ensure that all maintenance, inspection, and assembly work is carried out by authorized and qualified specialist personnel who, after thorough reading of relevant instruction materials, possess sufficient knowledge.
-  Maintenance, inspection, and assembly work may only be carried out with the hydraulics disconnected.
-  When carrying out maintenance work under the machinery etc., securing with suitable support elements must be carried out.
-  When replacing attachment tools, the hydraulic system is checked for residual pressure. A possible residual pressure is reduced to zero (0 bar / 0 psi).
-  Use only suitable tools and wear heavy-duty gloves, safety shoes and safety glasses.
-  Handle the hydraulic oil and grease according to regulations. Always be familiar with the safety data sheets.
-  Immediately after finishing work, all safety and protective devices must be installed and activated again.

3.9) Safety instructions for the operator / user

-  It is important to familiarize yourself with all operating elements and equipment and their function before starting the work. Once the work has started, it may be too late.
-  Check the immediate area before starting and during operation of the work the machine is to perform (people, children, animals, or obstacles, e.g., stones, fence posts, steel wire).
-  Ensure sufficient visibility and a well-lit work area. The safety distances specified in the attachment tool's user manual must be followed without fail.
-  The operator must be fresh and rested before using the machine, and take breaks when tired, to ensure his own safety and that of others.
-  The operator should ensure varying working positions and take frequent breaks to avoid disorders in the musculoskeletal system.
-  The operator must not leave the driver's seat while driving, and it is not permitted to have the attachment tool, or the Multi Carrier activated during transport.
-  When working near high-voltage lines, additional distance and caution are required.

4) Machine description (d)

4.1) Overview and features



GreenTec PUMA 3303 Multi Carrier variants

9993303L-50S

9993303R-50S

PUMA 3303 STANDARD (50 L/MIN.)
W. HYDRAULIC CUTTING ANGLE
LEFT / RIGHT

9993303L-50P

9993303R-50P

PUMA 3303 PLUS (50 L/MIN.)
W. E-REMOTE CONTROL
LEFT / RIGHT



8 tools

Hedge, tree, pruning and
fence maintenance



45°

Automatic impact protection
(AHS)



50 l/min.

Min. oil flow required



2-års garanti

High quality materials ensure
long life

The PUMA 3303 Multi Carrier extends the vehicle's horizontal reach and reduces time spent on landscape maintenance tasks.

The PUMA 3303 is the largest model in the Puma-series and is mainly mounted on telehandlers, large front-end loaders and excavators. Hedge cutting, fence trimming, tree pruning and mowing of barriers are easily done with this powerful, yet compact and versatile machine.

The Multi Carrier is supplied either in a standard version with hydraulic adjustment of the cutting angle and start/stop of the attachment tool, or in a Plus version with **electrically operated control of the cutting angle and start/stop of the attachment tool.**

The PUMA 3303 Multi Carrier has a reach of **2.5 m (8'3") (from the centre of the vehicle)**, a curb weight of **200 kg (441 lbs.)** and is characterized by its compactness and ability to easily navigate smaller areas, such as roadsides, paths, gardens, and parks. The machine is also suitable for contractors and farmers in larger green areas.

Automatic break-back system

Protects the machine from overloading
when cutting large material.

High safety

Control the machine from the cabin of
your vehicle. No risk of branches
falling on your vehicle.

Fast and easy installation

Utilize your vehicle throughout the
season and switch quickly between
attachment tools.

EQUIPMENT OVERVIEW:

Hydraulic cutting angle control *	✔ Standard
Mechanical switch from working to transport position	✔ Standard
Automatic impact protection with pre-pressure	✔ Standard
Oil flow divider	✔ Standard
Anti-cavitation valve	✔ Standard
Pressure relief valve	✔ Standard
1.5 m (4'11") hose kit to attachment tool	✔ Standard
Euro-bracket or universal-bracket	✔ Standard
E-remote control **	☐ Option
Counterweights (110 kg. / 243 lbs.)	☐ Option
8.5 m (27'11") hose kit (from front loader to tractor rear) - 3 pcs.	☐ Option
8.5 m (27'11") hose kit (from front loader to tractor rear) - 5 pcs.	☐ Option
Other bracket types	☐ Option

* PUMA 3303 Standard only: Hydraulic angle control requires 2 x DA hydraulic outlets on the vehicle.

** PUMA 3303 Plus only: Delivered with hydraulic cutting angle adjustment and electro-hydraulic remote control (incl. oil flow divider), there is only a need for 1 x DA hydraulic outlet (incl. pressureless drain where required)

Table 7 – Overview of equipment

NOTICE

See the section in the user manual about [optional equipment](#) – page 29-30 and get more information about the different options for the machine on GreenTec's [webpage](#).

4.2) Use of the machine

4.2.1) Intended use of the machine (g)

NOTICE

For any use of the machine other than that described in this section, GreenTec is not liable for damages as a result. The risk then rests solely with the operator and/or the user.

The PUMA Multi Carrier-series is available in several different sizes, but they all have the same basic construction and operation, and their intended use are therefore the same. The machine is used to carry out the work of grass mowing, hedge cutting, shelterbelt maintenance and cleaning of pavements.

See the machine specifications for attachment tools intended for use with the PUMA 3303 Multi Carrier. ([Specifications](#) – page 31)

4.2.2) Application and restrictions of the machine (h)

In combination with an approved attachment tool, the PUMA 3303 Multi Carrier can be mounted as front mounted on various vehicles such as telehandlers, large front- end loaders and excavators.

Minimum unladen weight of the vehicle allowed, depends on the model and size of the Multi Carrier- /attachment tool combination.

GreenTec designs many different types of suspensions, loader brackets and adapters for many different vehicles.

The capacity of the machine depends on the specifications of the attachment tool used, the hydraulic pressure it is supplied with, the type and amount of material to be processed and the speed at which it is driven.

⚠ DANGER

The owner of the machine / operations manager is responsible for observing the following rules:

- The vehicle on which the machine is mounted must meet the requirements for machines approved for agriculture.
- All safety values must under no circumstances be exceeded. (Safety distances, pressure, flow, RPMs, etc.)
- Never use the machine with an attachment tool without fitted guards.
- The machine must never be used to transport people, animals or other equipment than described in this user manual. The Multi Carrier and/or attachment tool must never be used as a "crane" or other form of lifting equipment.
- That the stability of the supporting vehicle is sufficient. See section: [Stability \(o\)](#) – page 44-45, as well as the user manual for the attachment tool and vehicle used.

⚠ DANGER

Safety shields on the used attachment tool can never work 100%!

Depending on the driving conditions, there will be a possibility that serious fragments/material can come flying and damage people or equipment.

Always keep your distance!

4.3) Components of the machine

4.3.1) Steel main frame w. swing arm

The main frame of the PUMA 3303 Multi Carrier incl. swing arm is constructed in strong steel elements, where all parts of the machine are manufactured and dimensioned for the impacts that occur during use.

The swing arm is always unfolded mechanically from the transport position to the working position, with the option of either mechanical, hydraulic, or electro-hydraulic operation of the cutting angle with start/stop of the attachment tool.

The PUMA 3303 Multi Carrier is designed with the routing of hoses inside the swing arm itself, for greater safety and ease of use in terms of mounting and connecting the machine.

There are also mounted protective shields that prevent accidental contact with the hydraulic valve, accumulator, hydraulic connections, as well as protection of critical components from external dirt, shocks, etc.

4.3.1.1) Support feet

There are 3 solid support feet installed on the PUMA 3303 Multi Carrier that contribute to easy, stable and safe removal and mounting of the Multi Carrier on the vehicle.

The support feet also ensure that the PUMA 3303 Multi Carrier is stable, during storage and possibly service and maintenance.



PUMA 3303 Multi Carrier in use with HX 230 Cutterbar

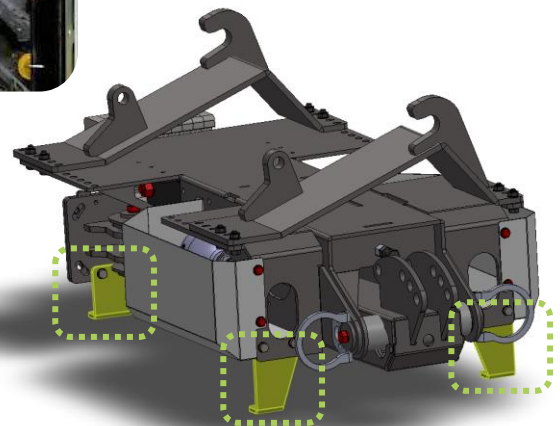

4.3.2) Hydraulic cutting angle adjustment

As standard equipment on the PUMA 3303 Standard-version, a hydraulic cylinder is mounted on the outer bracket of the swing arm.

(On the PUMA 3303 Plus-version, this function is integrated into the e-control of machine!)

The operator has the option to easily adjust the cutting angle of the attachment tool, in order to achieve the best possible cutting result, in relation to the material that the machine is working with.

With hydraulic cutting angle adjustment, the outer bracket on the swing arm can be hydraulically adjusted between approx. -20° (vertical position) to approx. 90° (horizontal position)

NOTICE

For PUMA 3303 Standard-models, the hydraulic cutting angle adjustment requires an additional 1 x DA outlet from the vehicle. From here, the angle of the attachment tool is adjusted via the vehicle's own hydraulic control.

Always refer to the user manual for the vehicle used!

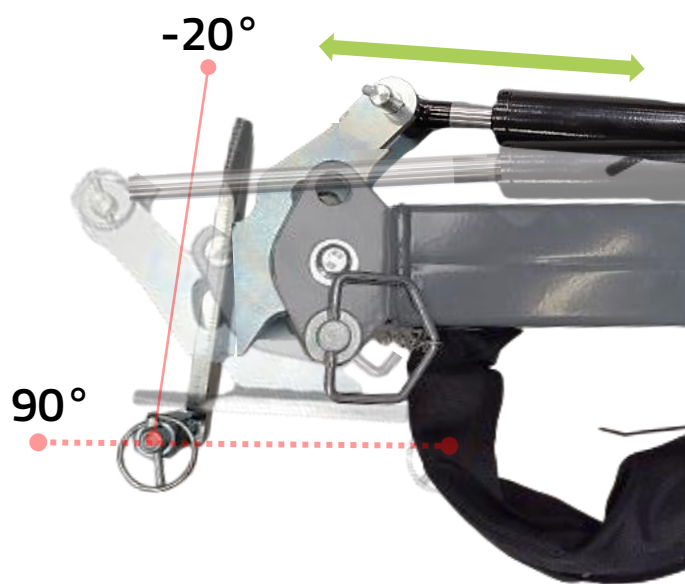

Hydraulic cutting angle adjustment on PUMA 3303 Multi Carrier



PUMA 3303 Multi Carrier with LRS 2002 Quadsaw in vertical position



PUMA 3303 Multi Carrier with LRS 2002 Quadsaw tilted towards a horizontal position

4.3.3) Automatic hydraulic impact protection (AHS)

The PUMA 3303 Multi Carrier has an automatic hydraulic impact protection (AHS), which also functions as a pre-pressure for attachment tools, such as the LRS Quadsaw.

The impact protection is an enclosed hydraulic circuit, consisting of a cylinder connected to an accumulator. The cylinder acts as a shock absorber against the back pressure of the accumulator.

The same back pressure from the accumulator subsequently ensures that the cylinder gently falls back to its starting- /working position after obstacles are surpassed.

The arm system of the PUMA 3303 Multi Carrier can swing back, at an angle of up to 45°, and only when driving in forward direction.

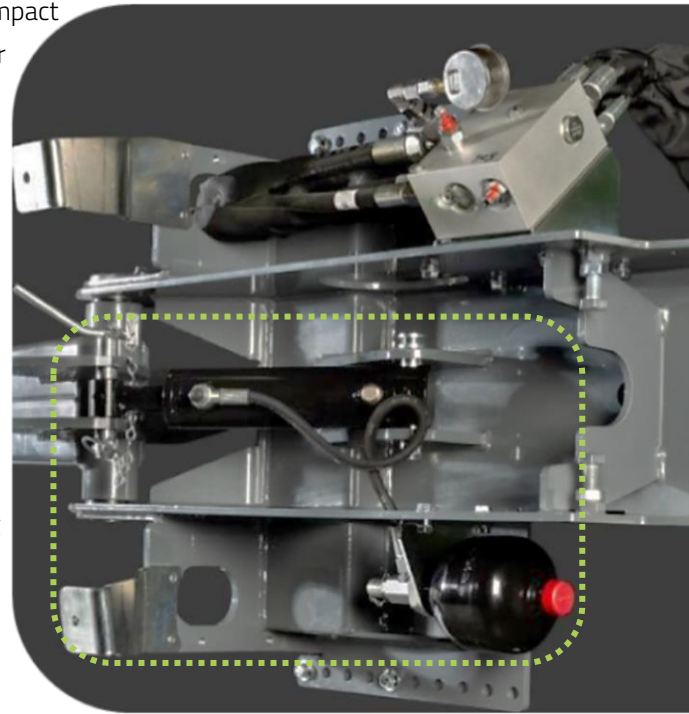

Accumulator connected to impact cylinder



The automatic hydraulic impact protection (AHS) works as a closed circuit under high pressure. (50 bar / 725 psi)

The impact protection cylinder is thereby under constant pressure from the accumulator.

DATA: AUTOMATIC HYDRAULIC IMPACT PROTECTION (AHS)

Filler:	Nitrogen
Amount:	0.75 l (25.36 fl. oz)
Charge pressure:	50 bar (725 psi)
Pre-charge:	32 bar (464 psi)
Compression ratio:	1,56:1
Re-filling:	Re-fillable w/ nitrogen: * (Minimess size: M16 x 1.5)

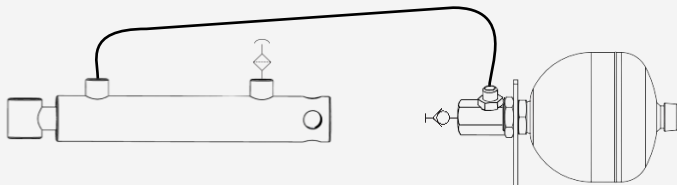

* The accumulator only needs re-filling if pressure is lost due to disconnecting by fault etc. See section: [Re-filling the accumulator](#) – page 71.

Table 8 – Data sheet: Automatic hydraulic impact protection (AHS)

4.3.3.1) Function of the automatic hydraulic impact protection (AHS)

The swingarm system on the machine has a built-in automatic hydraulic impact protection: ("Break back"-function). The system helps to ensure against mechanical overload of the arm and the machinery during use.

When the attachment tool on the Multi Carrier hits a tree or other fixed obstacle, the arm system's impact cylinder will relieve the pressure on the structure by allowing the arm system to move backwards:

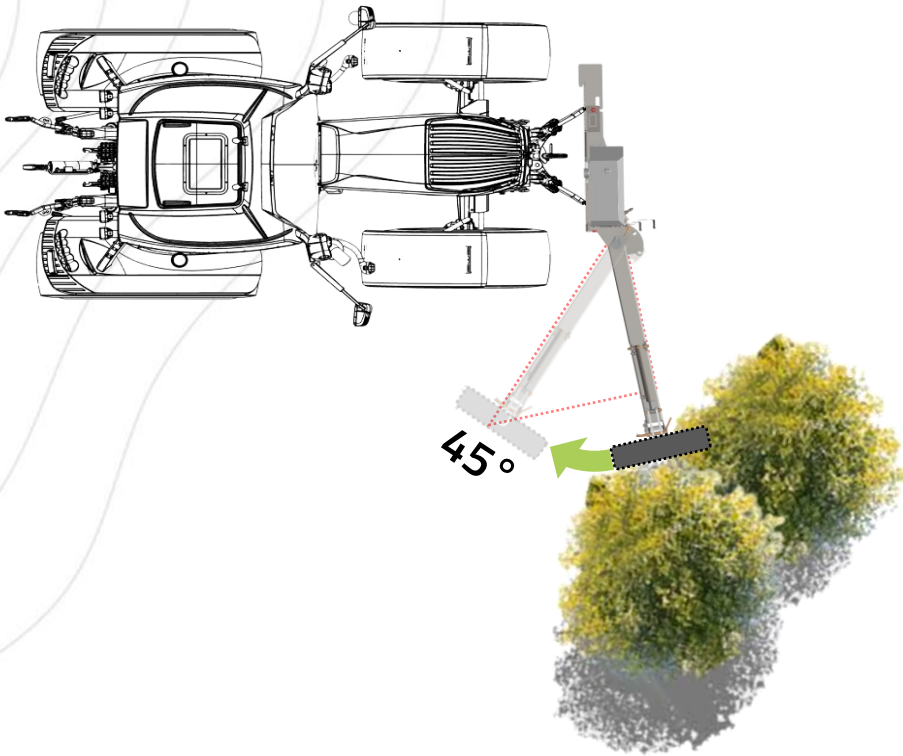

⚠ WARNING

The impact protection only works until the bottom/stop of the movement of the impact cylinder is reached!

If the impact continues after that, the arm can be damaged, as the load during impact is thereby transferred directly to the Multi Carrier.

The impact protection on the PUMA 3303 Multi Carrier is therefore only active in what corresponds to the cylinder's total exchange rate.

See section: [Driving instructions](#) – page 58-60.

⚠ CAUTION

The impact protection can also be triggered inappropriately if the attachment tool is overloaded, either as a result of too high forward speed in relation to the amount of material being processed, if the attachment tool is pressed too hard against the ground, or when working uphill / on slopes.

When the arm is pushed backwards in the event of an impact, the arm itself falls back into its original position.

The impact protection does not exempt the operator from liability.

Be aware of dangerous objects and avoid hazards. It is up to the operator to ensure that the machine has a long life and reliable operation.

4.3.4) Oil flow divider with overpressure- and anti-cavitation valve

4.3.4.1) PUMA 3303 Standard (without e-control)

The oil flow divider on the PUMA 3303 Standard Multi Carrier, ensures that the correct oil flow and pressure is sent from the vehicle's hydraulic outlet to the mounted attachment tool.

The oil flow divider has a built-in overpressure and anti-cavitation valve:

- Overpressure valve for securing and maintaining the preset system pressure for the machinery.
- Anti-cavitation valve to minimize the risk of cavitation damage in connection with pressure fluctuations and/or insufficient inlet pressure.

NOTICE

These built-in valves between the pressure and return ports open/close to ensure a constant flow of oil to the motor of the attachment tool and/or against overloading of the same.



Oil flow divider: PUMA 3303 Standard Multi Carrier

The oil flow divider on the PUMA 3303 Standard version, works by connecting an oil flow of minimum 50 l/min (13.21 gpm) from the vehicle's oil outlets, and for some attachment tools, an external non-pressurized drain connection through its own port: (D) The oil flow divider also connects the cutting angle adjustment from the vehicle using its own ports: (C1/C2). See section: [Hydraulic cutting angle adjustment](#) – page 20.

DATA: OIL FLOW DIVIDER

Connection:	1 x DA: Pressure and return (incl. pressureless drain) 1 x DA: Hydraulic cutting angle adjustment
Operating pressure (continuous):	Min. 50 l/min @ 180 bar (13.21 gpm @ 2610 psi) *
• Recommended return pressure (continuous):	5 bar (72.52 psi) *
• Max. allowed return pressure (peak):	15 bar (217.56 psi) for att. tools w/ external drain * 25 bar (362.59 psi) for att. tools w/o external drain.
• Max. allowed drain pressure (peak):	2 bar (29 psi) *
Seal type:	NBR
Operating temperature:	-30... +100 °C (-22... +212 °F)

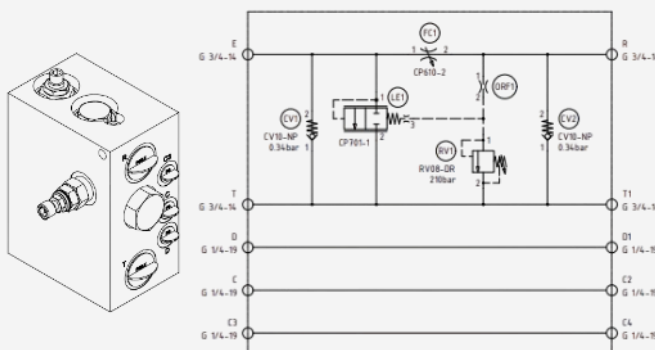

* Pay particular attention to the performance of the vehicle's oil outlets and connection of the external drain connection. The recommended specifications for especially return and drain pressure on the hydraulic motor must not be exceeded. This can result in serious damage to the hydraulic motor if the regulations for oil flow and pressure are not strictly followed.

Table 9 – Data sheet: Oil flow divider (PUMA 3303 Standard)

4.3.4.2) PUMA 3303 Plus (with e-control)

The oil flow divider on the PUMA 3303 Plus Multi Carrier has exactly the same operating specifications as on the Standard-version of the machine, but with the addition of electronic remote control of selected functions.

The electronic functions on the oil flow divider, using a receiver + wireless remote control, allow for adjustment of both the cutting angle and start/stop of the attached tool.

See section: [Setting and adjusting the machine \(r\)](#) – page 54-57.

NOTICE

The PUMA 3303 Multi Carrier is offered in either a Standard or Plus version.
It is not possible to retrofit e-control with wireless remote control on a Standard edition of PUMA 3303 Multi Carrier.

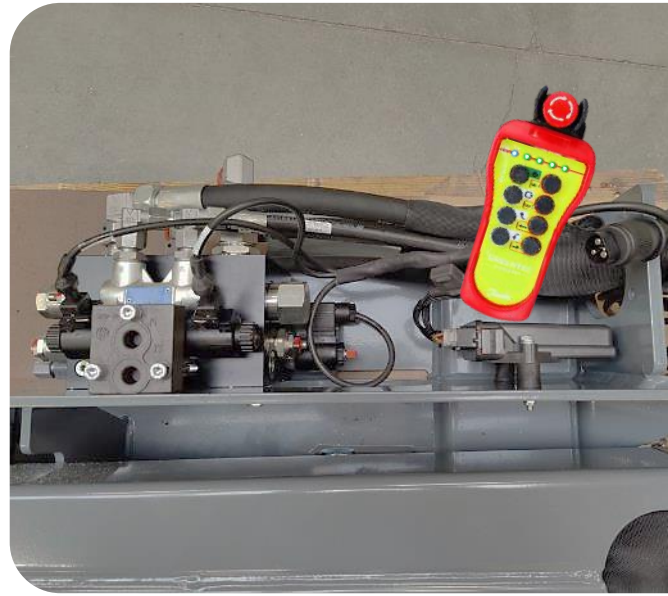

Oil flow divider w. e-control: PUMA 3303 Plus Multi Carrier

The oil flow divider on the PUMA 3303 Plus edition works by connecting an oil flow of minimum 50 l/min (13.20 gpm) from the vehicle's oil outlets incl. an external pressureless drain connection, *bypassing the oil flow divider*.

DATA: OIL FLOW DIVIDER W. E-CONTROL

Connection:	1 x DA: Pressure and return (incl. external pressureless drain)
Operating pressure (continuous):	Min. 50 l/min @ 180 bar (13.20 gpm @ 2610 psi) *
<ul style="list-style-type: none"> Recommended return pressure (continuous): 	5 bar (72.52 psi) *
<ul style="list-style-type: none"> Max. allowed return pressure (peak): 	15 bar (217.56 psi) for att. tools w/ external drain * 25 bar (362.59 psi) for att. tools w/o external drain.
<ul style="list-style-type: none"> Max. allowed drain pressure (peak): 	2 bar (29 psi) *
Seal type:	NBR
Operating temperature:	-30... +100 °C (-22... +212 °F)

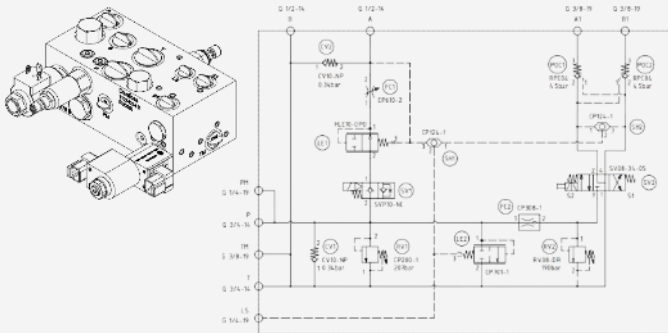

* Pay particular attention to the performance of the vehicle's oil outlets and connection of the external drain connection. The recommended specifications for especially return and drain pressure on the hydraulic motor must not be exceeded. This can result in serious damage to the hydraulic motor if the regulations for oil flow and pressure are not strictly followed.

Table 10 – Data sheet: Oil flow divider w. e-control (PUMA 3303 Plus)

4.3.5) 1,5 m (4'11") hose-kit

The PUMA 3303 Multi Carrier is intended for mounting on the front of vehicles, and a complete hose set of 1.5 m incl. hydraulic quick couplings for connection between the vehicle's hydraulic system and the Multi Carrier

The standard hose-kit consists of 3 types of hoses: **Pressure-**, **return-** and **drain-**hose, incl. various screw connections, fittings, rubber plugs and hose protection.

For PUMA 3303 Multi Carrier Standard-models with **hydraulic cutting angle adjustment**, 2x additional hydraulic hoses are included for connection from the vehicle to the Multi Carrier's oil flow divider.



1,5 meter hose-kit for PUMA 3303 Multi Carrier

NOTICE

The hydraulic quick couplings on the hoses, require that there are also fitting outlets for these on the vehicle. See section: [Mounting and connecting the PUMA 3303 Multi Carrier to the vehicle](#) – page 38-42.

DATA: 1.5 M (4'11") HOSE-KIT

Length(s):	3x: 1560 mm (4'11")
Hose protection:	Textile sleeve 120/Ø75 (4.72"/Ø2.95")
Size(s):	
• P-hose (Pressure):	1/2" (Hydr. quick coupling: 1/2" – L15 (M22 x 1,5))
• T-hose (Return):	3/4" (Hydr. quick coupling: 1/2" – L18 (M26 x 1,5))
• D-hose (Drain):	3/8" (Hydr. quick coupling: 1/2" – L12 (M18 x 1,5))
• Optional equipment (Cutting angle adjustment): *	1/4" x 2 (Hydr. quick couplings: 1/2" – L10 (M16 x 1,5))

** Only for PUMA 3303 Standard version: 2 x DA hydraulic outlets are required on the vehicle!
Not needed on PUMA 3303 Plus-version, as function is integrated into the e-control of machine!*

Table 11 – Data sheet: 1.5 m (4'11") hose-kit

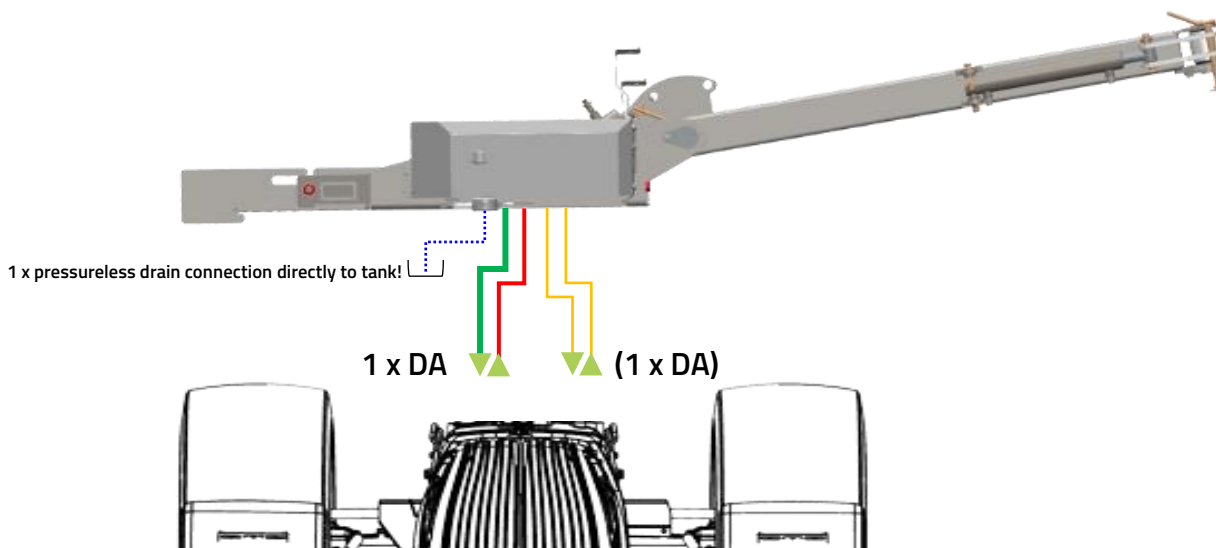

Hydraulic hose connections between PUMA 3303 Multi Carrier and vehicle

4.3.6) Loader brackets for mounting on vehicles

The PUMA 3303 Multi Carrier comes standard with either a **Euro hitch- or a universal bracket (blank plates)**.

The loader brackets are used for mounting on front loaders- /mini loaders and in addition to the standard brackets, there are many different brackets adapted to different types of the most popular vehicles/manufacturers.

The overview below shows the available loader brackets for different vehicles, for mounting with the PUMA 3303

Multi Carrier:

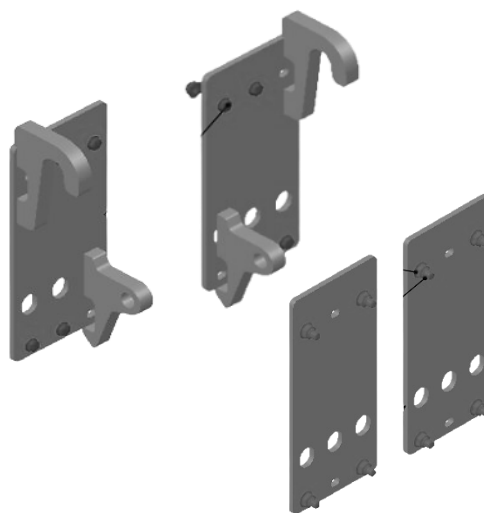

Euro hitch- and universal (blank plates) loader brackets

NOTICE

When ordering, the vehicle model must be specified so that the machine is delivered with suitable loader fittings.

LOADER BRACKETS: *

OPTE4051	PUMA 3303 ↔ Skid steer
OPTE4059	PUMA 3303 ↔ CAT Tele
OPTE4251	PUMA 3303 ↔ Kramer spec.
OPTE4272	PUMA 3303 ↔ Universal (blank plates)
OPTE4281	PUMA 3303 ↔ MX Mailleux
OPTE7010	PUMA 3303 ↔ Bobcat Tele
OPTE7011	PUMA 3303 ↔ Case IH Farmlift
OPTE7012	PUMA 3303 ↔ Claas Tele
OPTE7013	PUMA 3303 ↔ Euro hitch
OPTE7014	PUMA 3303 ↔ JCB Q-Fit
OPTE7015	PUMA 3303 ↔ JLG-Deutz
OPTE7016	PUMA 3303 ↔ Kramer (small model)
OPTE7018	PUMA 3303 ↔ Manitou
OPTE7019	PUMA 3303 ↔ Merlo ZM3
OPTE7020	PUMA 3303 ↔ Merlo Tele
OPTE7021	PUMA 3303 ↔ Merlo ZM2
OPTE7022	PUMA 3303 ↔ New Holland
OPTE7023	PUMA 3303 ↔ Terex TL 80-100-120
OPTE7024	PUMA 3303 ↔ Trima-Ville
OPTE7025	PUMA 3303 ↔ Volvo (high model)
OPTE7026	PUMA 3303 ↔ Volvo (low model)
OPTE7027	PUMA 3303 ↔ Schäffer Tele
OPTE7029	PUMA 3303 ↔ New Holland LB 115

* When a new PUMA 3303 Multi Carrier is delivered, the vehicle where the machine is to be mounted may need to be adapted for installation with adapter brackets!

Table 12 – Loader brackets for PUMA 3303 Multi Carrier



4.4) Approved attachment tools and optional equipment (n)

⚠ WARNING

Remember that when mounting with attachment tools and equipment other than GreenTec produced or approved, it is the responsibility of each operator to ensure that the vehicle and the overall machinery comply with the applicable requirements and relevant directives!

For installation with attachment tools other than those approved by GreenTec, a new risk assessment of the machinery and equipment used must be submitted!

The reliability of the machine can only be guaranteed if it is used according to its intended use!

Installing the machine with an unapproved attachment tool invalidates the risk assessment basis, the validity of the declaration of conformity and the machine warranty!

The PUMA 3303 Multi Carrier is designed for installation with the following approved GreenTec attachment tools and optional equipment:

APPROVED ATTACHMENT TOOLS:	
LRS 2002 Quadsaw	✓ Approved
LRS 2402 Quadsaw	✓ Approved
RC 162 Rotary Hedge Cutter	✓ Approved
HX 170 Cutterbar	✓ Approved
HX 230 Cutterbar	✓ Approved
HX 270 Cutterbar	✓ Approved
HS 212 Cutterbar	✓ Approved
HS 242 Cutterbar	✓ Approved
APPROVED OPTIONAL EQUIPMENT:	
Counterweights (110 kg. / 243 lbs.)	✓ Approved
8.5 m (27'11") hose kit (from front loader to tractor rear) - 3 pcs.	✓ Approved
8.5 m (27'11") hose kit (from front loader to tractor rear) - 5 pcs.	✓ Approved
Other bracket types	✓ Approved
OTHER MANUFACTURERS:	
N/A	

Table 13 – Approved attachment tools and optional equipment

4.5) Optional equipment

4.5.1) Counterweights (110 kg. / 243 lbs.)

A set of counterweights (110 kg. / 243 lbs.) can be mounted as optional equipment on the PUMA 3303 Multi Carrier

The set of counterweights consists of 9 pcs. weight blocks of 12 kg. (26.95 lbs.) each incl. brackets and various loose parts for mounting onto the Multi Carrier itself.

The installation of the counterweights is secured with a through bolt and lock nut.

The weight blocks are galvanized and therefore have good corrosion resistance and abrasion resistance against the environment.

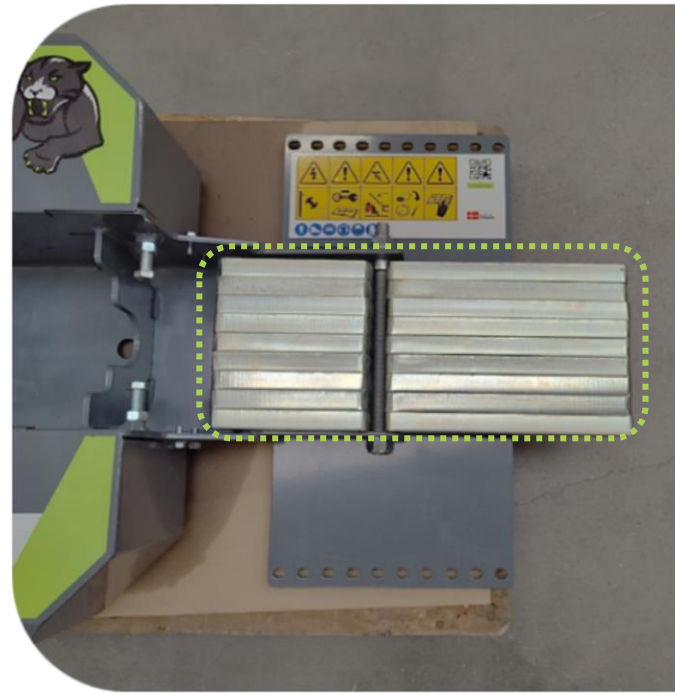

Counterweights (110 kg. / 243 lbs.) mounted on PUMA 3303 Multi

⚠ WARNING

Always ensure that the vehicle is stable and meets the machine manufacturer's recommendations on minimum weight. Before use, there must always be a check to see if the stability of the Multi Carrier is sufficient, incl. the carrying vehicle! See section: [Stability \(o\)](#) – page 44-45.

DATA: COUNTERWEIGHTS

Amount:	9 pcs. of 12 kg. (26.95 lbs.)
Weight (total):	110 kg. (243 lbs.) (incl. brackets and bolts)
Material:	Structural steel: S235
Surface treatment:	Galvanized (Blue)

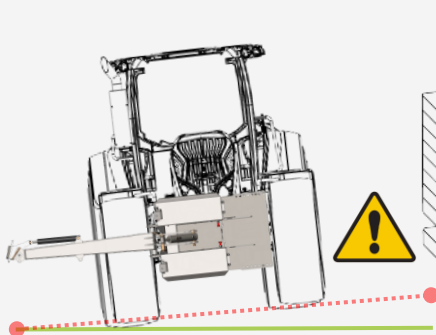

* Depending on the weight and stability of the vehicle used with the Multi Carrier and attachment tool, counterweights on the Multi Carrier may be necessary to maintain stable front axle pressure on the opposite wheel from which the attachment tool is mounted.

Table 14 – Data sheet: Counterweights (110 kg. / 243 lbs.)

4.5.2) 8.5 m (27'11") hose kit (from front loader to tractor rear) - 3 pcs. or 5 pcs.

The PUMA 3303 Multi Carrier is intended for mounting on the front of vehicles, but as an option a complete hose set of 8.5 m (27'11") incl. quick couplings for connection between the hydraulic system at the rear of the vehicle and the PUMA 3303 Multi Carrier.

The standard hose set consists of 3 types of hoses:

Pressure-, return- and drain-hose, incl. various screw connections, fittings, rubber plugs and hose protection.

For PUMA 3303 Multi Carrier Standard-models with hydraulic cutting angle adjustment, 2x additional hydraulic hoses are included for connection from the vehicle to the Multi Carrier's oil flow divider.



8.5 m (27'11") hosekit for PUMA 3303 Multi Carrier

NOTICE

The hydraulic quick couplings on the hoses, require that there are also fitting outlets for these on the vehicle. See section: [Mounting and connecting the PUMA 3303 Multi Carrier to the vehicle](#) – page 38-42.

DATA: 8.5 M (27'11") HOSE KIT

Length(s):	3x: 8675 mm (27'11")
Hose protection:	Textile 150/Ø90: 8400mm (5.91"/Ø3.54")
Size(s):	
• P-hose (Pressure):	1/2" (Hydr. quick coupling: 1/2" – L15 (M22 x 1,5))
• T-hose (Return):	3/4" (Hydr. quick coupling: 1/2" – L18 (M26 x 1,5))
• D-hose (Drain):	3/8" (Hydr. quick coupling: 1/2" – L12 (M18 x 1,5))
• Optional equipment (Cutting angle adjustment): *	1/4" x 2 (Hydr. quick couplings: 1/2" – L10 (M16 x 1,5))

* Only for PUMA 3303 Standard version: 2 x DA hydraulic outlets are required on the vehicle!

Not needed on PUMA 3303 Plus-version, as function is integrated into the e-control of machine!

Table 15 – Data sheet: 8.5 m (27'11" ft) hose kit

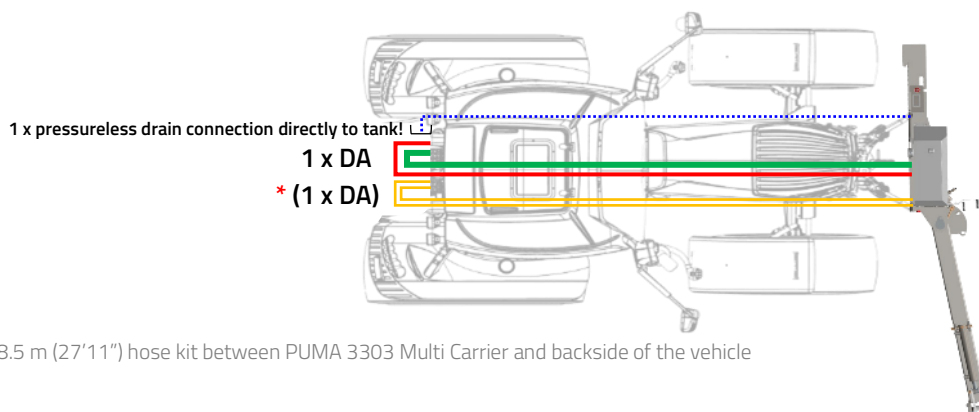

8.5 m (27'11") hose kit between PUMA 3303 Multi Carrier and backside of the vehicle

4.6) Specifications

DATA: PUMA 3303 MULTI CARRIER	
Transport width (w/o. att. tool):	1650 mm (5'5")
Reach: (from mid-machine w/ att. tool):	2500 mm (8'3")
Depth:	350 mm (13.78")
Height:	750 mm (29.53")
Weight:	200 kg. (441 lbs.)
Recommended weight (vehicle):	(Always see section: Stability (o) – page 44-45)
Required oil outlets:	Minimum 1 x DA (pressure and return) + external non-pressurized drain connection.
Oil requirements:	Minimum 50 l/min @ 180 bar (13.20 gpm @ 2610 psi) *
<ul style="list-style-type: none"> Recommended return pressure (continuous): 	5 bar (72.52 psi) *
<ul style="list-style-type: none"> Max. allowed return pressure (peak): 	15 bar (217.56 psi) for att. tools w/ external drain. 25 bar (362.59 psi) for att. tools w/o external drain.
<ul style="list-style-type: none"> Max. allowed drain pressure (peak): 	0-2 bar (0-29 psi) *
(AHS) Automatic Hydraulic Safety-circuit:	Enclosed hydraulic system @ 50 bar. Accumulator w/ pre-charged pressure (nitrogen) @ 32 bar
Driving speed:	Max. 5 km/h (3.10 mph)
Working season:	All year.
A-weighted sound level:	Not above >84 dB
Materials:	Structural steel: S235 Hydraulic hoses: Steel reinforced rubber coated Other components: Cast iron and aluminium
Paint:	Grey (Gloss 70-80) = RAL 7011 (Iron Grey) 
Lubrication:	See section: Lubrication of the machine – page 73. Type: Texaco Multifak® T EP 2 lithium-grease or equivalent

Table 16 – Data sheet: Machine specifications

WARNING

* The oil supply from the Multi Carrier to the attachment tool in-use, needs a minimum return line pressure to ensure correct working conditions.

It is recommended to always have a return pressure of up to 5 bar (72.52 psi) on the return line at the oil motor. The drain pressure on the oil motor must never exceed the return pressure.

If the drain line pressure gets higher than the return line pressure while using the machine, the oil motor will be damaged and the warranty for this will be void.

4.7) Noise measurement of airborne noise (u)

Noise measurements were carried out on the machine under normal operating conditions at GreenTec A/S in Denmark, with a Delta OHM sound meter - type HD 8701.

Measurements were carried out 1 meter from the machine's critical noise generators (rotors/blades) at a height of 1.60 meters (5.25 ft.) from the ground, with starting and using the attachment tool.

Noise level changes in relation to the season and the material being processed; therefore, the noise level may differ to a lesser extent.

The Multi Carrier's noise level will always be lower than the noise level from the attachment tools, as well as the noise from the vehicle in use.

Always follow the precautions intended for the attachment tool and Multi Carrier and/or vehicle used.

See section: [Safety](#) – page 6-15.

A-WEIGHTED SOUND POWER LEVEL >80 DB

PUMA 3303 Multi Carrier

Less than < 85 dB(A)

Table 17 – Measurement of A-weighted sound power level

5) Instructions for using the machine (k)

5.1) GreenTec.eu – Explore and learn!

On GreenTec's website there is the section: "Explore and learn":

<https://greentec.eu/explore-learn/>

The page contains useful videos and other guidance material on how to use your GreenTec machines as best as possible.

The "Explore and Learn" page can be used as an interactive supplement to the user manual for the machine, with e.g., video guides and articles regarding practical use and maintenance of your GreenTec machine.

Whether you are just starting out or a seasoned professional with GreenTec's machines, the "Explore and Learn" page can be useful for anyone who wants to learn more about their attachment tools and/or Multi Carriers.

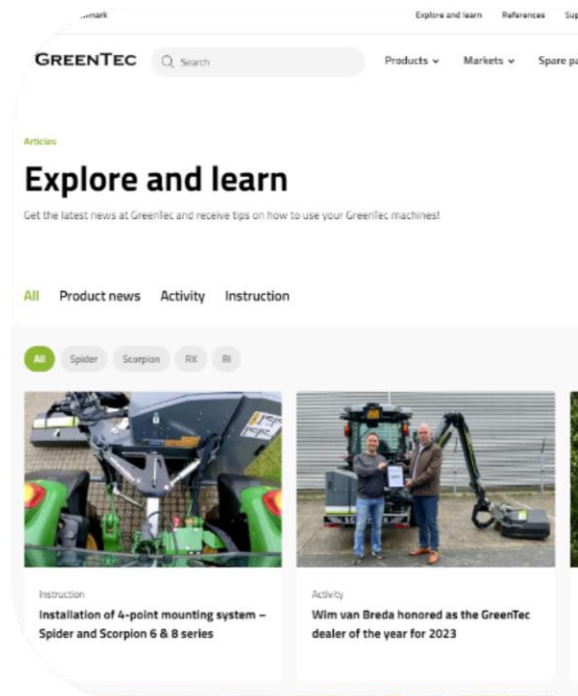

Explore and learn page on GreenTec's website

5.2) GreenTec.eu – FAQ

On GreenTec's website there is the section "FAQ":

<https://greentec.eu/support/faq/>

The page contains a collection of the most frequently asked questions regarding technology, use, service, and maintenance of GreenTec machines and equipment.

The "FAQ" page can also be used as a supplement and reference work together with the user manual for the GreenTec machine.

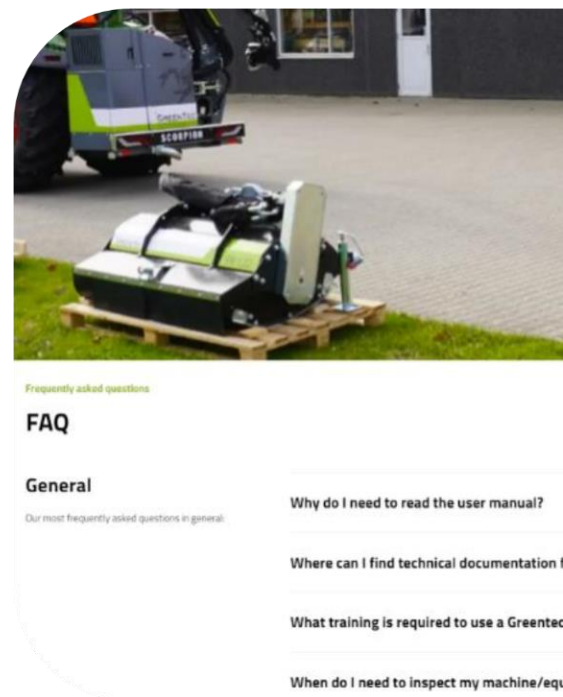

The FAQ page on GreenTec's website

5.3) Instructions regarding delivery of the machine

Upon delivery of the GreenTec machine, the following is immediately checked:

1. Check the machine and all included parts for transport damage.
In case of transport damage, please follow the instructions in the section: [Transport damage](#) – page 34.

NOTICE

If there are any shortages, defects or transport damage upon delivery, contact the GreenTec dealer immediately!



Example of pallet delivery with PUMA 3303 Multi Carrier

2. Check that the following components are included with the PUMA 3303 Multi Carrier:

CHECKLIST UPON DELIVERY (PER MACHINE):

1x PUMA 3303 Multi Carrier	Incl. optional equipment. *
3x Support feet	In box incl. steel set screws.
1x Remote control	In box incl. loose parts. (Only on PUMA 3303 Plus)
1x Hose-kit + fittings	3x hoses: Pressure , return and drain . (Only on PUMA 3303 Standard): 2x hoses for hydraulic cutting angle adjustment .
1x Loader bracket for mounting	Right and left brackets for mounting on selected vehicles.
1x User manual	Digital QR code on the machine. (Physical copy optional upon purchase)
1x Spare parts book	Digital QR code on the machine. (Physical copy optional upon purchase)

* Counterweights chosen as optional equipment, are mounted on the machine upon delivery.

Table 18 – Checklist for delivery of machine

5.3.1) Transport damage

Upon delivery of the machine, both the machine and accompanying equipment are immediately checked for visible signs of transport damage.

If a machine and/or equipment with transport damage is received, it is important that an objection is immediately made to the condition of the shipment, and that **the receipt is signed off with reservations!**

NOTICE

If it is not noted that the item is damaged or is received with reservations, it is received as undamaged upon delivery, and all compensation claims are waived.

GreenTec is not liable for damages incurred during transport. The carrier, on the other hand, is liable for damages.

Contact your dealer immediately if damaged goods have been received, or if the shipment is rejected because it is damaged.

5.4) Instructions for mounting, connecting, and disconnecting (j)

Initial mounting and connection of the machine should always be carried out by the dealer with the necessary knowledge and experience!

When the PUMA 3303 Multi Carrier is mounted for the first time with an approved attachment on the vehicle, in some cases it may be necessary to make further adjustments, especially in relation to stabilization - this should also be carried out at the dealer of the machine.

See section: [Preparing the machine for use](#) – page 43-47.

DANGER

The instructions for the machine must be completely understood before any attempts are made to mount, connect, or use the machine. If in doubt, contact the dealer of the machine!

WARNING

When mounting and connecting with attachment tools other than those produced or approved by GreenTec, it is every operator's own responsibility to ensure that the vehicle and the assembled machinery meet the applicable requirements and relevant directives for this!

When mounting with other makes of attachment tools than specified by GreenTec, a new risk assessment of machines and equipment must be submitted before use!

If any unapproved attachment tool is mounted onto the Multi Carrier, the basis for risk assessment ceases, and thereby the validity and guarantee of the declaration of conformity!

5.4.1) Preparation of vehicle and operator

Before Multi Carrier, attachment tools and other machinery are put into use, it is important that the vehicle incl. operator is properly prepared. This must be done both to achieve maximum safety and to ensure optimal operation during use.

As extra security, safety glass/windows (polycarbonate), safety nets and/or other protective devices can be fitted to the vehicle when it is used together with GreenTec's machines.

In general, the driver of the vehicle should always use safety equipment to reduce the risk of serious injuries such as:

- Eye protection: Net/visor (EN ISO 16321-3:2022) and/or safety glasses (EN ISO 16321-1:2022)
- Hearing protection (EN 352-1:2020), safety helmet (EN 397 + A1:2012), gloves and visible work clothes.

If the vehicle does not have a cab, safety glasses/shields, hearing protection and a helmet must be used:

- Bare skin should be protected with suitable thick clothing against possible plant debris that can hit the driver of the vehicle. See section: [Personal safety equipment](#) – page 6.

5.4.2) Preparation of PUMA 3303 Multi Carrier (Initial start-up)

Before the PUMA 3303 Multi Carrier is ready for assembly and use, all sub-components must be mounted and/or adjusted correctly to achieve both maximum safety and to ensure optimal operation during use.

The PUMA 3303 Multi Carrier is supplied with loose components that must be mounted on the machine. This applies to both the loader brackets for mounting, support feet and the hydraulic hose kit.

The machine is immediately ready for mounting and connection immediately after the following steps:

PREPARATION OF PUMA 3303 MULTI CARRIER:

1. The loader brackets for mounting to the vehicle are bolted to the back plate of the Multi Carrier using the supplied bolts, washers and nuts:

(PICTURE)

Bolts are tightened according to [Table 32](#) – page 66.

2. Slowly adjust and carefully drive the front loader into the loader bracket on the PUMA 3303 Multi Carrier. The vehicle is carefully steered so that the front loader is driven into the hooks on the bracket.



3. Make sure that the hooks from the loader bracket have a firm grip on the front loader frame and make sure that holes and locking pins are flush, before locking the front loader locking mechanism to secure the Multi Carrier onto the loader frame. The PUMA 3303 Multi Carrier is now mechanically mounted.



4. Carefully begin to lift the PUMA 3303 Multi Carrier into its working position. Transport brackets fitted upon delivery are removed and replaced with the correct support legs (3 pcs.). These are included in the box with screws etc.



5. Hydraulic hoses are mounted onto the PUMA 3303 Multi Carriers oil flow divider, for connection between the Multi Carrier and the vehicle:

E (Entry) = Pressure

T1 (Tank) = Return

D1 (Drain) = Drain

C1 / C2 = Hydraulic cutting angle adjustment *

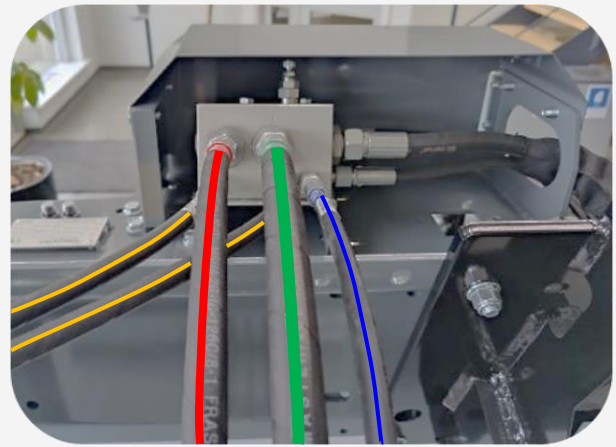

* Optional equipment on PUMA 3303 Standard only! Not needed on PUMA 3303 Plus, as function is integrated into the e-control of machine!

Table 19 – Preparation of PUMA 3303 Multi Carrier

NOTICE

Always pay attention to the above designations (E, T1, D1 and C1 / C2) at the inputs of the oil flow divider when preparing the Multi Carrier for connection to the vehicle.

Fittings for all connected hydraulic hoses are dimensioned in different sizes on the oil flow divider to prevent misconnections between the Multi Carrier and the vehicle.

5.4.3) Mounting and connecting the machine (i)

The mounting and connection procedure may differ from vehicle to vehicle! For this, always use the instructions of the vehicle used in combination with the instructions of the Multi Carrier.

Assembly on different types of vehicles with different Multi Carriers are broadly the same procedure, but always investigate the procedure for the combination of machines used on your own.

Common to all GreenTec Multi Carriers are that these are mounted onto the vehicle by the loader brackets bolted onto the backside of the Multi Carrier. Depending on which loader bracket is used, these must be mounted depending on the vehicle.

⚠ DANGER

Never use the Multi Carrier with a mounted attachment tool on an unstable or unsuitable vehicle!

There must be no people or animals near the vehicle due to the risk of collision and/or overturning!

Never allow other people to stand on or near the lift system during work due to the risk of crushing!

The vehicle and the machine must be operated from the driver's seat of the vehicle!

⚠ WARNING

Mounting and connection of the machine must only be carried out by professionals who have knowledge and understanding of hydraulic systems, in order to avoid pollution of the environment, leaks and contamination of the closed hydraulic system!

⚠ WARNING

Installation of Multi Carrier and attachment tools on a vehicle must take place on a level and safe surface!

Great care must always be taken when a Multi Carrier incl. attachment tool is mounted and connected to the vehicle!

5.4.3.1) Mounting and connecting the PUMA 3303 Multi Carrier to the vehicle

NOTICE

These instructions show and explain how the PUMA 3303 Multi Carrier is mounted on an approved front loader using suitable loader brackets with hydraulic quick couplings.

The instructions assume that the Multi Carrier has already been prepared correctly prior to mounting and connection.

MOUNTING AND CONNECTING: PUMA 3303 MULTI CARRIER

- 1. Place the PUMA 3303 Multi Carrier on its support feet, with a firm and stable surface underneath.**

(PICTURE)

Make sure to have good manoeuvring space around the machine:

- 2. Adjust and carefully steer the front loader of the vehicle into the hooks of the loader brackets on the PUMA 3303 Multi Carrier:**

Make sure that the hooks from the loader brackets have a firm grip on the front loader frame, and that the holes and locking pins are aligned before locking the front loader locking mechanism.

(PICTURE)

Table 20 – Mounting and connecting the PUMA 3303 Multi Carrier onto a vehicle (1/4)

- Carefully lift the front loader of the vehicle until the PUMA 3303 Multi Carrier slowly leaves the ground and fall into place with the locking mechanism of the front loader.

(PICTURE)

Activate the locking mechanism on the vehicle to secure the Multi Carrier onto the loader frame. The PUMA 3303 Multi Carrier is now mechanically mounted.

WARNING

The operator must always ensure that the Multi Carrier is fully locked into position on the front loader, before lifting it off the ground and before leaving the cab!

- 3x hydraulic hoses from the PUMA 3303 Multi Carrier are connected to the vehicle's oil outlets: **Pressure**, **return** and **drain**.

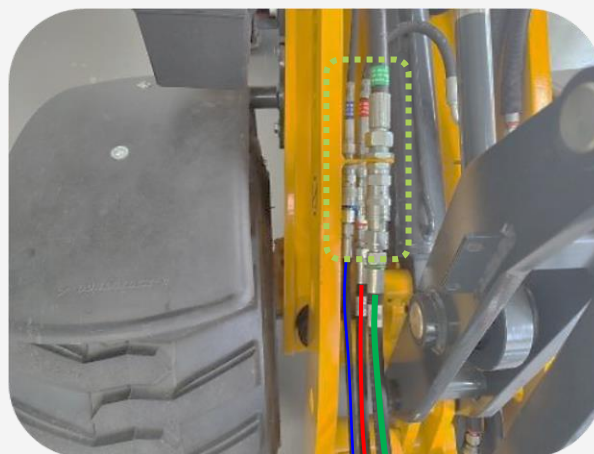

**DK : TRYK
UK: PRESSURE
D: DRÜCK**

The Multi Carrier must be supplied with minimum 50 l/min @ 180 bar (13.20 gpm @ 2610 psi) from the vehicle's hydraulic outlets.

**DK : RETUR
UK: RETURN
D: RÜCKLAUF**

The return back-pressure on the Multi Carrier must never exceed 15 bar! (217.56 psi). * (Greentec always recommends a 1/2" return line on the vehicle)

**DK : DRÆN
UK: DRAIN
D: LECK**

The drain connection on the Multi Carrier cannot have a back pressure of more than max. 2 bar (29 psi) and must never be connected to the return connection!

* The oil flow divider and hydraulic motor on the attachment tool needs a minimum return line pressure to ensure correct working conditions.

GreenTec's machines are designed to run within an open loop system, where the fluid cycles through, returning to the tank at the end of the cycle. There, it loses heat before being cycled through the system again.

Table 21 – Mounting and connecting the PUMA 3303 Multi Carrier onto a vehicle (2/4)

5. Hydraulic hoses for the **hydraulic cutting angle adjustment** (PUMA 3303 Standard only!) requires another separate oil outlet on the vehicle.

Make sure that the oil outlet is individually controllable from the vehicle's controls!

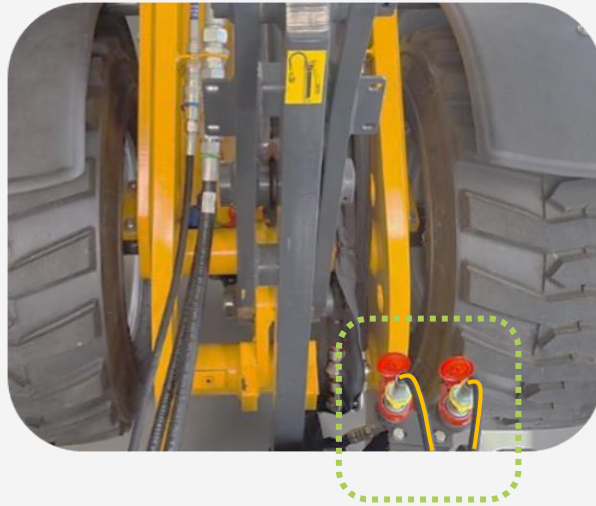

6. For PUMA 3303 Plus-models with e-control: a power cable from the transmitter/oil flow divider is connected with a 3-pin 12V connector, onto the vehicle's 12V-socket. *



* 12V-sockets on vehicles may vary between different manufacturers! Always refer to the user manual for the vehicle used when connecting the PUMA 3303 Multi Carrier with e-control!

Table 22 – Mounting and connecting the PUMA 3303 Multi Carrier onto a vehicle (3/4)

WARNING

The drain pressure must never exceed the return pressure on the machine! A higher back pressure than permitted on the drain connection causes damage to the oil motor and the warranty will be void! The drain connection must always be routed by itself as a pressureless tank connection and must never be connected to the return connection!

WARNING

Always remember to turn the locks on the hydraulic quick couplings to avoid accidental disconnection when a branch etc. sweeps over the quick couplings! If one of the hydraulic connections is broken loose during use, the oil motor will be damaged and the warranty for this will be void!

CAUTION

Before connecting the hydraulic quick couplings, the inserts must be carefully cleaned to avoid contamination and wear on the seals. Use suitable protective components such as plugs and caps when quick couplings are not in use to prevent unnecessary wear or damage. Impacts, such as falling to the ground,

can damage a hydraulic quick coupling. Take precautions to avoid this type of impact.

⚠ CAUTION

Hydraulic hoses must always be routed and installed so that they can move freely with the movements of the attachment tool and the Multi Carrier, without getting pinched, detached or otherwise damaging the machine or other equipment!

7. With the PUMA 3303 Multi Carrier fully mounted and connected onto the vehicle, prepare it for an approved attachment tool by removing the safety rivet and unfolding the swingarm of the machine to the side.

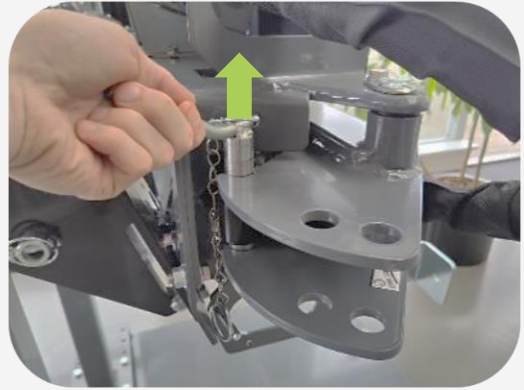

8. Use one of two different options, depending on the desired angle of the swing arm:

- 0° degrees (straight angle)
- 20° degrees (angled slightly forward) *



* It is recommended to use the 20°-degree angle when using the PUMA 3303 Multi Carrier with either RI-82 Barrier Mower and/or BR 70 Weed Clearing Brush. For any other approved attachment tool, the 0°-degree angle is recommended!

Table 23 – Mounting and connecting the PUMA 3303 Multi Carrier onto a vehicle (4/4)

5.4.3.2) Un-mounting and disconnecting the PUMA 3303 Multi Carrier from the vehicle:

Un-mounting and disconnecting the Multi Carrier is done in the reverse order, cf. section on [Mounting and connecting the PUMA 3303 Multi Carrier to the vehicle](#) – page 38-41.

⚠ WARNING

Un-mounting and disconnection of the Multi Carrier must take place on a flat and safe surface!

Great care must always be taken when un-mounting the Multi Carrier and disconnecting from the vehicle!

⚠ CAUTION

The attachment tool must always be un-mounted before the Multi Carrier is disconnected and removed from the vehicle!

When un-mounting and/or replacing machinery, always check the hydraulic system for residual pressure!

A possible residual pressure in the system is reduced to zero (**0 bar / 0 psi**) before disconnecting the hydraulic hoses!

When un-mounting the attachment tools, follow the instruction material for the attachment tool used!

NOTICE

The Multi Carrier and attachment tool can be advantageously placed on a transport pallet when un-mounting and disconnecting. The machinery can thus be moved around more easily.

5.4.3.3) Mounting and connecting attachment tools to the PUMA 3303 Multi Carrier

Mounting and connection instructions for attachment tools on the PUMA 3303 Multi Carrier will always differ between each individual attachment tool.

Common for all approved attachment tools are, that they are bolted onto the PUMA 3303 Multi Carrier's mounting bracket mechanically, and connected hydraulically with either standard or hydraulic quick couplings.

Drive the machinery out to a large area with firm ground, plenty of space and no people/animals in a minimum radius of at least 10 meters from the vehicle.

Start the up the PUMA 3303 Multi Carrier here, without starting the attachment tool, and follow all the procedures for initial start-up, use and stability in the following section: [Preparing the machine for use](#) – page 43-47.

NOTICE

Always refer to the individual attachment tool's user manual and instructions therein. User manuals and other technical documentation are always available on GreenTec's website: [Support – Product database](#)



Example of PUMA 3303 Multi Carrier mounted on a front-loader w/ LRS 2402 Quadsaw.

5.5) Preparing the machine for use

After complete mounting and connection of the attachment tool to the Multi Carrier/vehicle, the following procedures in this section are carried out before putting the machine into use:

5.5.1) Procedures before start-up and use

The operator of the machine must always have read and understood the user manuals, for both vehicle, Multi Carrier and the attachment tool in use!

Before start-up and use, be sure to have reviewed all points, instructions and procedures in the following sections of this user manual:

- [Safety](#) – page 6-15.
- [Instructions for using the machine \(k\)](#) – page 33-34.
- [Instructions for mounting, connecting, and disconnecting \(j\)](#) – page 35-42.
- [Stability \(o\)](#) – page 44-45.
- [Daily and routine inspections \(e\)](#) – page 64-65.

5.5.2) Training of machine operators before use

The GreenTec attachment tool may only be used mounted with Multi Carriers approved by GreenTec, and on an approved vehicle as a single unit.

The operator of a vehicle with a Multi Carrier and attachment tool mounted must therefore both review and understand the user manual for the attachment tool as well as the user manuals for the Multi Carrier and the vehicle used, before putting the machine into use.

The operator must be competent and fully capable of working with this machine in a safe and efficient manner before using it in a public place.



The instructions must be completely understood before attempting to mount, connect or use the machine.

If there is any doubt, contact the dealer or GreenTec's After-sales service!

GreenTec offers paid commissioning at the customer's place when purchasing a machine!

5.5.3) Stability (o)

When driving with the attachment tool, the operator must always be aware that the machine's centre of gravity shifts during work:

⚠ DANGER

After mounting and connection it must always be ensured that the complete vehicle is stable enough to be able to carry the Multi Carrier with the attachment tool attached.

Especially that the vehicle is stable enough sideways, also when the attachment tool is working at a greater height and hangs on the side of the vehicle, as well as when driving on an uneven surface and/or in a bend!

NOTICE

Depending on the weight and stability of the vehicle used with the Multi Carrier and attachment tool, it may be necessary to use front-side or rear weights to maintain stable rear axle pressure on the opposite wheels from which the attachment tool is mounted.

The suggestions below are only indicative in terms of stability and are not a direct instruction to strengthen the stability of the specific vehicle.

It is recommended that the dealer of the vehicle be contacted, for specific advice on increased stability, and/or for advice and guidance on tire pressure etc. for the vehicle on which you want to mount the Multi Carrier and attachment tool.

5.5.3.1) Checking the stability:

⚠ CAUTION

Carefully examine the stability of the vehicle/Multi Carrier with the attachment tool mounted!

Slowly operate the attachment tool all the way to the outer position using the Multi Carrier's arm system. Leave the attachment tool at a low height: Max. ½ meter (1.5 ft.) above the ground.

(The attachment tool **is not to be started** during this check!)

Perform the following procedures:

1. Ensure that the machine is in working position with the Multi Carrier arm system fully extended to the outer position. Let the attachment tool be max. ½ meter (1.5 ft.) above the ground.
2. Carefully move the vehicle with the Multi Carrier mounted, as well as move the working angle of the attachment tool around the entire range of movement: both horizontally and vertically.
 - a. Is the vehicle stable on all 4 wheels?
 - b. Are the lift arms stable?
3. Is the vehicle stable when turning and driving around - also on uneven terrain?

4. Assessment is made in each individual situation, and it is the full responsibility of the operator and operators to ensure that the vehicle does not overturn or tip over. If the vehicle and Multi Carrier are stable, the attachment tool can be moved up step-by-step.
5. If the operator judges that the vehicle and Multi Carrier are not stable, the vehicle must be stabilized. (Follow the user manual for the vehicle in use!)

5.5.3.2) Stability can be increased by:

- Mounting counterweights on the vehicle and/or Multi Carrier.
- Top up water in the vehicle's tyres. (Check with the tire manufacturer, and remember frost protection at temperatures close to or below freezing)
- Track width of the vehicle; the longer the wheels are out, the greater the stability. (To be examined at the vehicle dealer)
- Stabilizer on the front axle, especially on the attachment tool's side. (To be examined at the vehicle dealer)

⚠ DANGER

It is especially important that the operator has an understanding of the stability and that you must always drive according to the conditions!

Never use the Multi Carrier with attachment tools on an unstable or unsuitable vehicle.

5.5.3.3) Factors influencing stability:

- The centre of gravity of the machine combination and the height at which work is being done in combination with the weight hanging out on the side of the vehicle.
- Weight, counterweight, track width and vehicle wheelbase.
- Acceleration, braking, turning and the relative position of the attachment tool during these manoeuvres.
- The nature of the terrain: are you driving uphill, downhill or on a slope? What is the type of surface: soft, hard, or uneven?
- Pay special attention to the fact that articulated loaders shift the weight balance significantly more to the side, the sharper the turn.

5.5.4) Initial start-up and commissioning

The initial start-up of the machine for use, like the initial mounting and connection of the machine, should always be carried out by the dealer with the necessary knowledge and experience.

When the attachment tool is to be used for the first time with an approved Multi Carrier on the vehicle, it is recommended to always go through the steps below to ensure an optimal and safe first start-up of your machine:

PROCEDURES FOR INITIAL START-UP AND COMMISSIONING:	
1. Check the stability of the machinery:	Before the first start-up and commissioning, it must always be ensured that the complete vehicle is stable enough to be able to carry the Multi Carrier with the attachment tool attached. (See section: Checking the stability – page 44-45)
2. Check the bolts of the machinery:	Make sure that all bolt assemblies on the machinery are correctly tightened, especially bolts for the blades/knives and bolts at the adapter bracket for between the attachment tool and the Multi Carrier. (See section: Tightening of bolts – page 66)
3. Start the machinery for the first time by activating the oil supply from the Multi Carrier:	Let the machine run for approx. 5 minutes at idle with low RPMs, to warm up the hydraulic oil before use.
4. Inspect the hydraulic system for leaks:	Hydraulic hoses and fittings are inspected for possible leaks and are tightened. (See section: Tightening of hydraulic hoses- and fittings – page 67)
5. Check and prove the pressure specifications of the machinery:	Recommended pressure: 50 l/min @ 180 bar (13.20 gpm @ 2610 psi) Max. return backpressure: 15 bar (217.56 psi) for att. tools w/ external drain. 25 bar (362.59 psi) for att. tools w/o external drain. Max. allowed drain backpressure: 0-2 bar (0 – 29 psi) * (See section: Checking pressure- and flow specifications – page 70)

Table 24 – Procedures for initial start-up and commissioning

⚠ DANGER

*** Always check and prove the pressure specifications by measuring at each start-up!**

The driver of the vehicle must know how the oil should be handled
(Always see the safety data sheet for the hydraulic oil used!)

Oil splashes under high pressure from damaged fittings or hydraulic hoses can penetrate the skin and cause serious injuries!

⚠ WARNING

The drain pressure must never exceed the return pressure on the machine!

A higher back pressure than permitted on the drain connection results in serious damage to the oil motor and the warranty for this is void!

The drain connection must always be routed by itself as a pressureless tank connection and must never be connected to the return connection!

⚠ CAUTION

Always start up carefully when using for the first time and only drive in a private area until familiarity is achieved in using the machinery with the attachment tool mounted!

NOTICE

GreenTec recommends running the machinery at slow idle before use to warm up the hydraulic oil. It helps to protect the hydraulic components and significantly extend the life of both the motor and the pump!

5.6) Operation of the machine (e)

This section describes the handling of the machine, the operator's workplace when the machine is used, as well as operation and use of the machine.

5.6.1) Operator's workplace (f)

The attachment tool must always be mounted on an approved Multi Carrier using a vehicle and therefore the attachment tool is handled when operating from the vehicle.

⚠ WARNING

The operator must take breaks if this is deemed necessary and be aware of the strain from the working position.

⚠ CAUTION

Very much depending on how the Multi Carrier/attachment tool is positioned in relation to the operator, there may be stressful working positions.

It is important that the operator can follow and control the work of the equipment, while at the same time being aware of the course of the road, traffic conditions etc.

It is many things at once, and often with a twist on the back and/or neck. In the long term, this can put a strain on the body's musculoskeletal system, and it is therefore recommended to take appropriate breaks as needed during use.

NOTICE

Know and understand the operation of both the vehicle and the Multi Carrier, in order to control the attachment tool safely. The assembled machinery must be operated so that it is controlled in the most appropriate way, according to their instruction material.

The operator's workplace is always the vehicle's cab, where the Multi Carrier and attachment tool's control panels etc. are placed.

5.6.2) Transport of Multi Carrier and attachment tool on a vehicle (p)

When transporting the Multi Carrier, the most appropriate transport position depends both on the combination of Multi Carrier and attachment tool, but also on the vehicle used together with the Multi Carrier.

Since there are many combinations of Multi Carriers with different attachment tools mounted, as well as options for mounting additional equipment, it is important to find the best transport position for exactly your combination of machines.

The installation of various optional equipment can provide both opportunities and limitations for the positioning of the attachment tool during transport, and the vehicle design can also change the possibilities for the transport position of the attachment tool.

- Common to all transport positions for attachment tools on the PUMA 3303 Multi Carrier is that the construction on the swing arm ensures that the attachment tool will always point towards the vehicle, without being a danger or a nuisance to either the driver, pedestrians or other road users.
- Common to all transport positions for vehicles is that the positioning must not block either visibility or lights; both on the vehicle as well as on any light beam on any Multi Carrier.

⚠ DANGER

ALWAYS drive with ALL safety guards on, e.g., blades, when transporting all types of attachment tools.

Likewise, always try to turn attachment tools towards/along the vehicle and away from other traffic and pedestrians.

⚠ WARNING

When driving on public roads, it is always the operator's responsibility to always comply with applicable traffic laws and regulations! GreenTec cannot be held responsible for any violations of traffic laws and regulations while driving with tools carriers and/or attachment tools!

The attachment tool must not cover either the vehicle's or Multi Carrier's lights and/or the operator's view! Otherwise, additional lighting should be installed!



Example of transport position: Lights free on the vehicle, clear view, with safety devices mounted on the attachment tool, facing the vehicle for maximum traffic safety.

5.6.3) Start of attachment tool

The attachment tool can be started as soon as it is mounted correctly, and the Multi Carrier is in the working position. See sections: [Instructions for mounting, connection and disconnection \(j\)](#) – page 35-42 + [Preparing the machine for use](#) – page 43-47 + [Operation of the machine \(e\)](#) – page 48-61.

⚠ DANGER

Always make sure to check the immediate area around the machine and the vehicle before starting and during operation of the work the machine must perform. The size of the area depends on which attachment tool is used.

Always handle heavy machinery with care and caution, and always follow the regulations described in the attachment tool, Multi Carrier and vehicle user manual!

PUMA 3303 Standard (without e-control):

1. The attachment tool is started by activating the vehicle's hydraulic system/oil outlets at the lowest oil flow, so that the blades/knives on the attachment tool can rotate at low RPMs.

(Always refer to and follow the vehicle instructions used as these will vary from vehicle to vehicle!)

NOTICE

Always start with the attachment tool floating above the ground, and preferably in a place where there is room for extra movement, to find the appropriate oil supply.

2. Let the attachment tool run without load for 5-10 min., until the hydraulic oil in the system is heated.
3. When the hydraulic oil is at operating temperature, the optimum oil flow of minimum 50 l/min @ 180 bar (13.20 gpm @ 2610 psi) for the machine is found as follows:
 - a. With the attachment tool running at low oil flow/RPMs, the oil flow is slowly increased from the vehicle's hydraulic system/oil outlets.
 - b. Stop increasing the oil supply when the optimum oil flow of minimum 50 l/min @ 180 bar (13.20 gpm @ 2610 psi) is achieved, or until the Multi Carrier incl. the movements of the attachment tool are smooth and continuous. (Attempt to operate the hydraulic cutting angle at the same time as the attachment tool is activated!)
4. The correct oil flow from the vehicle ensures the most comfortable use of both the Multi Carrier and the functions of the attachment tool and minimizes vehicle fuel consumption and heat in the hydraulic system.

⚠ WARNING

The flow specifications (l/min @ bar or gpm @ psi) must always be kept within the regulations for Multi Carrier as well as attachment tool and must never be exceeded.

See section: [Specifications](#) – page 31 + [Mounting and connecting the machine \(i\)](#) – page 37-42.

PUMA 3303 Plus (with e-control):

The electronic functions on the Multi Carrier provide, using a receiver + wireless remote control, the possibility of adjusting both the cutting angle and the start/stop of the attachment tool.

1. The attachment tool is started by activating the vehicle's hydraulic system/oil outlets at the lowest oil flow, so that the blades/knives on the attachment tool can rotate at low RPMs.
(Always refer to and follow the vehicle instructions used as these will vary!)

NOTICE

Always start with the attachment tool floating above the ground, and preferably in a place where there is room for extra movement, to find the appropriate oil supply.



2. The emergency stop-button on the remote control is deactivated. The status LED is now flashing in blue.
(Wait until the LED lights solid blue. The remote control is now in standby mode!)

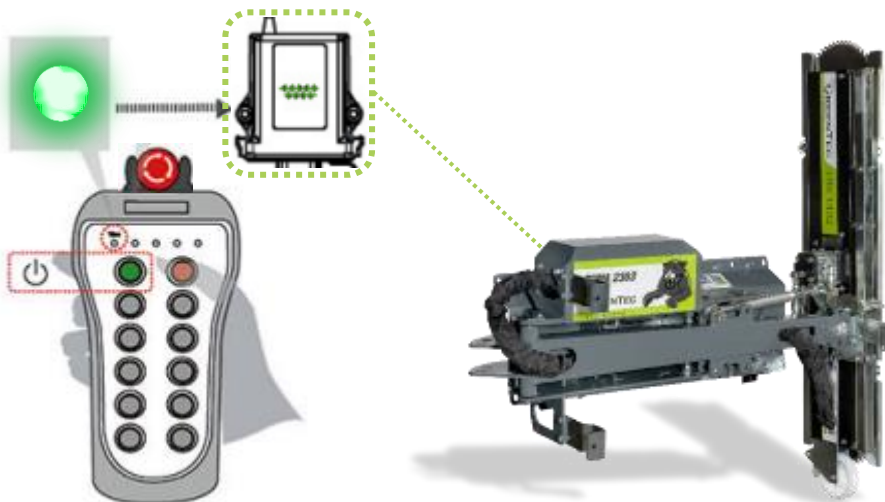

3. Press:  to connect the remote control to the receiver on the PUMA 3303 Multi Carrier.

(The status LED flashes green until the remote control is linked to the receiver. When the receiver confirms the connection, the status LED lights solid green, and the functions of the remote control can now be used with the PUMA 3303 Multi Carrier)



4. Press:  to start the attachment tool. Let the attachment tool run at idle without load for 5-10 minutes until the hydraulic oil in the system is heated.
5. When the hydraulic oil is at operating temperature, the optimum oil flow of minimum 50 l/min @ 180 bar (13.20 gpm @ 2610 psi) for the machine is found as follows:
 - a. With the attachment tool running at low oil flow/RPMs, the oil flow is slowly increased from the vehicle's hydraulic system/oil outlets.
 - b. Stop increasing the oil supply when the optimum oil flow of minimum 50 l/min @ 180 bar (13.20 gpm @ 2610 psi) is achieved or until the Multi Carrier incl. the movements of the attachment tool are smooth and continuous.
 - c. Attempt to operate the hydraulic cutting angle at the same time as the attachment tool activated using the buttons:   on the remote control to check that sufficient oil flow is achieved.
6. The correct oil flow from the vehicle ensures the most comfortable use of both the Multi Carrier and the functions of the attachment tool and minimizes fuel consumption and heat in the hydraulic system.

⚠ WARNING

The flow specifications (l/min @ bar or gpm @ psi) must always be kept within the regulations for Multi Carrier as well as attachment tool and must never be exceeded.

See section: [Specifications](#) – page 31 + [Mounting and connecting the machine \(i\)](#) – page 37-42.



5.6.4) Stop of attachment tool

The attachment tool must always be stopped at the lowest oil supply from the vehicle's hydraulic system/oil outlets:

PUMA 3303 Standard (without e-control):

1. The attachment tool is first stopped by reducing to a low oil flow / low RPMs on the vehicle!
(Always refer to and follow the vehicle instructions used as these will vary from vehicle to vehicle!)
2. The attachment tool comes to a complete stop as soon as the vehicle's oil supply to the Multi Carrier is turned off.
3. Always let the blades/knives of the attachment tool rotate until they stop!

PUMA 3303 Plus (with e-control):

1. The attachment tool is first stopped by reducing to a low oil flow / low RPMs on the vehicle!
(Always refer to and follow the vehicle instructions used as these will vary from vehicle to vehicle!)
2. The attachment tool is stopped completely by pressing:  on the remote control.
(Always let the blades/knives of the attachment tool rotate until they stop!)
3. The remote control can be completely switched off by pressing: 

⚠ DANGER

Many attachment tools have heavy blades/knives or rotors. Therefore, these will often rotate for up to 30 seconds after the hydraulic supply is cut off

Never go near attachment tools without making sure that the rotating parts have come to a complete stop!

5.6.5) Setting and adjusting the machine (r)

Setting and adjusting the machine always depends on the vehicle and/or Multi Carrier that is mounted together with the attachment tool. In general, both vehicle incl. Multi Carrier, is handled and adjusted so that the attachment tool that is mounted does the best possible job, in the safest way.

Common to all attachment tools is that they must be mounted on the Multi Carrier, connected and then moved from the transport position to the working position.

Handling of specific attachment tools is described in their instructions for use! Check the user manual for the attachment tool used!

CAUTION

Pay special attention to the hydraulic impact protection (AHS) / "Break-back"-function when the Multi Carrier is set and adjusted to its working position with the attachment tool attached! See section: [Driving instructions](#) – page 58-60.

The functions for setting and adjusting the PUMA 3303 Multi Carrier are described below:

5.6.5.1) Setting the Multi Carrier on a vehicle

SETTING THE MULTI CARRIER ON A VEHICLE:



The Multi Carrier leans backwards, and the arm cannot be swung out.



The Multi Carrier is vertically set! The arm is in perfect balance and can swing out and in manually.



The Multi Carrier will lean forward on the vehicle and the arm will drop out on its own. **(Dangerous!)**

Table 25 – Setting the Multi Carrier on a vehicle

5.6.5.2) Setting the working position of the swing arm

SETTING THE WORKING POSITION OF THE SWING ARM:

Folded position / transport position:

(Used during transport of the Multi Carrier incl. attachment tools)

Transport position:

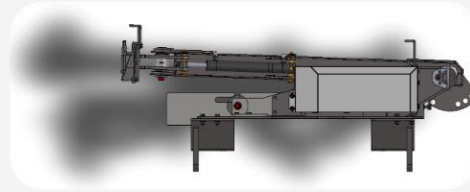

Standard working position for the Multi Carrier:

(All approved attachment tools can be used in this working position)

0° degree working angle:

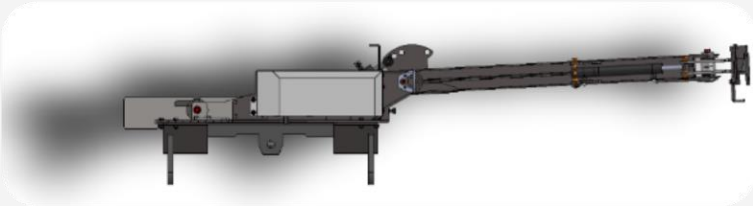

Working position for RI 62/82 Barrier Mower or BR 70 Weed Clearing Brush: *

20° degree working angle:

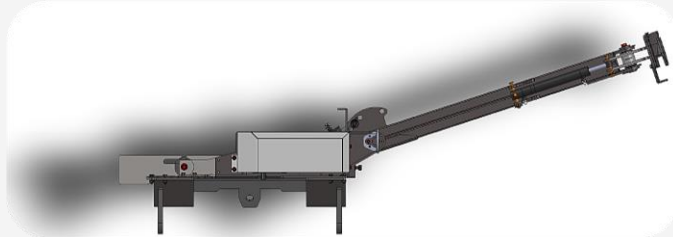

* The position gives a better look and overview of these machines and can also be advantageously used together with vehicles with 4-wheel steering ('crab walk') on e.g. narrow paths.

Table 26 – Setting the working position of the swing arm

5.6.5.3) Adjusting the cutting angle for the attachment tool

ADJUSTING THE CUTTING ANGLE FOR THE ATTACHMENT TOOL:

With hydraulic adjustment (optional equipment), a cylinder is used to adjust the cutting angle of the attachment tool. The cylinder is adjusted directly from the vehicle's hydraulic system from the driver's seat. *

Hydraulic adjustment: (PUMA 3303 Standard)



For electro-hydraulic adjustment (Plus models) an electrically controlled valve block incl. a cylinder is used for adjusting the cutting angle of the attachment tool. The cylinder is adjusted using the supplied remote control.

Electro-hydraulic adjustment: (PUMA 3303 Plus)



* The hydraulic cutting angle adjustment on the PUMA 3303 Standard requires an additional 1 x DA-outlet from the vehicle. From here, the angle of the attachment tool is adjusted directly from the vehicle's own hydraulic controls. Always refer to the user manual of the vehicle!

Table 27 – Adjusting the cutting angle for the attachment tool

5.6.5.4) Function of PUMA e-control

All Plus-models come with a wireless remote to control the different functions of the PUMA 3303 Multi Carrier.

The functions of the remote control on PUMA Plus Multi Carrier are described below:



5.6.6) Driving instructions

The machinery must always be operated and used in the most appropriate way, so that you achieve the best possible result and the greatest safety during use.

⚠ DANGER

The machinery must at all times be used within the limitations of the machine's safety instructions, intended use and area of application, so that it is always used for its intended purpose.

See sections: [Safety – page 6-15](#) + [Intended use of the machine \(g\) + Application and restrictions of the machine \(h\) – page 18](#).

⚠ DANGER

Under no circumstances should people or animals stay within the working area of the machinery during use!

NOTICE

Specific driving instructions cannot be described in this user manual alone. Always use the vehicle's mounted Multi Carrier incl. the attachment tool's instructional material for guidance on correct driving and use, in combination with the information given in this section.

The prescribed driving instructions with the machinery are based on the operator having understood both the operation and functions of the vehicle, the Multi Carrier and the attachment tool, as well as having carried out a complete implementation of all instructions in the section: [Preparing the machine for use](#) – page 43-47.

All the functions of both the vehicle, the operation of the Multi Carrier, and the functions of the attachment tool should be understood with the operator, as it is a combination of these that determines the result of the e.g., fence and hedge cutting.

1. The safety pin is removed from the swing arm. The swing arm on the PUMA 3303 Multi Carrier is rotated from the transport position to full working width with the attachment tool mounted.



2. The safety pin is mounted again between the swing arm and impact cylinder, in one of the 2 settings: 0° or 20° working angle.



3. Apply the correct oil flow from the vehicle's oil outlets and activate the Multi Carrier using its controls.

(PICTURE)

4. Maneuver the vehicle, adjust the working height and use the Multi Carrier's operation and/or functions to control and position the swing arm with the attachment tool to the position that is most appropriate for the work to be performed. *



* Use the vehicle's and attachment tool's operating instructions for correct setting and positioning.

Table 28 – Driving instructions: PUMA 3303 Multi Carrier (1/2)

5. The working angle of the attachment tool must be adjusted to the best possible position using either the vehicle's controls (PUMA Standard), or remote control of the Multi Carrier. (PUMA Plus) *
Adjust the attachment tool so that it is driven parallel to the vehicle in the direction of travel.



6. The direction of travel with attachment tools must take place in a forward direction and must follow the contours of the ground and/or the line of the "fence". The hydraulic impact protection (AHS) is only activated in the forward direction, and acts as a mechanical pre-pressure on the blades/knives of the attachment tool against the material being processed. If there is a major difference in the material and/or the contours of the ground, the cutting height and/or distance on the machine is corrected so that the material meets the blades/knives straight on.



7. The forward speed when using the attachment tool must be max. 5-7 km/h (3-4mph) but must always be adjusted so that the cutting result is optimal.

It is here that the individual attachment tool and the conditions under which the work is done determine what speed should be driven at!



* Use the attachment tool's user manual for correct setting and positioning.

Tabel 29 – Driving instructions: PUMA 3303 Multi Carrier (2/2)

⚠ DANGER

If blades/knives are blocked on the attachment tool: Stop the machine, stop the vehicle, remove the ignition key, apply the parking brake and use safety glasses and gloves before attempting to remove material/unwanted objects from the blades/knives.

See section: [Start-up after unintended / accidental stoppage \(q\)](#) – page 61.

5.6.7) Start-up after unintended / accidental stoppage (q)

NOTICE

In case of accidental stoppage of attachment tool and/or Multi Carrier, always follow the instructions given in the machines' user manuals.

See section: [Safety instructions for maintenance, adjustment, and inspection \(s\)](#) – page 15.

An unintended stoppage of operation can occur at any time. There can be various reasons, but often downtime can be avoided if the operator uses and maintains the machine correctly and avoids hitting:



- Bigger rocks
- Tree stumps
- Fence wire
- Manhole covers
- Litter
- Plastic and/or other packaging
- Bicycles/scrap

If the attachment tool hits any of the above objects, strong vibrations and/or increased noise will typically occur.

In the event of signs of strong vibration/noise in connection with the above, or in the event of e.g. leakage, lost and/or loose parts on the machine, the operator should do the following:

1. Stop the machinery immediately.
2. Tilt the attachment tool around and lower to a low height so that the machine's elements can be inspected.
3. **Pull the handbrake, switch off the vehicle, take out the key and make sure that the machinery has come to a complete stop!**
4. Attachment tools and Multi Carrier are inspected and checked:
 1. If foreign bodies are found, these are released manually. (Fence wire, plastic etc.)
 2. Check machine parts for cracks, breaks, missing parts, or any other damage.
 3. Do not continue driving until all damage has been repaired.

Follow the recommendations below for starting the machinery after a shutdown:

- Follow the recommendations below for starting up after a shutdown:
- Restart the attachment tool slowly. (See the user manual for attachment tool in-use + section in this user manual: [Start of attachment tool](#) – page 50-52.
- Pay particular attention that both the attachment tool and the Multi Carrier work according to all guidelines stated in their user manuals.



6) Inspection and maintenance (e, r)

To ensure a long working life of the machine, good and careful inspection and maintenance is required.

Remember that the machine is designed to withstand the harshest conditions, and that with a little care and attention it will be able to give you many years of trouble-free operation.

To avoid problems and ensure that the warranty covers, always use original [GreenTec spare parts](#) and make sure that the machine is not used for anything other than described in this user manual.

The owner or operator must ensure that the machine is only used, maintained, inspected, and repaired by persons who are familiar with the procedures associated with it and are instructed in the associated dangers.

If doubts arise in connection with some of the procedures mentioned, contact an authorized specialist workshop or importer/retailer (See: www.greentec.eu)

Repair work that is not described in the user manual may only be carried out by authorized specialist workshops.



IGNORING ONE OR MORE OF THE SAFETY INSTRUCTIONS MAY MEAN:

⚠ DANGER

Great danger to people due to mechanical and chemical influences!

⚠ WARNING

Danger to the environment due to leakage of hydraulic oil! Damage and defects to the attachment tool, Multi Carrier or the towing vehicle!

NOTICE

The warranty on the machine is void if one or more of the safety instructions are disregarded.

GreenTec is not liable for compensation claims for damages caused by incorrect use of the machine and incorrect connection or connected equipment, or by incorrect maintenance of the machine!

6.1) Instructions for safe maintenance and adjustment (s)

To avoid accidents during maintenance and adjustment, the following points must always be observed:

DANGER

All work on the machine must only be done when the machine is stopped, the vehicle is switched off, the handbrake is applied, and the key is removed from the ignition lock on the vehicle!

During maintenance work on lifted attachment tool, securing with suitable support elements must be carried out!

Only use suitable tools and use the prescribed personal protective equipment prescribed in this user manual!

Great care should be taken when working with the machines, as there is a danger of fingers and hands being trapped by e.g. drive belts, pulleys, blade blades, rotors, guards etc.!

WARNING

Immediately after finishing maintenance work, all safety and protective devices etc. mounted and activated again! During maintenance, you can often come into contact with hydraulic oil, gearbox oil and grease. Always avoid skin contact, inhalation, etc.!

Always use the correct protective equipment and use the safety data sheets for these!

ALWAYS dispose of oil and grease in a regulatory and environmentally sound manner!

6.1.1) Properly move your GreenTec machine

GreenTec recommends moving machines and attachment tools around on their supplied support devices/stands, or transport pallets (EU standard) if support devices are not available.

If machines are to be moved, always use a forklift or pallet lifter. Always check the weight of your GreenTec machine under the machine specifications.

Materials and components used in connection with moving the machine must be approved for *more than the stated weight of the machine*.

DANGER

There is a risk of crushing as the machine can turn/overturn during transport.

There must not be people on both sides of the machine during lifting, or in the area where the machine can tilt.

Never try to lift or move the Multi Carrier with the attachment tool attached! Attachment tools and Multi Carriers are moved separately from time to time as long as they are not mounted on a vehicle!

6.2) Daily and routine inspections (e)

⚠ CAUTION

Before starting up a new machine, a daily inspection is carried out before starting up, and again already after **3-5 operating hours**. After this, a daily inspection after using the machine is sufficient, combined with a six-monthly inspection of the machine! (Every 6 months)

At the beginning of the machine's service life, extra attention should be paid to the tightening of bolts, shielding and any belt tension on attachment tools.

NOTICE

Always remember to check the entire machinery, both vehicle, Multi Carrier and the attachment tool used.

It is important that the operator knows the machines and carries out the daily and routine inspections necessary for the vehicle, the Multi Carrier and the attachment tools used.

For correct inspection and maintenance, the user manuals for the respective machines must be used at all times. (Vehicle, Multi Carrier and attachment tool)
Always be safe in the daily routines and inspection of machines!

Daily inspection is always carried out after the first 3-5 operating hours. All points MUST be reviewed!
Thereafter, a daily inspection is carried out each time the machine is used:

DAILY INSPECTION OF THE MACHINE:

1. General overall impression of the machine:	Possible damage and/or errors must be corrected immediately.
2. Intact guards/shielding, incl. rubber flaps on attachment tools + belt housing:	All forms of guards/shielding must be intact.
3. Cracks in the frame's sides, corners and around the mounting points:	Also look for dents and/or bent parts.
4. Loose parts or missing bolts:	Retighten all bolts! (See section: Tightening of bolts – page 66)
5. Inspect the hydraulic system for leaks:	Check all hydraulic hoses incl. fittings + motor, flow divider etc. (See section: Tightening of hydraulic hoses- and fittings – page 67)
6. Check hydraulic hoses and hose protection for correct guidance:	Check for wear marks and/or displaced hose protection. (See section: Hydraulic hoses – page 68)
7. Lubrication of the entire machine:	Best done after finished work, as the components on the machine are hot here and possible water/moisture is thereby pressed out of e.g. bearings, bushings etc. (See section: Lubrication of the machine – page 73)

Table 30 – Checklist for daily inspections: Before and after commissioning

Semi-annual inspection is always carried out after every 6 months. All points MUST be reviewed!
Thereafter, a daily inspection is carried out each time the machine is used:

SEMI-ANNUAL INSPECTION OF THE MACHINE:	
1. General review of machinery:	Do a careful daily inspection. Cleaning and maintenance/lubrication so that general maintenance is minimized. (See Table 30 – page 64)
2. Clean the entire machine of loose branches and dirt:	Wash and then lubricate the machine with anti-corrosion oil/grease where this is relevant. Especially on worn areas/parts of the machine! (See section: Cleaning/washing the machine – page 72)
3. Carefully check the condition of all hydraulic hoses:	Be aware that hoses do not rub against edges, flanges, bolts and the like. Hose protections are correctly fitted so that the hoses are always protected as best as possible. (See section: Hydraulic hoses – page 68)
4. Examine all bearings, and possibly shafts, rivets and bushings on the machine:	See section: Bearings, shafts, rivets, and bushings – page 69)
5. Store the machine well protected and dry:	Protect especially the hydraulic couplings on the attachment tool and Multi Carrier, and possibly bearings on work equipment against continuous rain, moisture, and temperature fluctuations. (See section: Storage of the machine – page 75)

Table 31 – Checklist for semi-annual inspection: preventive maintenance

6.3) Tightening of bolts and hydraulic connections

6.3.1) Tightening of bolts

All bolts and nuts on the machine are provided with quality class marking. Ordinary machine steel bolts have quality class 8.8: bolts marked with 8.8, and nuts marked with 8.

Hardened steel bolts may be marked 10.9 or 12.9: bolts marked 10.9 or 12.9, and nuts marked 10 or 12.

Individual bolts and nuts have no markings: these are always ordinary steel bolts and/or nuts in quality class 8.8 / 8.

Below are the nominal mounting torques for steel bolts/set screws (ISO 4014/ISO 4017 standard), within the



Bolts / steel set screws

TIGHTENING OF BOLTS:

				Regular steel bolts/set screws (Strength class 8.8) *	Hardened steel bolts/set screws (Strength class 10.9) *	Hardened steel bolts/set screws (Strength class 12.9) *
M6	1,00	10		9,8 Nm (7.23 lbf·ft)	14,0 Nm (10.33 lbf·ft)	17,0 Nm (12.54 lbf·ft)
M8	1,25	13		24,0 Nm (17.70 lbf·ft)	33,0 Nm (24.34 lbf·ft)	40,0 Nm (29.50 lbf·ft)
M10	1,50	16		47,0 Nm (34.67 lbf·ft)	65,0 Nm (47.94 lbf·ft)	79,0 Nm (58.27 lbf·ft)
M12	1,75	18		81,0 Nm (59.74 lbf·ft)	114,0 Nm (84.08 lbf·ft)	136,0 Nm (100.30 lbf·ft)
M14	2,00	21		128,0 Nm (94.40 lbf·ft)	181,0 Nm (133.50 lbf·ft)	217,0 Nm (160.05 lbf·ft)
M16	2,00	24		197,0 Nm (145.30 lbf·ft)	277,0 Nm (204.30 lbf·ft)	333,0 Nm (245.60 lbf·ft)
M18	2,50	27		275,0 Nm (202.83 lbf·ft)	386,0 Nm (284.70 lbf·ft)	463,0 Nm (341.50 lbf·ft)
M20	2,50	30		385,0 Nm (283.96 lbf·ft)	541,0 Nm (399.00 lbf·ft)	649,0 Nm (478.70 lbf·ft)
M22	2,50	34		518,0 Nm (382.06 lbf·ft)	728,0 Nm (536.90 lbf·ft)	874,0 Nm (644.60 lbf·ft)
M24	3,00	36		635,0 Nm (468.35 lbf·ft)	935,0 Nm (689.60 lbf·ft)	1120,0 Nm (826.00 lbf·ft)

* Indicative values: Bolts and steel set screws ($\pm 5\%$)

Table 32 – Tightening torques for bolts

6.3.2) Tightening of hydraulic hoses- and fittings

The hydraulic hoses and fittings used are all produced with metric threads.

Hydraulic connections are available in 2 series:

- Light-series (L): Used on hydraulic connections where the pressure does not exceed 250 bar.
- Heavy-series (S): Used on hydraulic connections where the pressure exceeds 250 bar, and up to 320 bar.

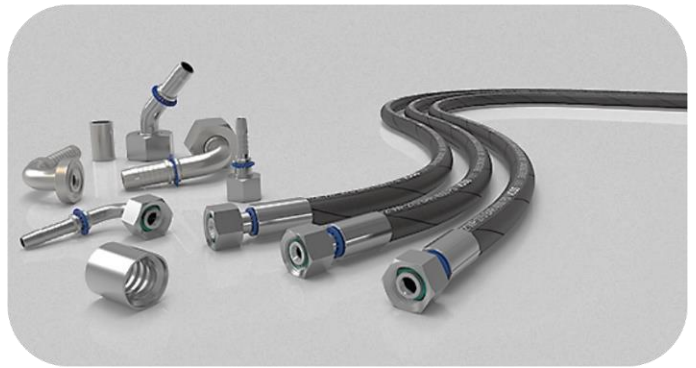

Hydraulic hoses and fittings

TENSIONING OF HYDRAULIC HOSES AND FITTINGS:

Size:	Series:	Tightening torque (Nm): *
M12	L 6	20,0 Nm (14.75 lbf·ft)
M14	L 8	30,0 Nm (22.13 lbf·ft)
M16	L 10	40,0 Nm (29.50 lbf·ft)
M18	L 12	50,0 Nm (36.88 lbf·ft)
M22	L 15	70,0 Nm (51.63 lbf·ft)
M26	L 18	90,0 Nm (66.38 lbf·ft)
M30	L 22	120,0 Nm (88.50 lbf·ft)
M36	L 28	160,0 Nm (118.00 lbf·ft)
M14	S 6	25,0 Nm (18.44 lbf·ft)
M16	S 8	40,0 Nm (29.50 lbf·ft)
M18	S 10	50,0 Nm (36.88 lbf·ft)
M20	S 12	60,0 Nm (44.25 lbf·ft)
M24	S 16	85,0 Nm (62.69 lbf·ft)
M30	S 20	140,0 Nm (103.26 lbf·ft)
M36	S 25	190,0 Nm (140.14 lbf·ft)

* Indicative values: Hydraulic connections ($\pm 5\%$)

Table 33 – Tightening torques for hydraulic hoses and fittings

6.4) Hydraulic hoses

⚠ WARNING

When inspecting hydraulic hoses, any damage/defect must be rectified immediately. When searching for leaks, due to the danger, suitable aids must be used: protective glasses, work gloves + a piece of cardboard that quickly reveals a leak! Thin jets of hydraulic oil under high pressure can penetrate the skin and cause serious injuries! In the event of injuries of this nature, seek immediate medical attention: **DANGER OF INFECTION!**

Check the condition of all hoses at regular inspections. Pay particular attention that they do not rub against edges, flanges, bolts etc., and that the stocking is correctly fitted, so that the hoses are always protected as best as possible.

Check all hydraulic hoses and fittings daily. Any damage or leakage must be repaired immediately. Hoses with damage/defects must be replaced.

GreenTec's hydraulic systems work at a very high pressure: from approx. 200 bar up to 320 bar (2900 – 4641 psi) Use only original hoses. A burst hose can be very dangerous!

When replacing hydraulic hoses, avoid twisting hoses and fittings.

- Use 2 spanners to loosen and tighten the hoses!
- Avoid over-tightening! (Correct tightening torques are given in the [Table 33](#) – page 67)
- If fittings or screw connections continue to leak, these must be replaced!

⚠ WARNING

A flexible hose must not be twisted during installation, as this will significantly reduce the life of the hose and may cause the connections to loosen. To determine if a hose is twisted or not, the specification line running the length of the hose must be straight. **If the specification line spirals around the hose, the hose is twisted:**



⚠ WARNING

A flexible hose must never be stretched tightly between two fittings. Approx. 5 to 8 percent of the total length should be allowed as slack to allow free movement under pressure. Under pressure, a flexible hose is compressed in length and expands in diameter.

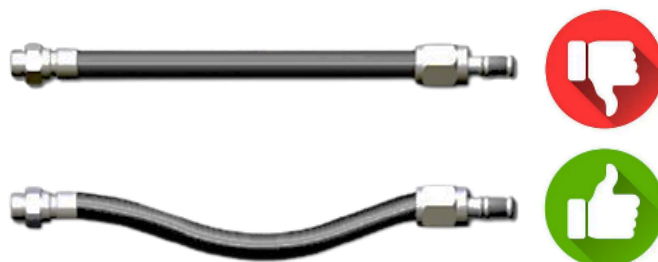

NOTICE

The warranty of the hydraulic hoses is limited to the replacement of hoses due to defective material or manufacturing. The warranty for hydraulic hoses is void if:

- Hoses are damaged due to wear and tear.
- If the hoses have been cut or pinched during work.
- If threads etc. are damaged due to over-tightening.

6.5) Bearings, shafts, pins, and bushings

All pivot points on GreenTec's PUMA 3303 Multi Carriers are equipped with replaceable bushings and pins.

If these show signs of wear, they must be replaced. All bushings, rivets etc. can be delivered from GreenTec's spare parts warehouse.

The correct spare parts for your GreenTec machine can always be found in the machine's spare parts book, which can always be downloaded and/or printed for personal use on our website: <https://greentec.eu/support/>

6.6) Checking pressure- and flow specifications

During service and maintenance of the machine, there may be a need to check, diagnose or verify the pressure and or flow specifications of the attachment tool. The total pressure of the machine is measured using manometers and/or flow meters.

There is a large selection of pressure gauges, flow meters, test couplings and other digital equipment for measuring and testing hydraulic systems. When choosing the right equipment, it is important to have details in place about: connection, thread size, accuracy, and compatibility.

- **Manometer** – A manometer is a measuring instrument for measuring the physical pressure (bar/psi) with which the hydraulic oil in the system is delivered.
- **Flowmeter** – A flow meter is a measuring instrument for measuring the flow rate (l/min/gpm) with which the hydraulic oil is delivered.
- **Test coupling** – A test coupling/test nipple makes it easy and safe to connect analog or digital measuring instruments to the system to make pressure and flow measurements.

6.6.1) Correct measurement of pressure and flow

The table below shows which pressure and flow specifications the PUMA 3303 Multi Carrier must work with. See section: [Specifications](#) – page 31.

NOTICE

If there is a need to measure pressure and/or flow between the vehicle and Multi Carrier, it is recommended to fit a test coupling for measurement. Measurement of pressure and flow should always be carried out at the flanges of the hydraulic flowdivider, in order to achieve the most correct measurement.

CAUTION

To keep test couplings as clean as possible while they are not in use, it is recommended to use a rubber cap to put over the nipple so that dust/dirt does not enter the coupling when it is not connected to measurement and test equipment.

MEASUREMENT OF PRESSURE AND FLOW: PUMA 3303 MULTI CARRIER

P-hose (Pressure): 1/2" – L15 (M22 x 1,5)	Min. 50 l/min @ 180 bar (13.20 gpm @ 2610 psi) *
T-hose (Tank/Return): 3/4" – L18 (M26 x 1,5)	Max. 15 bar (217.56 psi) for att. tools w/ external drain. Max. 25 bar (362.59 psi) for att. tools w/o external drain.
D-hose (Drain): 3/8" – L12 (M18 x 1,5)	Max. 0-2 bar (0-29 psi)

Placement of test coupling/test nipple:

When pressure and/or flow is measured on the Multi Carrier, it is measured just in front of the machine's oil flow divider.

That is between connection of flanges and hydraulic hoses:  (This applies to all 3 hydraulic hoses: Pressure, Return, and Drain.

Start-up Multi Carrier and attachment tool under normal operating conditions, and then operate the various functions of the machine.

Simultaneously do read-outs on the manometer during use!

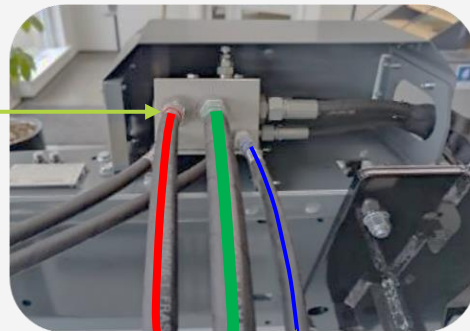

Table 34 – Measurement of pressure and flow: PUMA 3303 Multi Carrier

6.6.2) Re-filling the accumulator

⚠ WARNING

Only authorized personnel may carry out service work on the machine and the AHS system! The use of filler other than Nitrogen (air, oxygen, compressed air, gas etc.) are strictly prohibited as this will destroy the accumulator.

NOTICE

Contact GreenTec's After-sales service department.

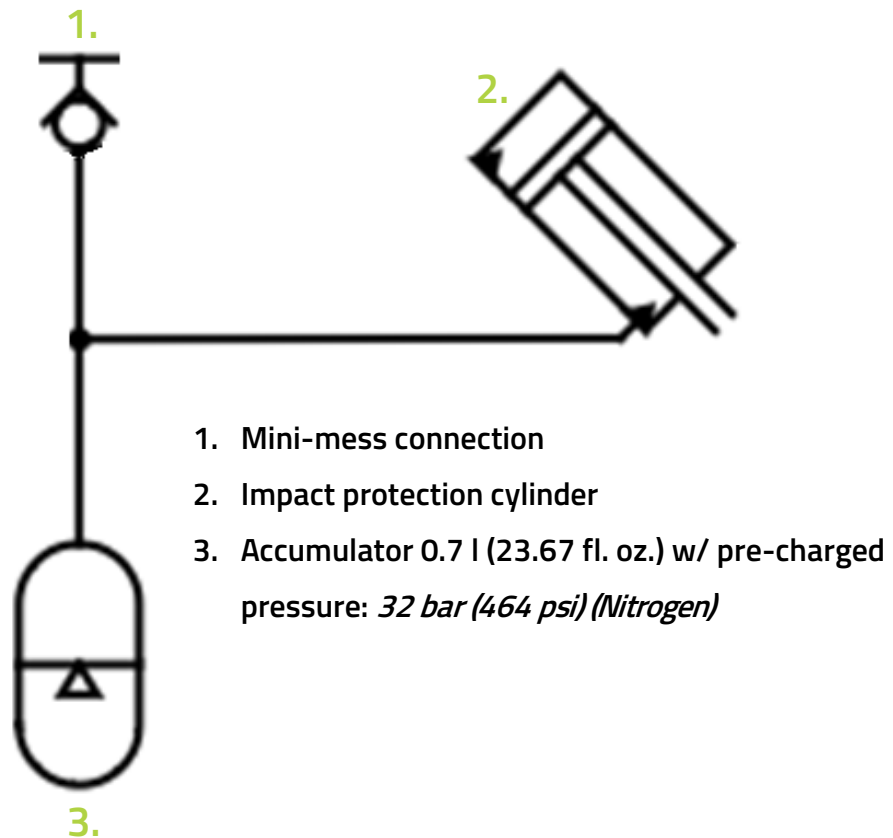

Warning!

Closed hydraulic circuit under high pressure. Stated value: 50 bar (725 psi) .

The impact protection cylinder is under constant pressure from the accumulator.

Any separation without draining the pressure will result in violent splashes, oil vapors and oil mist that can be very dangerous by inhalation and skin contact.

May only be disassembled by a qualified mechanic after the pressure has been drained from the system!

6.7) Cleaning/washing the machine

CAUTION

Be careful when using high-pressure cleaner close to the paint!

Steam cleaners are used with great care around the machine's labels/stickers!

Avoid harsh cleaning agents to avoid discoloration or damage to the paint!

It is important to store the machine covered so that it is protected from rain and sunlight. It must be placed on a flat surface or pallet!

Make sure that when storing the machine, there is no risk of it tipping over or falling down. Make sure for a suitable storage location or support of the machine!

Lubricate the machine with anti-corrosion oil afterwards, especially on the worn parts, also on the blades, rotors and internal shields of the attachment tool. This minimizes the formation of rust and prolongs the shelf life significantly!

See section: [Lubrication of the machine](#) – page 73.

6.8) Lubrication of the machine

There are a total of 2 lubrication points on the PUMA 3303 Multi Carrier. These are found on the swingarm and are marked with the following mark:

- The number in the dial (50) indicates that lubrication must be done after every 50 hours of work. (Approximately weekly)
- When lubricating, some pressure is given from an ordinary hand-held grease gun/press.

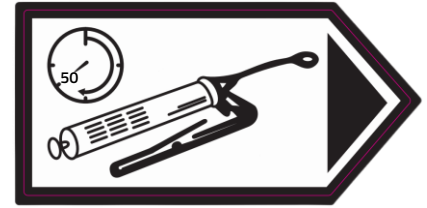

Mærke for smørenippel: 50 timers interval

CAUTION

Always stop when significant resistance is felt or when grease comes from the grease nipple.

GreenTec recommends using a manual grease gun to lubricate the machine! Grease guns with compressed air and the like can damage seals etc.!

NOTICE

GreenTec recommends lubricating both the Multi Carrier and the attachment tool after each work cycle, as the lubrication points that have been most heavily loaded are still hot and possibly dirt, acid, moisture, water and grass are pushed out immediately.

Below, the location of the 2 lubrication spots on the PUMA 3303 Multi Carrier is marked:



Location of the grease nipple at the inner side of the PUMA 3303 Multi Carrier swing arm

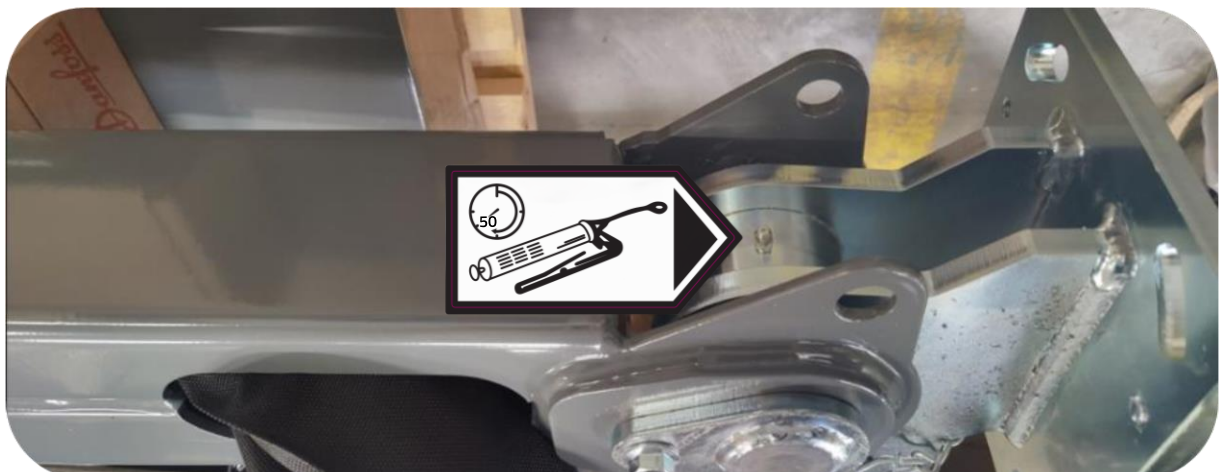

Location of the grease nipple at the outer side of the PUMA 3303 Multi Carrier swing arm

6.8.2) Worn / blank metal parts

It is an advantage after cleaning the machine to coat the blades/knives with any brand of anti-corrosion oil, so that the raw metal is protected against rust build-up and the service life is extended.

Lubricate the machine with anti-corrosion oil afterwards, especially on the worn and blank parts, but also on the blades/knives, rotors, and internal shields of the attachment tool. This minimizes the formation of rust and prolongs the shelf life significantly!

Lubrication will also help the blades/knives to make a cleaner cut.

With each lubrication with anti-corrosion oil, this is polished into the surface with a paper towel or similar.

DANGER

Anti-corrosion oils are dangerous on the skin and by inhalation! Know and use all safety regulations when using the oil!

6.9) Storage of the machine

Always store the machine so that it is protected from moisture, wind, and weather. Before putting the machine away for storage, it must be washed and dried carefully. Also remove all traces of leaves / branches and dirt.

⚠ CAUTION

GreenTec's machines **MUST** be stored dry, due to the risk of water in bearings, bushings and possibly electrical parts.

⚠ CAUTION

Do not leave hydraulic hoses lying on the floor. They pose a tripping risk and there is a chance of contamination of hydraulic interconnections!

Always lay all hoses over the machine/tool!

⚠ CAUTION

Always store attachment tools in a cleaned and dried condition! Dirt attracts moisture and will thus result in increased rust formation!

Damage to the paint must be repaired immediately!

6.10) Disposal of machine/machine parts

NOTICE

To ensure the most environmentally sound disposal method, the machine/machine parts must be disassembled, and the disassembled parts sorted into the following categories below:

DISPOSAL OF MACHINE PARTS:

Rubber and plastic parts	Belts, rubber curtains, support wheels, plastic components, etc.
Technical components	Motors, valve blocks, hydraulic hoses, etc.
Iron and Metal	Plates, profile pipes, tubes, bearing housings, blades, knives, pulleys, etc.
Chemistry	Hydraulic oil, grease etc.

Table 35 – Overview of the disposal/scraping of machine parts

7) Troubleshooting the machine

7.1) Troubleshooting procedures

If the PUMA 3303 Multi Carrier does not work correctly, the source of the error must be located on the machine. Faulty conditions on the machinery can be isolated by examining the following:

1. Where on the machinery is there an error / faulty condition?

(Errors can occur on the **Multi Carrier**, on the **attachment tool**, and/or on the **vehicle** used)

NOTICE

When troubleshooting the attachment tool and/or vehicle, refer to the user manuals for these.

2. What type of error /faulty condition?

- Is the error / failure **mechanical**? (Error on the mechanical parts)
- Is the error / failure **hydraulic**? (Error on the hydraulic parts)
- Is the error / failure **electrical**? (Error on the Multi Carrier and/or the vehicle's electrical system)

TROUBLESHOOTING INDEX: PUMA 3303 MULTI CARRIER

PROBLEM:	CAUSE:	SOLUTION:
Valves or hoses leaking	Hoses and/or fittings are loose.	Inspect and tighten hoses and hose fittings.
Hydraulic impact protection (AHS)	Triggers too easily.	Auth. dealer or workshop check AHS system, exhaust pressure (nitrogen) and oil pressure.
	Does not trigger.	Auth. dealer or workshop check AHS system, exhaust pressure (nitrogen) and oil pressure.
Cutting angle adjustment moves too slow when attachment tool is running	Oil flow too low from vehicle.	Increase oil flow to the Multi Carrier.
Overheating of machinery	Oil flow too high.	Check and reduce oil flow to specified max. flow for attachment tool (l/min.)
	Clogged radiator/cooler. (Vehicle)	Cooler is cleaned and checked. Remove leaves, dirt and debris here.
	Hydraulic system overloaded. (Vehicle)	Capacity on vehicle or reduced performance on attachment tool/forward speed
	Oil type incorrect. (Vehicle)	Check and change oil type.

(Continued) →

Hydraulic system fails	Oil level too low. (Vehicle)	Fill the vehicle with oil to the correct level. (Vehicle)
	Pressure hose pinched/bent.	Check all hydraulic hoses for pinching and damage.
	Oil leak in hydraulic system.	Check the hydraulic system for leaks. Possibly re-tension or repair of hoses and fittings.
	Oil pump suction filter stopped. (Vehicle)	Replace filter insert. (Vehicle)
Electrical switches fail	Defective wiring harness.	Check wiring and switches.
	Dirt in valve.	Checked by an authorized workshop.
	Valve is stuck.	Checked by an authorized workshop.
	Insufficient voltage.	Check for poor battery connection. Check the fuse (10A) in the power plug.
Remote control does not work (Plus models only)	No connection to the PUMA 3303 Multi Carrier	Follow the instructions for connection and operation. See section: Operation of the machine (e) – page 48-57
	Error code on remote control (LED)s	Follow troubleshooting guide: https://assets.danfoss.com/documents/56502/BC293071_182708en-000101.pdf

Table 36 – Identifying error / faulty conditions

8) Appendix

8.1) Hydraulic diagrams

NOTICE

Contact GreenTec's After-sales service department.

8.2) Electrical diagrams

NOTICE

Contact GreenTec's After-sales service department.

NOTES:

A series of horizontal dashed lines for writing notes, starting from the 'NOTES:' label and extending across the page.



A series of horizontal dashed lines spanning the width of the page, providing a guide for handwriting practice. The lines are evenly spaced and extend across most of the page's width.



The original content of this user manual cannot be re-produced, distributed, transmitted, transcribed, or translated without the prior written permission from GreenTec.

Copyright © 2024 GreenTec A/S
All rights reserved.

 **Made in Denmark**
Designed and manufactured

