

# Hydraulic attachment tools

Demolition, waste management and earth-moving.



# Product overview

Meet our hydraulic attachment tools. Built with technology that makes them light, compact and more powerful than ever.



**SB**  
55–1,060 kg



**MB**  
750–1,650 kg



**HB**  
2,000–10,000 kg



## Hydraulic Breakers

pages 8–13



**VC**  
1,400–3,200 kg



**ER & ERC**  
110–7,000 kg



**Options for ER & ERC – e.g.**  
Water spraying system



Cutting Wheels



**ER-L**  
250–1,800 kg



## Drum Cutters

pages 14–25



Demolition



Earth-moving



Recycling



**ADU**  
280–1,900 kg



**LPHB-M**  
31 kg



## Auger Drive Units

pages 26–27



HC  
160–1,400 kg



## Hydraulic Compactors

pages 28–29



CB  
320–7,400 kg



## Concrete Busters

pages 30–31



CC  
1,550–7,100 kg



## Combi Cutters

pages 32–33



DP  
1,820–2,990 kg



## Demolition Pulverizers

pages 34–35



BP  
1,770–4,550 kg



## Bulk Pulverizers

pages 36–37



MG  
90–5,700 kg



## Multi Grapples

pages 38–39



SC  
380–9,060 kg



## Steel Cutters

pages 40–41



HM  
1,550–2,000 kg



## Hydro Magnets

pages 42–43



BC  
2,250–6,050 kg



## Bucket Crushers

pages 44–45



BS  
1,710–2,450 kg



## Bucket Screener

pages 46–47

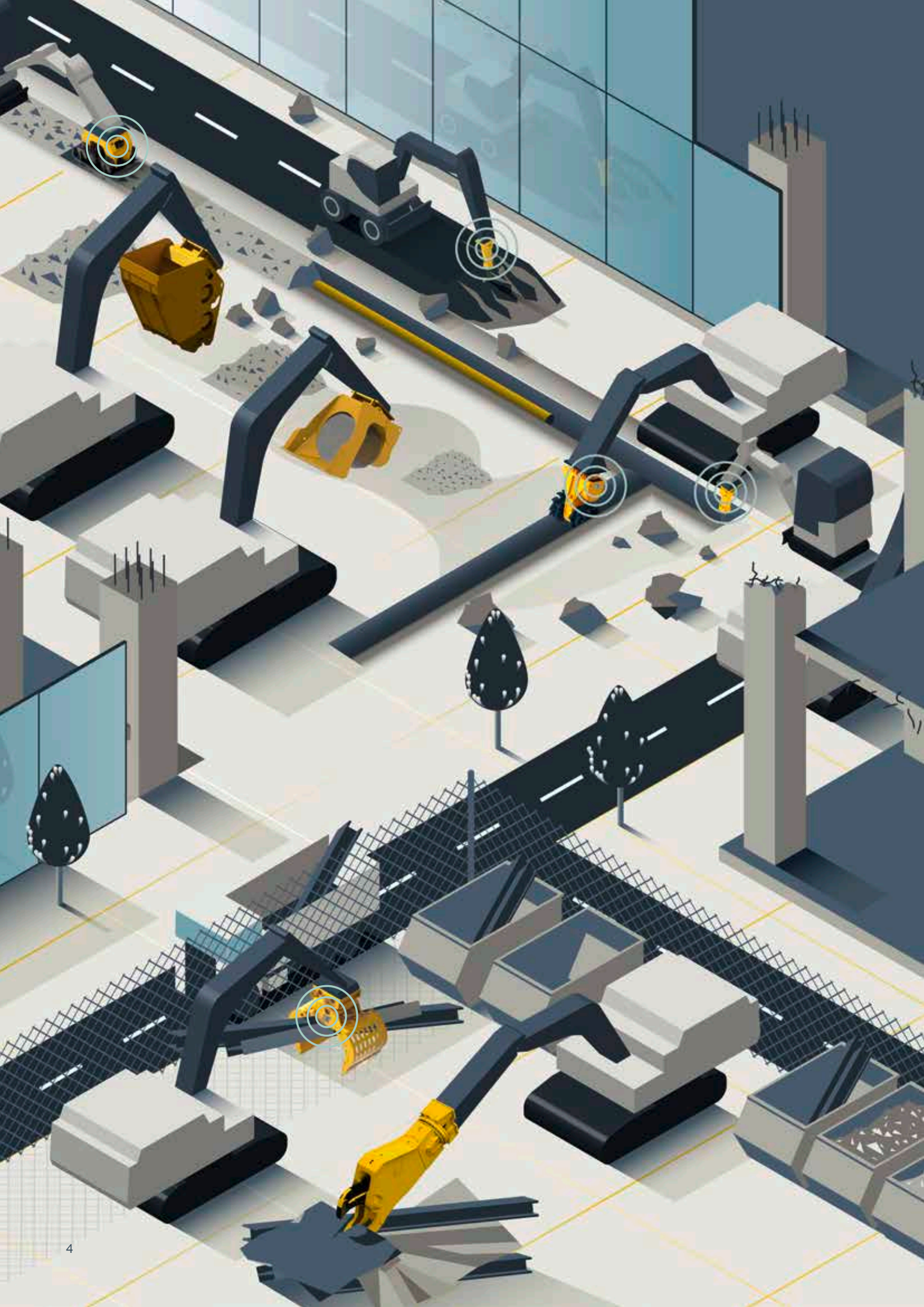

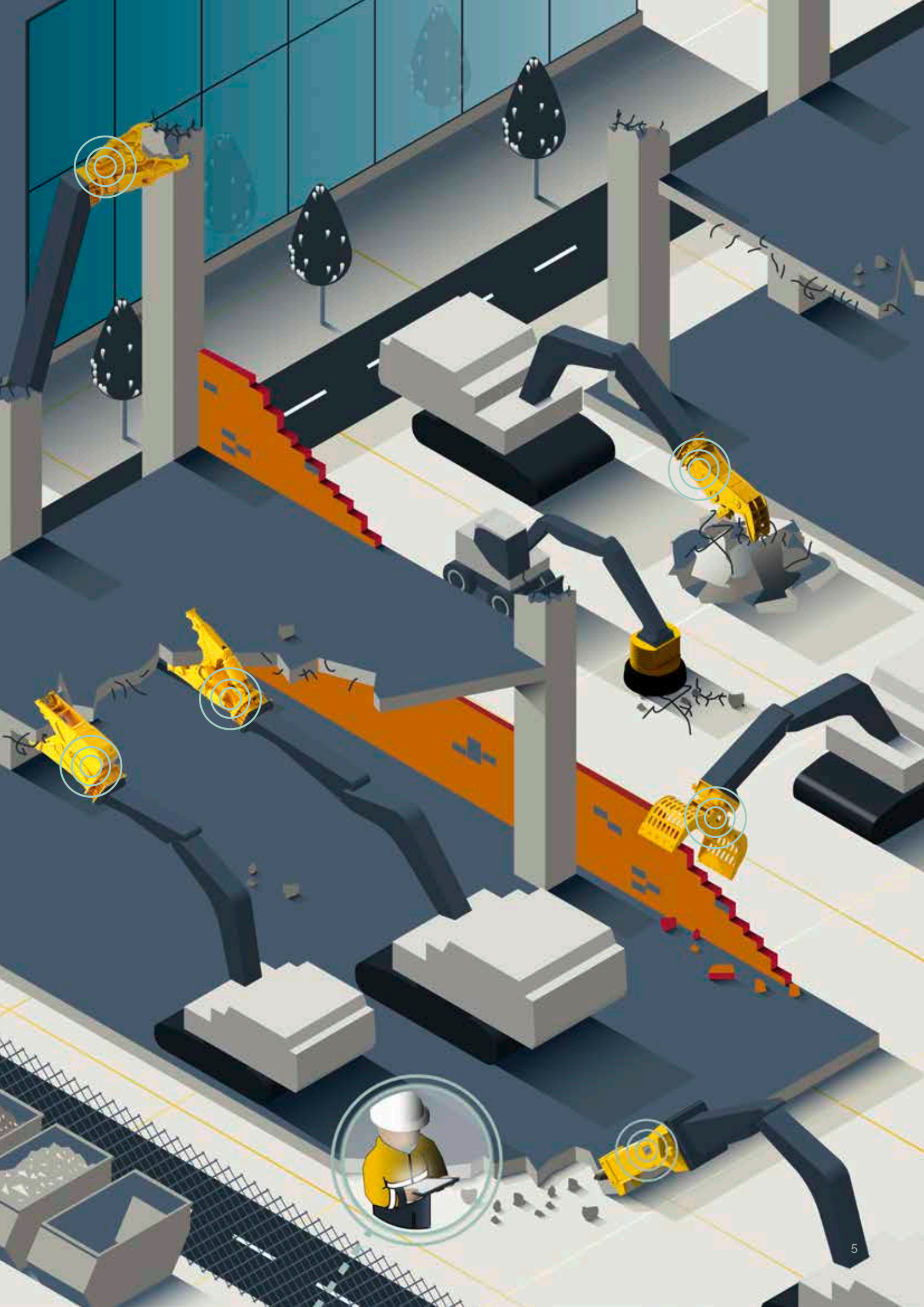



# HATCON™. A new level of control.

HATCON™ (Hydraulic Attachment Tools Connectivity) enables next level fleet management by monitoring operating hours, location and service intervals of your tools. By logging in to My Epiroc, on either your computer or phone, you'll have access to all your data and get notifications when it's time for service.

HATCON™ is available factory mounted or as a retrofit kit for hydraulic attachment tools.

The data from HATCON™ provides a new level of control. Making sure the utilization is evenly distributed, optimizing transport and increasing uptime with pre-planned service stops has never been easier. With connected tools, efficiency and ultimately profitability will increase. The GPS-function is also a good contribution to your anti-theft system.

Epiroc is constantly striving towards giving you the solutions you need to succeed today and the technology to lead tomorrow. By adding HATCON™ to our offer we want to strengthen your business and help you protect your investment.



Visit [www.epiroc.com/hatcon](http://www.epiroc.com/hatcon)



or [www.my.epiroc.com](http://www.my.epiroc.com) for more information.



# A solid choice

Solid Body Breakers are perfect for demolishing light concrete structures and asphalt pavements, both outdoors and indoors, performing earthworks, scaling in underground operations, and cleaning ladles and converters in foundries.

**Energy recovery** automatically utilizes the piston recoil energy to reduce vibration levels with the simultaneous increase of performance.

Maintenance-free high-pressure accumulator with a **patented diaphragm support** delivers consistent performance and high reliability.

The optional automatic lubrication systems **ContiLube® II micro** (SB 52-552) and **ContiLube® II** (SB 702-1102) optimize the lubrication procedure and reduce maintenance and standstills to a minimum.

The integrated **pressure relief valve** protects against overloads.

**Floating fit tool bushing** with a **patented tool locking system** enables quick and easy on-site replacement.

The unique **Solid Body concept** eliminates common parts to enable high durability and a slim, compact, lightweight design.

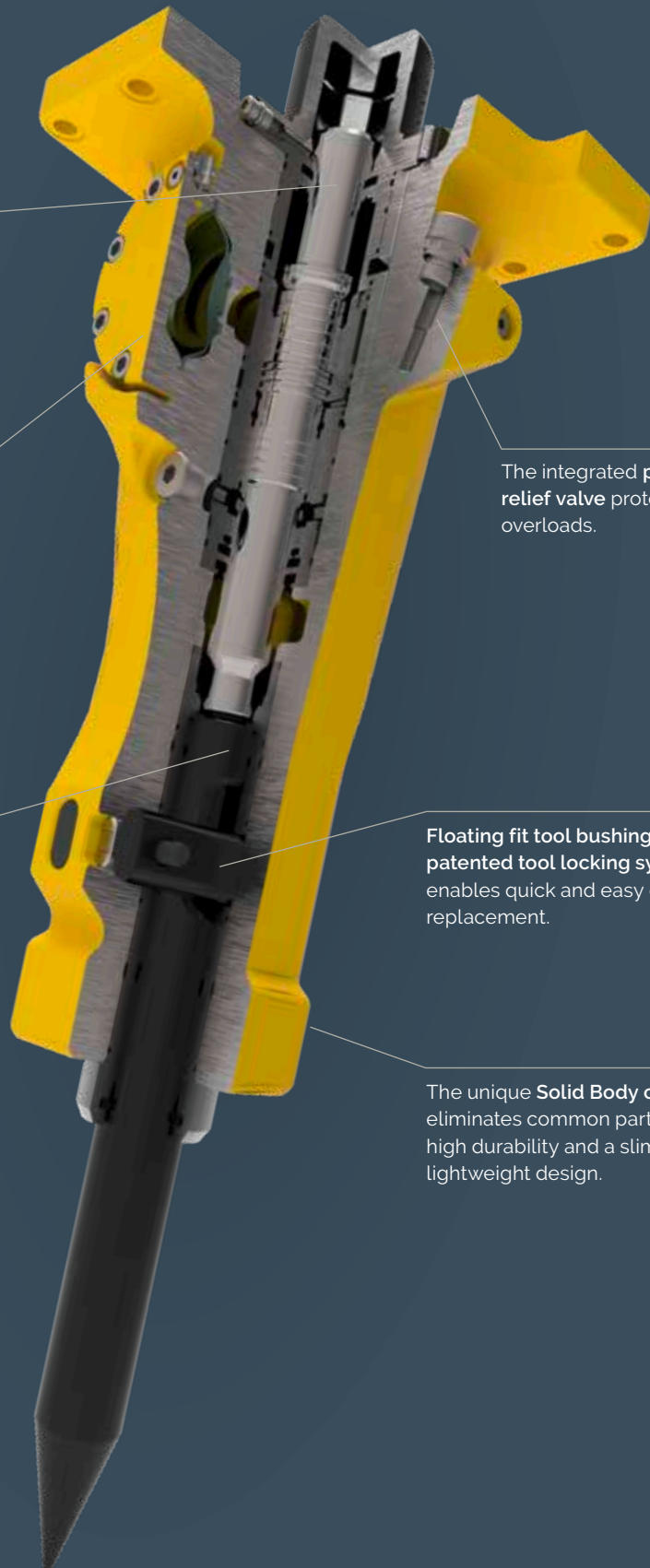



SB range		SB 52	SB 102	SB 152	SB 202	SB 302	SB 452	SB 552	SB 702	SB 1102
Carrier weight class <sup>1</sup>	t	0.7-1.1	1.1-3	1.9-4.5	2.5-6	4.5-9	6.5-13	9-15	10-17	13-24
Service weight <sup>2</sup>	kg	55	90	140	200	300	440	520	720	1,060
Tool diameter	mm	40	45	50	65	80	95	100	105	120
Max. hydraulic input power	kW	7	9	11	17	20	25	29	34	40
Oil flow rate	l/min	12-27	16-35	25-45	35-65	50-80	55-100	65-115	80-120	100-135
Operating pressure	bar	100-150	100-150	100-150	100-150	100-150	100-150	100-150	120-170	130-180
Impact rate	bpm	750-1,700	750-2,300	850-1,900	850-1,800	600-1,400	550-1,250	650-1,150	600-1,050	550-850
Sound power level guaranteed <sup>3</sup>	dB(A)	117	115	114	118	119	122	126	122	123
<b>A</b>	mm	444	571	686	727	807	849	919	1,012	1,166
<b>B</b>	mm	255	265	280	330	400	470	495	520	610

<sup>1</sup> Weights apply to standard carriers only. Any variances must be agreed with Epiroc and/or the carrier manufacturer prior to attachment.

<sup>2</sup> Attachment with standard adapter, screw kit plus working tool.

<sup>3</sup> EN ISO 3744 in accordance with directive 2000/14/EC. Full details of measurement are available in the Safety and Operating instruction of the product. It can be found on [www.epiroc.com/docmine](http://www.epiroc.com/docmine).

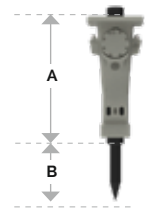

The slim and compact design makes the SB range perfect for working in confined spaces such as inside buildings, along walls or in narrow trenches.



# Good vibes only

The Medium Breakers are ideal for concrete and asphalt demolition work, secondary rock breaking and primary rock excavation on construction sites.

The automatic lubrication system **ContiLube® II** optimizes the lubrication procedure and reduces maintenance and standstills to a minimum.

The **VibroSilenced Plus** concept with non-metallic suspension of percussion mechanism in the fully-sealed box reduces noise and vibration levels.

**Energy recovery** automatically utilizes the piston recoil energy to reduce vibration levels and improve performance.

The optional active two-stage sealing system **DustProtector II** extends the service life of components and lowers grease consumption.



The piston stroke length system **AutoControl** automatically adjusts the output balance during operation thus optimizing performance.

#### Short stroke mode in soft material

Impact energy  Normal impact energy  
Impact rate  High impact rate

#### Long stroke mode in hard material

Impact energy  High impact energy  
Impact rate  Normal impact rate



The patented **StartSelect** system enables the operator to adjust the start-up & shutdown behaviour depending on ground conditions.

#### AutoStop prevents blank firing on solid ground.

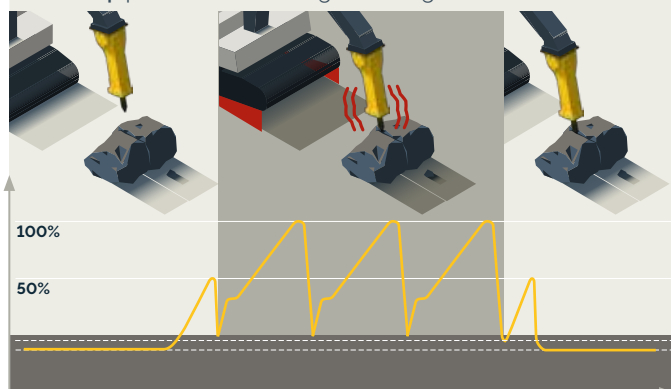

#### AutoStart simplifies positioning in unstable ground conditions.

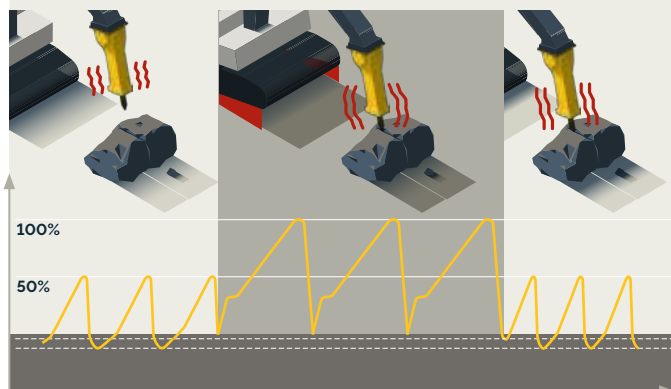

The Medium Breakers are made for a variety of applications, combining efficiency with high performance.

MB range		MB 750	MB 1000	MB 1200	MB 1500	MB 1650
Carrier weight class <sup>1</sup>	t	10-17	12-21	15-26	17-29	19-32
Service weight <sup>2</sup>	kg	750	1,000	1,200	1,500	1,650
Tool diameter	mm	100	110	120	135	140
Max. hydraulic input power	kW	34	39	42	46	51
Oil flow rate	L/min	80-120	85-130	100-140	120-155	130-170
Operating pressure	bar	140-170	160-180	160-180	160-180	160-180
Impact rate	bpm	370-840	350-750	340-680	330-680	320-640
Sound power level guaranteed <sup>3</sup>	dB(A)	117	120	120	123	121
<b>Standard version</b>						
A	mm	1,320	1,458	1,494	1,550	1,573
B	mm	510	570	600	635	670
<b>DustProtector II version</b>						
A	mm	1,400	1,548	1,580	1,630	1,673
B	mm	430	480	515	555	570

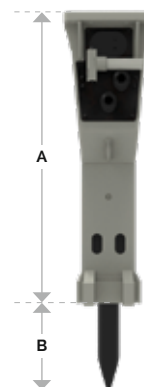

<sup>1</sup> Weights apply to standard carriers only. Any variances must be agreed with Epiroc and/or the carrier manufacturer prior to attachment.

<sup>2</sup> Attachment with standard adapter, screw kit plus working tool

<sup>3</sup> EN ISO 3744 in accordance with directive 2000/14/EC

# A breakthrough performance

Our Heavy Breakers are highly adapted for primary blast-free rock excavation and secondary rock breaking on construction sites and in quarries, surface and underground mines as well as primary demolition of massive reinforced concrete structures.

The automatic lubrication system **ContiLube® II** optimizes the lubrication procedure and reduces maintenance and standstills to a minimum.

**Energy recovery** automatically utilizes the piston recoil energy to reduce vibration levels and improve performance.

The **VibroSilenced Plus** concept with non-metallic suspension of percussion mechanism in the fully-sealed box reduces noise and vibration levels.

The optional active two-stage sealing system **DustProtector II** extends the service life of components and lowers grease consumption.



The built-in pressure cut-off valve **PowerAdapt** prevents overloading.

The piston stroke length system **AutoControl** automatically adjusts the output balance during operation thus optimizing performance.

#### Short stroke mode in soft material

Impact energy  **Normal impact energy**  
 Impact rate  **High impact rate**

#### Long stroke mode in hard material

Impact energy  **High impact energy**  
 Impact rate  **Normal impact rate**

The patented **Intelligent Protection System (IPS)** automatically adjusts the start-up & shutdown behaviour during operation combining easy positioning with maximum blank firing protection.

**IPS** combines the benefits of both AutoStart and Auto-Stop: easy positioning and blank firing protection.

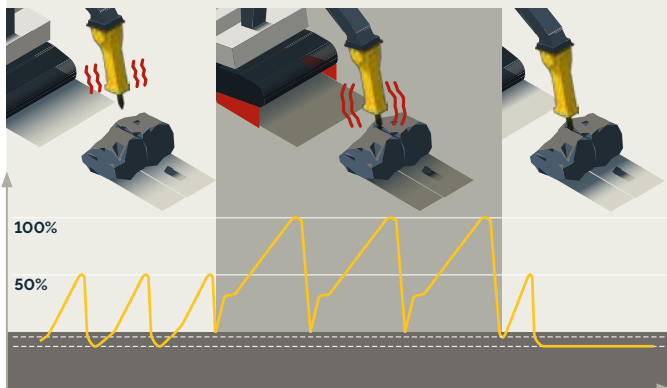

The robust design and high durability make the Heavy Breakers suitable for the toughest jobs.

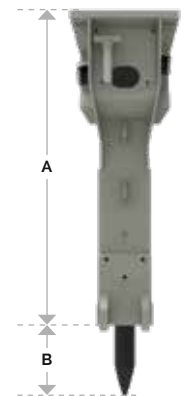

HB range		HB 2000	HB 2500	HB 3100	HB 3600	HB 4100	HB 4700	HB 5800	HB 7000	HB 10000
Carrier weight class <sup>1</sup>	t	22-38	27-46	32-52	35-63	40-70	45-80	58-100	70-120	85-140
Service weight <sup>2</sup>	kg	2,000	2,500	3,100	3,600	4,100	4,700	5,800	7,000	10,000
Tool diameter	mm	145	155	165	170	180	190	200	210	240
Max. hydraulic input power	kW	57	66	81	90	96	108	117	135	159
Oil flow rate	l/min	150-190	170-220	210-270	240-300	250-320	260-360	310-390	360-450	450-530
Operating pressure	bar	160-180	160-180	160-180	160-180	160-180	160-180	160-180	160-180	160-180
Impact rate	bpm	300-625	280-580	280-560	280-560	280-550	280-540	280-480	280-450	250-380
Sound power level guaranteed <sup>3</sup>	dB(A)	120	121	120	123	124	126	121	121	123
<b>Standard version</b>										
A	mm	1,861	2,042	2,209	2,274	2,359	2,454	2,580	2,855	-
B	mm	635	640	675	700	750	790	815	835	-
<b>DustProtector II version</b>										
A	mm	1,926	2,087	2,254	2,318	2,404	2,509	2,635	2,905	3,142
B	mm	570	600	630	650	705	730	760	785	800

<sup>1</sup> Weights apply to standard carriers only. Any variances must be agreed with Epiroc and/or the carrier manufacturer prior to attachment.

<sup>2</sup> Attachment with standard adapter, screw kit plus working tool

<sup>3</sup> EN ISO 3744 in accordance with directive 2000/14/EC

# Think **V**

**Revolution may come in many forms. This one is shaped like a “V”.**

**Why? It's simply more effective, and gentler on the carrier, the economy, and the environment.**

How would you feel about digging a trench without having to go side-to-side to make it even? And save time, money, the environment and your carrier while doing so? Sounds too good to be true. Not with the new V Cutter.

The reliability, robustness and ease of use of our drum cutters have been taken to a new level. Placing the drums in a V-shape enables a cut with a flat base – no material is left untouched between the drums. This means you can dig a more accurate trench much faster. You work this drum cutter like you would a bucket, just go straight. No more zig-zag. The energy and time savings are substantial. It's easier to operate and friendlier for the carrier. In the long run, taking reduced downtime and maintenance into account, it's also a very good investment.



# HexPicks for drum cutters



## Working with drum cutting equipment?

Check out these new picks from Epiroc, the company that recently launched the game-changing V Cutter.

Their unique hexagonal body shape will make your daily maintenance much easier and save you time and costs. Simple but ingenious! Also, thanks to their superior durability, you can rely on maximum performance, minimum wear, and up to 20% longer lifetime.

Suitable for transverse drum cutters, V Cutters and longitudinal cutters, HexPicks will be standard for all deliveries from our factory from 2023.



### Unique design

only available from Epiroc. Simple to replace using a hexagon wrench.

- ⊕ Easy daily maintenance: HexPicks can be unstuck with a hexagon wrench
- ⊕ Better rotation optimizes the resharpener process
- ⊕ HexPicks can be replaced without effort on a jobsite
- ⊕ HexPicks protect the drum's pick box

### QuickSnap retaining system

for fast, easy changing of picks.

- ⊕ Smart retaining clips enable picks to be changed in a matter of seconds
- ⊕ Savings in time of over 50% compared with normal circlip or knock-on retainer

### Up to 20% longer lifetime

(compared to all competing products).

- ⊕ More uptime, less time spent on maintenance
- ⊕ Optimized hardening process
- ⊕ More wear resistant material
- ⊕ Lower costs

# Shape matters

There is a brand-new way to work with rock or concrete wall and surface profiling, trenching, soft rock and frozen soil excavation and demolition. Experience the V-shaped drum cutter revolution.

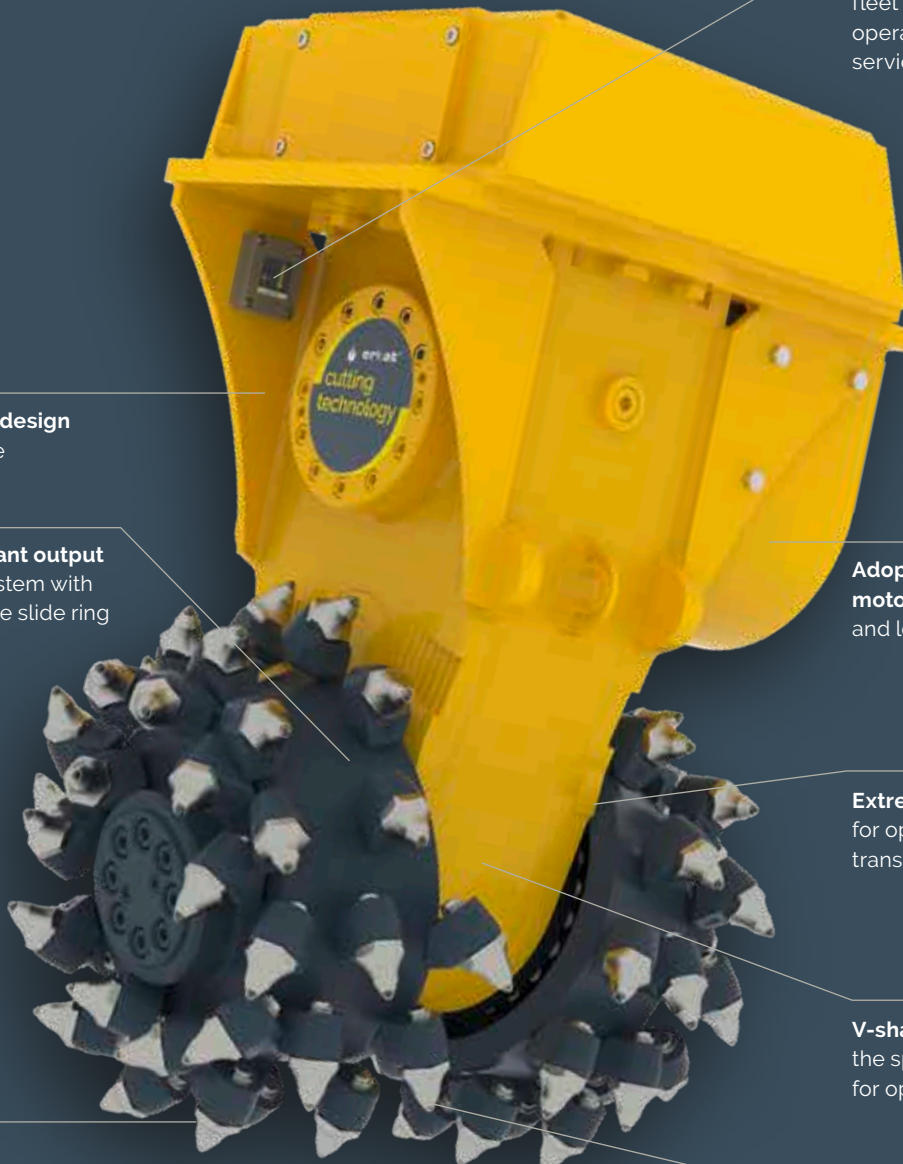

**HATCON™** enables next level fleet management by monitoring operating hours, location and service intervals of your tools.

**Robust housing design**  
for higher uptime

**High load resistant output shaft** bearing system with maintenance-free slide ring seal system

**Adoptable high torque gear motor** for higher productivity and longer motor lifetime.

**Extremely robust spur gears** for optimum energy transmission and reliability.

**V-shaped design** eliminates the space between the drums for optimal efficiency.

**Pick sleeves** are replaceable

**QuickSnap retaining system** for quick and easy pick changing





## Pro bracket – rigid bracket, flexible use

The rigid intermediate bracket offers superior protection for the customer investment with the usual performance. The hydraulic hoses are fed out to the back, in the center of the extension arm, where they are subjected to less mechanical strain and are therefore better protected during work with minimal visual contact with the drum cutter.

Large variety of cutting heads for various applications available

360° endless hydraulic rotation allows optimal positioning and precise handling

Mechanical 360 rotatable bracket with central fixing bolt for easy positioning of drum cutter

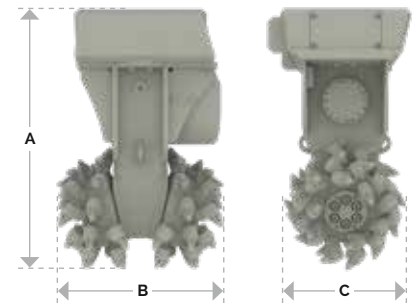

V Cutter		VC 1400	VC 2000	VC 3000
Carrier weight class <sup>1</sup>	t	15-25	20-40	35-55
Service weight <sup>2</sup>	kg	1,400	2,000	3,200
Product weight	kg	1,200	1,700	2,900
Nominal power	kW	80	120	160
<b>A</b>	mm	1,260	1,470	1,690
<b>B</b>	mm	920	1,020	1,160
<b>C</b>	mm	585	720	800
Rotational speed	rpm	80	75	70
Optimum oil flow <sup>3</sup>	l/min	120-170	205-300	270-350
Maximum torque <sup>4</sup>	kNm	11.4	23.4	29.7
Maximum cutting forc <sup>4</sup>	kN	39	65	74
Pick shaft diameter	mm	30	30	30
Number of picks	pcs	60	60	72
Pick speed	m/s	2.4	2.8	2.9
Maximum material hardness	MPa	60	80	100
Maximum oil flow <sup>5</sup>	l/min	200	320	410
Operating pressure, max.	bar	350	350	350



<sup>1</sup> Weights apply to standard carriers only. Any variances must be agreed with Epiroc and/or the carrier manufacturer prior to attachment.

<sup>2</sup> Attachment with standard picks & average-sized adapter plate <sup>3</sup> Various motor variants available per model <sup>4</sup> at 350 bar <sup>5</sup> at 10 bar

# Working side by side

Transverse Drum Cutters are an excellent choice for rock or concrete wall and surface profiling, trenching, soft rock and frozen soil excavation and demolition.

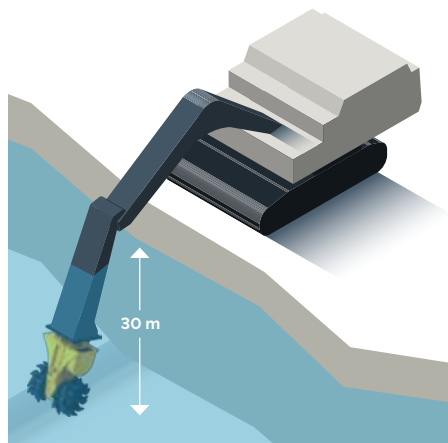

Can be used up to 30 meters underwater without additional installation or modification.

Extremely **robust spur gears** for optimum energy transmission and reliability

**QuickSnap** retaining system (ER 600–3000) for quick and easy pick changing

Large variety of **cutting heads** for various applications available

**Robust housing design** with HARDOX wear protection for higher uptime

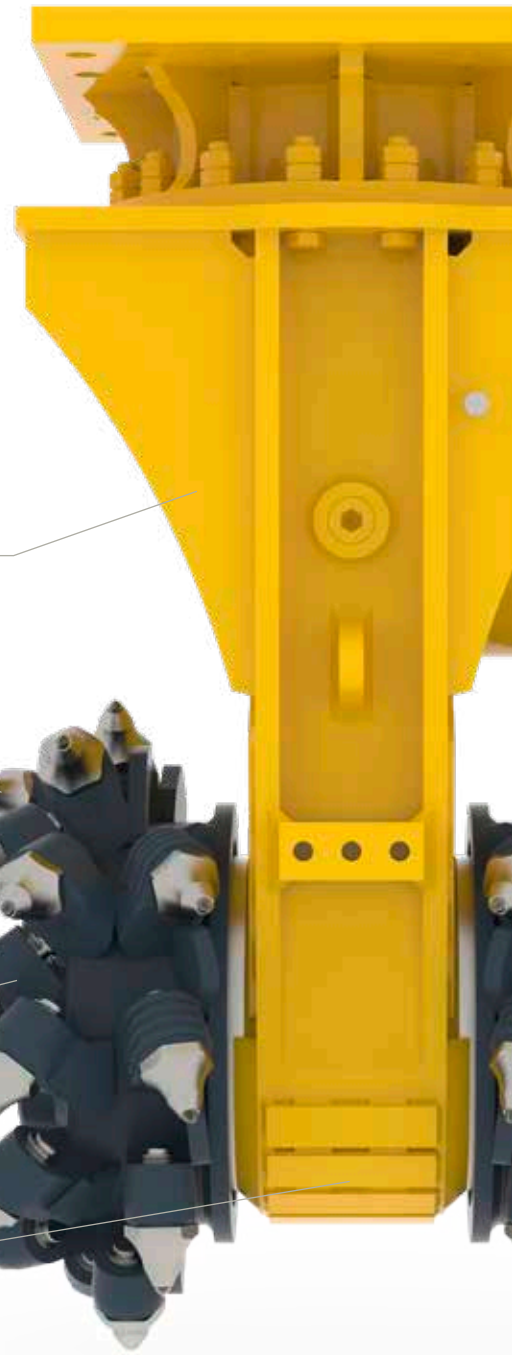

ER range		ER 40X	ER 50X	ER 50	ER 100X	ER 100	ER 250X	ER 250	ER 600
Carrier weight class <sup>1</sup>	t	0.6–2	1–3	1–3	3–8	3–8	8–15	8–15	10–18
Service weight <sup>2</sup>	kg	110	170	200	330	350	520	570	900
Product weight	kg	90	130	160	290	310	450	500	820
Nominal power	kW	13	18	18	30	30	45	45	65
<b>A</b>	mm	495	610	615	805	805	940	965	1130
<b>B</b>	mm	400	400	500	500	610	600	685	795
<b>C</b>	mm	225	225	240	370	370	400	450	575
Rotational speed	rpm	130	150	150	115	115	90	90	80
Optimum oil flow <sup>3</sup>	l/min	17–22	25–38	25–38	52–62	41–62	60–85	60–85	120–150
Max. torque <sup>4</sup>	kNm	0.96	1.42	1.42	3.0	3.0	5.2	5.2	10.1
Max. cutting force <sup>4</sup>	kN	8.53	12.62	11.85	16.2	16.2	26.0	23.2	35.1
Pick shaft diameter	mm	11.4	11.4	16	20	20	20	22	25
Number of picks	pcs	40	40	56	44	64	44	44	48
Max. material hardness	MPa	20	20	20	30	30	40	40	50
Max. oil flow <sup>5</sup>	l/min	40	60	60	90	90	100	100	170
Max. operating pressure	bar	350	350	350	350	350	350	350	350

<sup>1</sup> Weights apply to standard carriers only. Any variances must be agreed with Epiroc and/or the carrier manufacturer prior to attachment.

<sup>2</sup> Attachment with standard picks & average-sized adapter plate <sup>3</sup> Various motor variants available per model <sup>4</sup> at 350 bar <sup>5</sup> at 10 bar



Mechanical **360° rotatable bracket** (ER 50–3000) with central fixing bolt for easy positioning of drum cutter

Adoptable high torque **gear motor** for higher productivity and motor lifetime



High load resistant **output shaft bearing system** with **lubrication-free slide ring seal system**

Pick sleeves (ER 650–5500) are replaceable

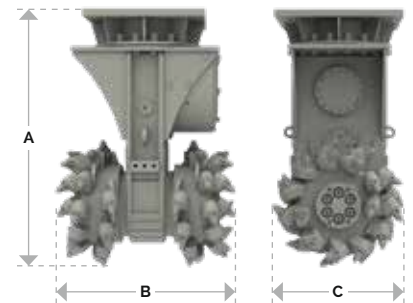
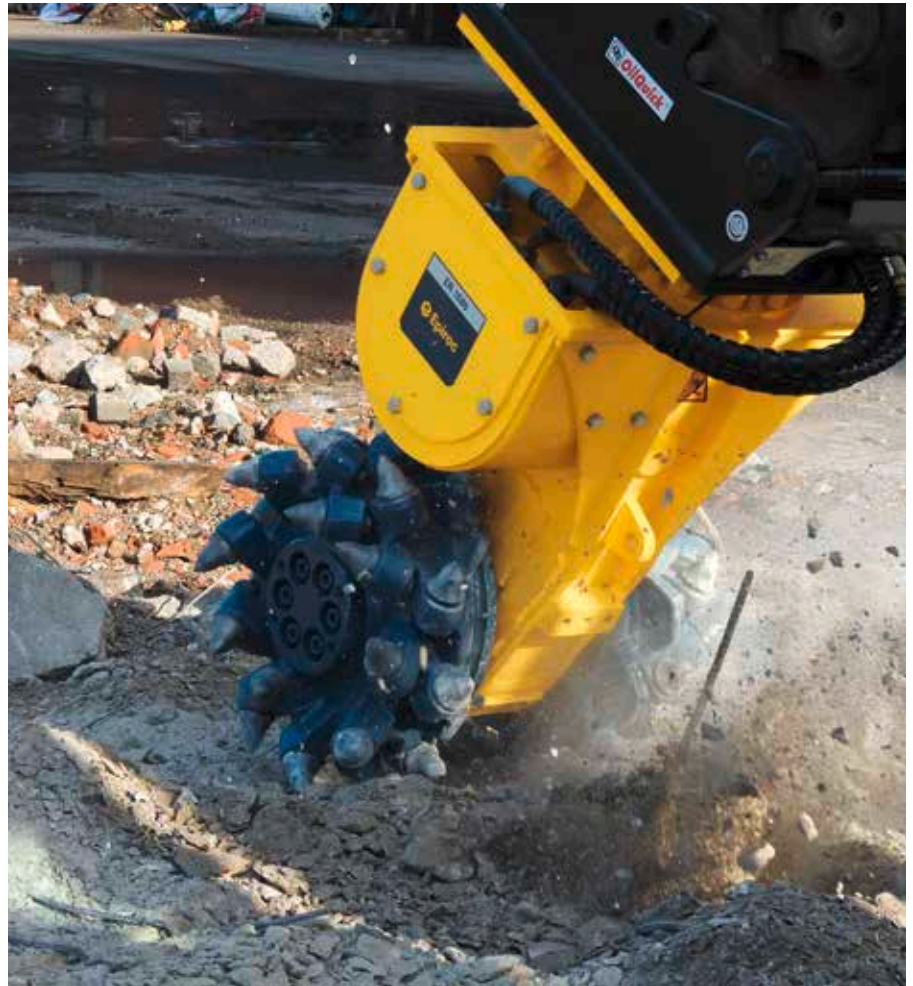

ER range		ER 650	ER 1500X	ER 1500XL	ER 1700	ER 2000X	ER 2000	ER 3000	ER 4000	ER 5500
Carrier weight class <sup>1</sup>	t	15–28	20–40	20–40	30–50	35–55	35–55	50–70	55–75	70–125
Service weight <sup>2</sup>	kg	1,200	2,000	2,100	2,450	2,700	2,900	4,000	5,500	7,000
Product weight	kg	1,000	1,750	1,850	2,200	2,400	2,600	3,500	4,800	6,000
Nominal power	kW	80	120	120	120	160	160	200	280	400
<b>A</b>	mm	1,250	1,425	1,425	1,425	1,600	1,600	1,650	1,874	1,970
<b>B</b>	mm	800	880	1,000	1,040	1,050	1,250	1,330	1,300	1,600
<b>C</b>	mm	585	720	720	720	720	720	805	900	920
Rotational speed	rpm	80	75	75	72	65	65	53	50	48
Optimum oil flow <sup>3</sup>	l/min	140–190	205–300	205–300	290–360	300–390	300–390	350–450	500–750	700–950
Max. torque <sup>4</sup>	kNm	12.4	23.4	23.4	27.9	31.5	31.5	46.8	46.8	111.5
Max. cutting force <sup>4</sup>	kN	43.4	65.0	65.0	77.5	87.5	87.5	116.3	116.3	242.4
Pick shaft diameter	mm	30	30	30	30	30	30	30/38	38	38
Number of picks	pcs	44	44	48	56	56	56	64	78	68
Max. material hardness	MPa	60	80	80	80	100	100	100	120	130
Max. oil flow <sup>5</sup>	l/min	210	320	320	360	410	410	500	800	1,000
Max. operating pressure	bar	350	350	350	350	350	350	350	350	350

<sup>1</sup> Weights apply to standard carriers only. Any variances must be agreed with Epiroc and/or the carrier manufacturer prior to attachment.

<sup>2</sup> Attachment with standard picks & average-sized adapter plate <sup>3</sup> Various motor variants available per model <sup>4</sup> at 350 bar <sup>5</sup> at 10 bar

# Cutting the competition

The integrated hydraulic rotation for our Drum Cutters allows for even more productive, precise and accurate work in challenging tasks.

Extremely **robust spur gears** for optimum energy transmission and reliability



**QuickSnap** retaining system (ERC 600–3000) for quick and easy pick changing

High load resistant **output shaft bearing system** with **lubrication-free slide ring seal system**

**Large variety of cutting heads** for various applications available



ERC range		ERC 50	ERC 100	ERC 250	ERC 600	ERC 650	ERC 1500X	ERC 1500XL
Carrier weight class <sup>1</sup>	t	1–3	3–8	8–15	10–18	15–28	20–40	20–40
Service weight <sup>2</sup>	kg	340	530	950	1,280	1,810	2,700	2,800
Product weight	kg	300	490	880	1,200	1,610	2,450	2,550
Nominal power	kW	18	30	45	65	80	120	120
<b>A</b>	mm	795	1,085	1,325	1,500	1,665	1,870	1,870
<b>B</b>	mm	500	610	685	795	800	880	1,000
<b>C</b>	mm	240	370	450	575	585	720	720
Rotational speed	rpm	150	115	90	80	80	75	75
Optimum oil flow <sup>3</sup>	L/min	25–38	41–62	60–85	120–150	140–190	205–300	205–300
Max. torque <sup>4</sup>	kNm	1.42	3.0	5.2	10.1	12.4	23.4	23.4
Max. cutting force <sup>4</sup>	kN	11.85	16.2	23.2	35.1	42.4	65.0	65.0
Pick shaft diameter	mm	16	20	22	25	30	30	30
Number of picks	pcs	56	64	44	48	44	44	48
Max. material hardness	MPa	20	30	40	50	60	80	80
Max. oil flow <sup>5</sup>	L/min	60	90	100	170	210	320	320
Max. operating pressure	bar	350	350	350	350	350	350	350
Max. oil flow (rotation) <sup>5</sup>	L/min	10	10	30	30	40	40	40
Max. operating pressure (rotation)	bar	160	160	160	160	160	160	160

<sup>1</sup> Weights apply to standard carriers only. Any variances must be agreed with Epiroc and/or the carrier manufacturer prior to attachment.

<sup>2</sup> Attachment with standard picks & average-sized adapter plate <sup>3</sup> Various motor variants available per model <sup>4</sup> at 350 bar <sup>5</sup> at 10 bar

360° endless **hydraulic rotation** allows optimal positioning and precise handling

Adoptable high torque **gear motor** for higher productivity and motor lifetime

Pick sleeves (ERC 650–3000) are replaceable



**Robust housing design** with HARDOX wear protection for higher uptime



ERC range		ERC 1700	ERC 2000	ERC 3000
Carrier weight class <sup>1</sup>	t	30–50	35–55	50–70
Service weight <sup>2</sup>	kg	3.240	3.600	5.700
Product weight	kg	2.990	3.300	5.200
Nominal power	kW	120	160	200
<b>A</b>	mm	1.875	1.990	2.220
<b>B</b>	mm	1.040	1.250	1.330
<b>C</b>	mm	720	720	805
Rotational speed	rpm	72	65	53
Optimum oil flow <sup>3</sup>	L/min	290–360	300–390	350–450
Max. torque <sup>4</sup>	kNm	27,9	31,5	46,8
Max. cutting force <sup>4</sup>	kN	77,5	87,5	116,3
Pick shaft diameter	mm	30	30	30/38
Number of picks	pcs	56	56	64
Max. material hardness	MPa	80	100	100
Max. oil flow <sup>5</sup>	L/min	400	410	500
Max. operating pressure	bar	350	350	350
Max. oil flow (rotation) <sup>5</sup>	L/min	40	40	60
Max. operating pressure (rotation)	bar	160	160	160

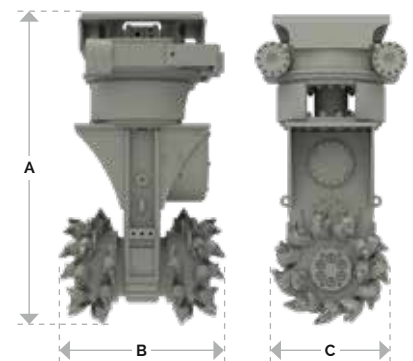

<sup>1</sup> Weights apply to standard carriers only. Any variances must be agreed with Epiroc and/or the carrier manufacturer prior to attachment. <sup>2</sup> Attachment with standard picks & average-sized adapter plate  
<sup>3</sup> Various motor variants available per model <sup>4</sup> at 350 bar <sup>5</sup> at 10 bar

# One machine – various applications



## Pro bracket – rigid bracket, flexible use

The rigid intermediate bracket offers guaranteed protection for the customer investment with the usual performance. The hydraulic hoses are fed out to the back, in the centre of the extension arm protection, are subjected to less mechanical strain and are therefore better protected during work with minimal visual contact with the drum cutter in particular. Available for ER 650 – ER 2000.



## HATCON™ – A new level of control

HATCON™ enables next level fleet management by monitoring operating hours, location and service intervals of your tools. Available for ER 100 – ER 5500<sup>1</sup>.

## Breathe deeply with our dust extraction systems

### Water spraying system

The solution is to spray water directly onto the cutting head area so the water is applied at the actual location itself. Available for ER 40 – ER 5500<sup>1</sup>.



### Dust suction hood

For indoor use where water spraying is not possible, we also offer small drum cutter models with a dust suction hood for dry dust collection. Available for ER 40 – ER 100<sup>1</sup>.



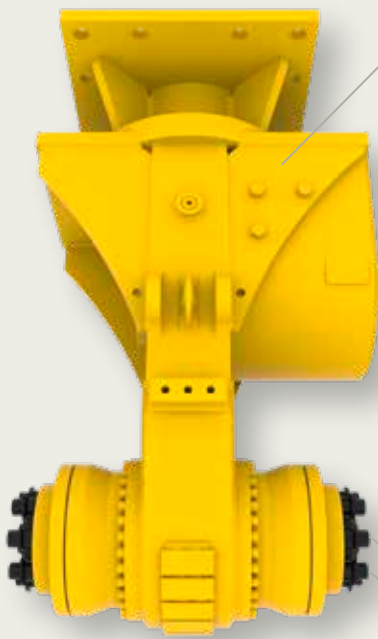

### ER without drums

Our drum cutter allows high flexibility on site by changing just the cutting heads for different applications.

We also offer special solutions for extraordinary applications:

- Underwater Kits for applications up to 2,000 m depth
- Arctic Kits for extreme low temperatures up to  $-50^{\circ}\text{C}$
- High temperature kits for working in hot environment such as in steel factories



### Standard cutting head

The standard cutting head covers the most common applications.



### Cutting wheel

For narrow trenches and targeted slots in rock, concrete or asphalt. Available for ER 50 – ER 3000<sup>1</sup>.

## Special heads

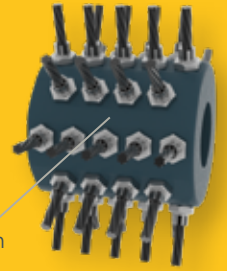

### Brush head

For cleaning surfaces such as steel plates, concrete walls and shotcrete walls. Available for ER 40 – ER 650.



### Profiling head

For a better surface finish such as for tunnel lining or diaphragm walls. Available for ER 250 – ER 3000.



### Wood cutting head

For wood and tree stump grinding. Available for ER 250 – ER 1500.



### Mixing head

For soil mixing and conditioning in soft to medium hard grounds. Available for ER 600 – ER 2000.



### High production head

For soft rock mineral excavation. Available for ER 650 – ER 5500.

<sup>1</sup> Also suitable for corresponding ERC models

# Diggin' ditches

Axial Drum Cutters are designed for narrow trenching, pile head removal and gutter cleaning.



Robust housing for higher uptime

Adoptable **high torque radial piston motor** for higher productivity

Strong and **lubrication-free bearing system** for minimum downtime

**Large variety of cutting heads** for various applications available

Cutter head can be replaced by auger for soft rock drilling



ER-L range		ER 100L	ER 250L	ER 400L	ER 450L	ER 600L
Carrier weight class <sup>1</sup>	t	3-8	8-15	12-17	12-17	15-22
Service weight <sup>2</sup>	kg	250	410	440	450	660
Product weight <sup>3</sup>	kg	210	340	365	375	580
Nominal power	kW	30	45	65	65	65
<b>A</b>	mm	810	1,130	1,130	1,160	1,340
<b>B</b>	mm	310	355	355	380	550
<b>C</b>	mm	370	400	400	450	535
Rotational speed	rpm	110	90	80	80	80
Optimum oil flow <sup>4</sup>	l/min	52-62	60-85	120-150	120-150	120-150
Max. torque <sup>5</sup>	kNm	3.12	5.2	10.4	10.4	10.4
Max. cutting force <sup>5</sup>	kN	16.9	26.0	52.0	46.2	38.9
Pick shaft diameter	mm	20	20	20	22	22
Number of picks	pcs	32	40	40	30	42
Max. oil flow <sup>6</sup>	l/min	90	100	170	170	170
Max. operating pressure	bar	350	350	350	350	350

<sup>1</sup> Weights apply to standard carriers only. Any variances must be agreed with Epiroc and/or the carrier manufacturer prior to attachment.

<sup>2</sup> Attachment with standard picks & average-sized adapter plate <sup>3</sup> Various motor variants available per model <sup>4</sup> at 350 bar <sup>5</sup> at 10 bar



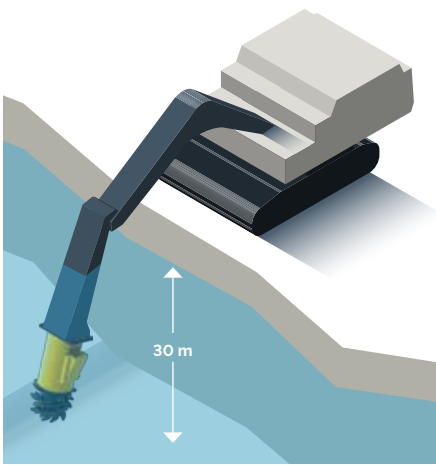

Can be used up to 30 meters underwater without additional installation or modification.

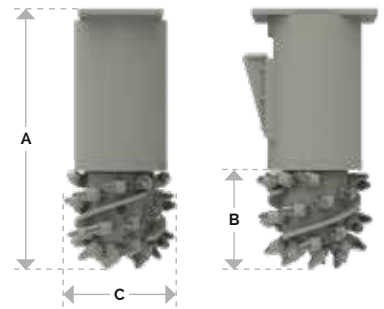

<b>ER-L range</b>		<b>ERL 700</b>	<b>ERL 1100</b>	<b>ER 1500L</b>	<b>ER 2000L</b>
Carrier weight class <sup>1</sup>	t	15-25	20-35	20-40	35-55
Service weight <sup>2</sup>	kg	700	900	1,450	1,800
Product weight	kg	600	660	1,200	1,500
Nominal power	kW	70	120	120	160
<b>A</b>	mm	1,230	1,270	1,440	1,500
<b>B</b>	mm	390	430	590	600
<b>C</b>	mm	450	500	680	720
Rotational speed	rpm	75	75	75	65
Optimum oil flow <sup>3</sup>	l/min	160	240-300	200-300	300-390
Max. torque <sup>4</sup>	kNm	11.7	23.4	23.4	33.5
Max. cutting force <sup>4</sup>	kN	52.0	93.6	68.8	93.0
Pick shaft diameter	mm	22	30	30	30
Number of picks	pcs	30	26	24	28
Max. oil flow <sup>5</sup>	l/min	200	320	320	410
Max. operating pressure	bar	350	350	350	350

<sup>1</sup> Weights apply to standard carriers only. Any variances must be agreed with Epiroc and/or the carrier manufacturer prior to attachment.

<sup>2</sup> Attachment with standard picks & average-sized adapter plate <sup>3</sup> Various motor variants available per model <sup>4</sup> at 350 bar <sup>5</sup> at 10 bar

# Know the drill

Based on our Drum Cutter technology, the auger drives are ideal for challenging soil and soft rock drilling operations.

Compact housing design for easy handling

High torque radial piston motor for higher productivity



Strong and lubrication-free bearing system for minimum downtime

Quick auger exchange for high flexibility

Large variety of augers for various applications available



## Soil Classifications<sup>5</sup>

 EBK-F	1	Topsoil
	2	Liquid Soil
 EBK-RF	3	Soil easy to excavate
	4	Soil medium hard to excavate
 EBK-R3	4	Soil medium hard to excavate
	5	Soil hard to excavate
 EBK-R3 HD	6	Rock easy to excavate & similar soil
	5	Soil hard to excavate
	7	Rock hard to excavate (max. 60–80 MPa)

Choice of drill bits for various ground conditions

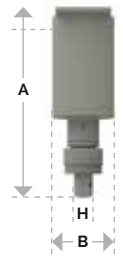
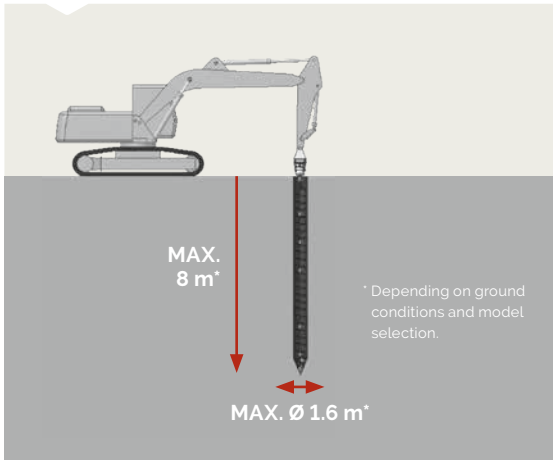

ADU range		ADU 100	ADU 250	ADU 450	ADU 600	ERL 700	ERL 1100	ADU 1500	ADU 2000
Carrier weight class <sup>1</sup>	t	3-8	8-15	8-17	14-22	15-30	18-35	18-40	30-55
Service weight <sup>2</sup>	kg	280	420	445	750	800	1,090	1,370	1,900
Product weight	kg	170	270	290	460	510	540	850	1,250
Nominal power	kW	30	45	65	65	70	120	120	160
<b>A</b>	mm	900	810	810	1,260	1,090	1,090	1,200	1,250
<b>B</b>	mm	300	350	360	350	400	400	600	660
<b>H</b> (hexagonal connector size)	mm	80	80	80	80/120/160	160	160	80/120/160	120/160
Rotational speed	rpm	50-110	40-80	40-80	40-80	50-90	50-70	50-70	30-60
Optimum oil flow <sup>3</sup>	L/min	30-60	40-75	75-150	75-150	105-170	200-300	200-300	200-360
Max. torque <sup>4</sup>	kNm	3.12	5.2	10.4	10.4	11.7	23.4	23.4	33.5
Max. oil flow	L/min	90	85	170	170	200	320	320	400
Max. operating pressure	bar	350	350	350	350	350	350	350	350
<b>Drilling capabilities</b>									
Max. recommended drilling depth	mm	3,500	5,000	5,000	6,000	6,000	7,000	7,000	8,000
Max. recommended drilling diameter (Soil class 1-3 <sup>5</sup> )	mm	400	500	800	900	1,000	1,500	1,500	1,600
Max. recommended drilling diameter (Soil class 4-5 <sup>5</sup> )	mm	300	400	600	700	900	1,200	1,200	1,500
Max. recommended drilling diameter (Soil class 6-7 <sup>5</sup> )	mm	-	300	500	500	600	900	900	1,100

<sup>1</sup> Weights apply to standard carriers only. Any variances must be agreed with Epiroc and/or the carrier manufacturer prior to attachment.  
<sup>2</sup> Attachment with average-sized adapter plate incl. hinge bracket <sup>3</sup> at 200 bar <sup>4</sup> at 350 bar <sup>5</sup> according to DIN 18300



### Posthole borer LPHB-M

Carrier weight class <sup>3</sup>	t	1-3
Product weight	kg	31
Oil flow rate	L/min	20-60
Operating pressure	bar	100-140
Rotational speed	rpm	80-200
Maximum torque	Nm	450

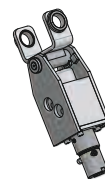

<sup>3</sup> Weights apply to standard carriers only. Any variances must be agreed with Epiroc and/or the carrier manufacturer prior to attachment.

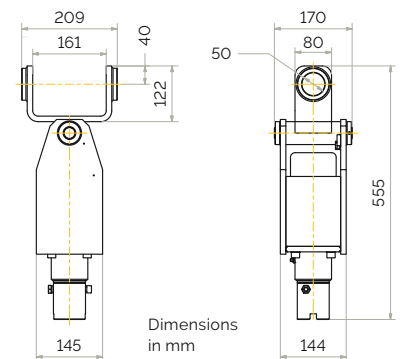

Augers	Diameter mm	Length mm	Weight kg
Auger	90	870	5.8
Auger	150	870	10.3
Auger	200	870	13.7
Auger	250	870	17.2
Auger	280	870	20.6
Auger	350	870	24.0
Extension rod	-	500	4.7



# On solid ground

The Hydraulic Compactors are designed for effectively compacting soil in trenching, ground levelling, embankment construction, driving in posts, sheet piling and other formworks.

Optional 360° endless **hydraulic rotation** allows optimal positioning and precise handling (HC 350-1050).

No need for manual greasing thanks to the **permanent oil splash lubrication**.

To improve force distribution and thus lessen the strain, **the outward shock mounts are tilted 15°**.

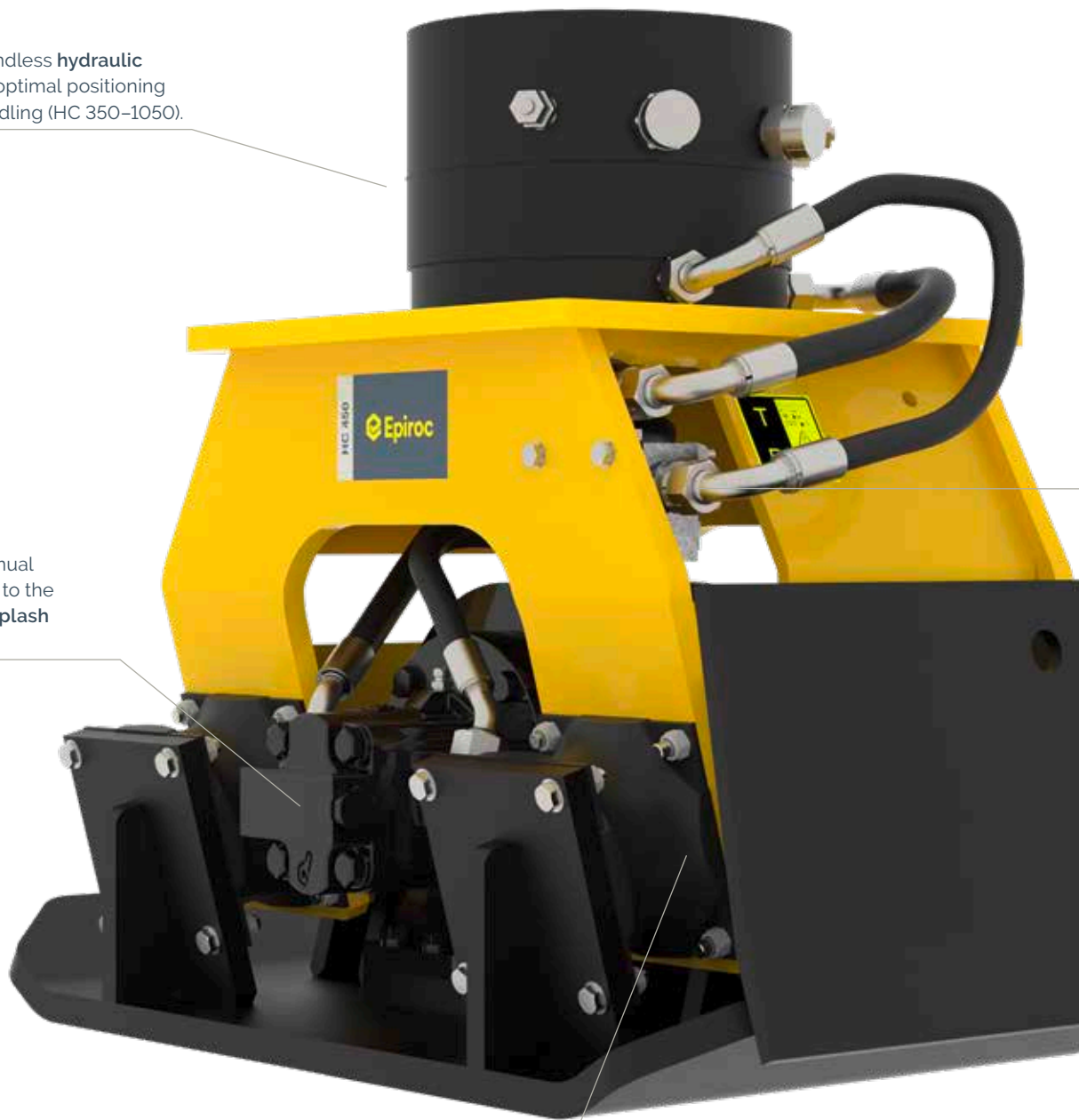

## HC range

		HC 150 <sup>3</sup>	HC 350 <sup>3</sup>	HC 450 <sup>3</sup>	HC 850 <sup>3</sup>	HC 1050 <sup>3</sup>
<b>Static version</b>						
Carrier weight class <sup>1</sup>	t	1-3	3-8	4-9	9-20	20-40
Service weight <sup>2</sup>	kg	160	330	450	890	1,130
Product weight	kg	140	296	408	832	1,040
<b>A</b>	mm	486	623	622	764	786
<b>B</b>	mm	295	475	610	710	864
<b>C</b>	mm	721	846	929	1,272	1,364
<b>Rotating version</b>						
Carrier weight class <sup>1</sup>	t	-	4-8	5-9	9-20	20-40
Service weight <sup>2</sup>	kg	-	450	570	1,010	1,320
Product weight	kg	-	416	528	952	1,225
<b>A</b>	mm	-	913	912	1,054	1,088
<b>B</b>	mm	-	475	610	710	864
<b>C</b>	mm	-	846	929	1,272	1,364
<b>Static and rotating version</b>						
Force	kN	14	23	36	73	105
Number of revolutions	rpm	2,100	2,100	2,200	2,200	2,200
Frequency	Hz	35	35	37	37	37
Compaction coverage	m <sup>2</sup>	0.17	0.31	0.40	0.68	0.90
Oil flow rate	l/min	30	57	76	114	151
Max. operating pressure	bar	150	160	160	200	200
Oil flow rate (rotation)	l/min	-	25	25	25	25
Max. operating pressure (rotation)	bar	-	320	320	320	320

<sup>1</sup> Weights apply to standard carriers only. Any variances must be agreed with Epiroc and/or the carrier manufacturer prior to attachment.

<sup>2</sup> Attachment with average-sized adapter plate

<sup>3</sup> Drainage line required

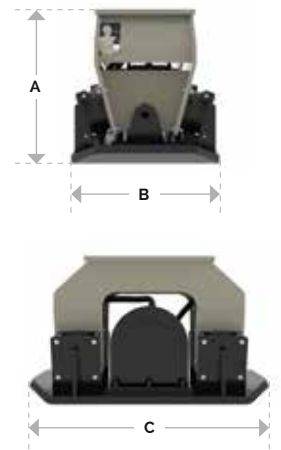

The integrated **flow and pressure control valve** prevents overloading.

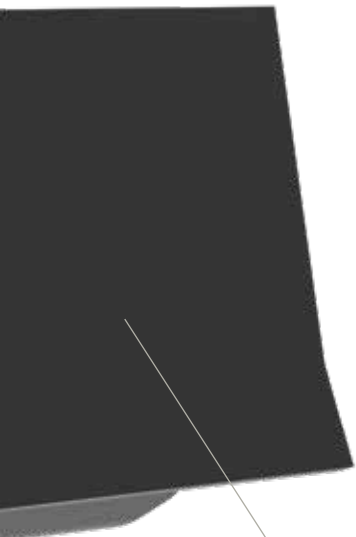

Optional **backfill blades** for clearing and moving soil.



Our low-noise Hydraulic Compactors work quickly, are simple to operate and make positioning easy.

# When the demand is high

Our Concrete Busters are perfectly designed for primary demolition of wide reinforced concrete structures.

360° endless **hydraulic rotation** allows optimal positioning and precise handling.

Faster working cycles thanks to the integrated **speed valve**.

Full hydraulic cylinder protection thanks to the **piston rod guards**.



**Cutting blades** are both replaceable and reversible.

Two powerful hydraulic cylinders deliver virtually constant closing force for high productivity.

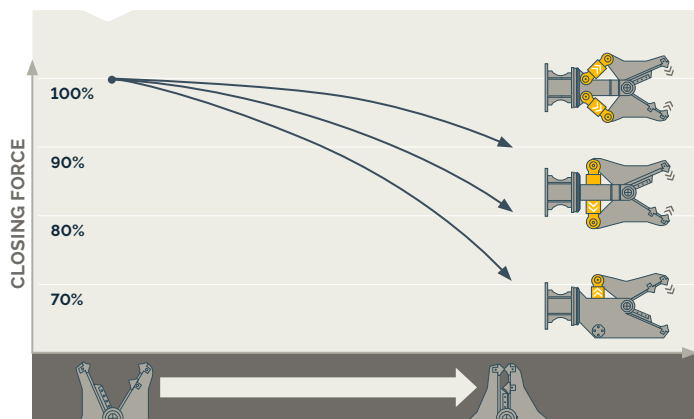

Two independently moving jaws eliminate displacement force, thus lowering stress levels.

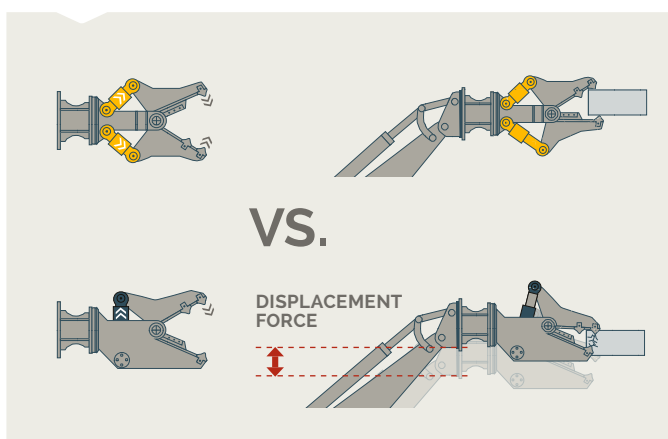

The lightweight Concrete Busters are ideal for high reach deconstruction. Perfect for demolition sites in residential areas.

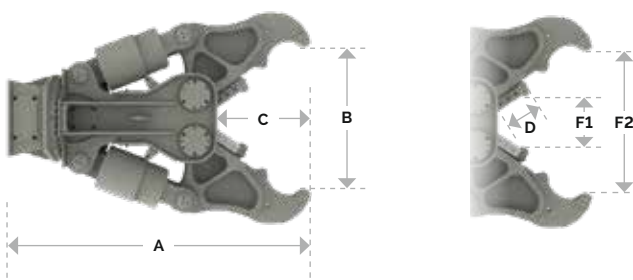

CB range		CB 350	CB 750	CB 950	CB 2500	CB 4500	CB 5500	CB 7500
Carrier weight class <sup>1</sup>	t	2-6	6-13	11-17	20-35	40-55	50-65	70-85
Service weight <sup>2</sup>	kg	320	730	940	2,600	4,650	5,500	7,400
Product weight	kg	290	617	794	2,370	4,295	5,080	6,750
<b>A</b>	mm	907	1,374	1,700	2,260	2,650	2,950	3,300
<b>B</b>	mm	380	480	680	1,100	1,400	1,600	1,800
<b>C</b>	mm	219	269	324	750	810	1,060	1,120
<b>D</b>	mm	90	140	140	240	280	350	350
<b>F1</b>	t	199	236	312	360	400	690	960
<b>F2</b>	t	40	45	55	100	130	150	190
Cycle time (opening/closing) <sup>3</sup>	sec	3.8/3.0	3.4/2.6	5.8/5.0	3.8/2.8	3.6/2.6	4.1/3.5	4.8/4.7
Oil flow rate (opening & closing)	l/min	50-90	90-180	90-180	250	300-400	350-450	550
Max. operating pressure (opening & closing)	bar	300	350	350	350	350	350	350
Oil flow rate (rotation)	l/min	5-10	20-25	20-25	35-50	50	50	50
Max. operating pressure (rotation)	bar	170	210	210	170	115	115	115

<sup>1</sup> Weights apply to standard carriers only. Any variances must be agreed with Epiroc and/or the carrier manufacturer prior to attachment.

<sup>2</sup> Attachment with average-sized adapter plate

<sup>3</sup> With max. oil flow

# Cutting edge

Our multi-purpose Combi Cutters with various jaw type options can be used flexibly in primary demolition and secondary reduction of concrete structures as well as cutting steel structures at demolition sites.

360° endless **hydraulic rotation** allows optimal positioning and precise handling.

Faster working cycles thanks to the integrated **speed valve**.

Full hydraulic cylinder protection thanks to the **piston rod guards**.

**CAPS**, the Coupling and Positioning System, makes it easy to switch jaw types on site to suit the work in hand.



**Crushing teeth** of U- and P-version are replaceable.

**Cutting blades** of the U-, S- and P-versions are both replaceable and reversible.





Two powerful hydraulic cylinders deliver virtually constant closing force for high productivity.

Our highly dependable and versatile Combi Cutters feature two powerful hydraulic cylinders for superior productivity.

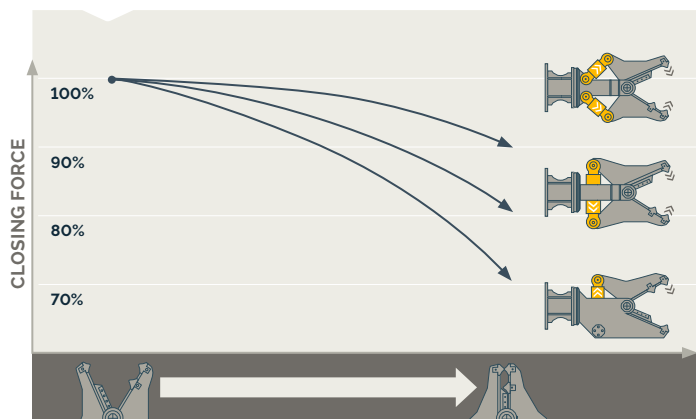

Two independently moving jaws eliminate displacement force, thus lowering stress levels.

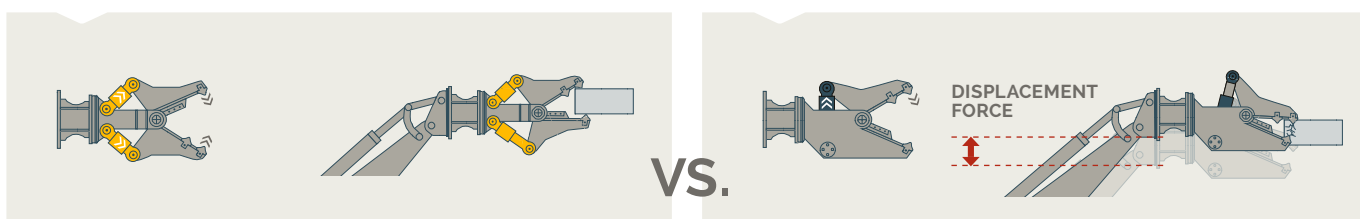

**CC range**

		CC 1600	CC 2300	CC 3100	CC 3700	CC 5000	CC 7000
Carrier weight class <sup>1</sup>	t	13-23	20-30	25-40	30-50	45-65	58-85

**Universal version (U)**



Service weight <sup>2</sup>	kg	1,625	2,290	3,130	3,720	5,300	7,100
Product weight	kg	1,454	2,080	2,860	3,420	4,850	6,450
A	mm	1,862	2,159	2,341	2,420	2,960	3,100
B	mm	700	750	870	1,000	1,300	1,400
C	mm	490	660	700	765	1,090	1,150
D	mm	350	350	350	525	525	525
F1	t	197	257	430	510	620	830
F2	t	57	70	104	126	155	180

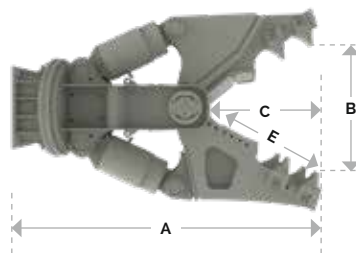

**Steel cutting version (S)**



Service weight <sup>2</sup>	kg	1,550	2,160	2,865	3,400	4,960	6,750
Product weight	kg	1,350	1,950	2,635	3,110	4,510	6,000
A	mm	1,786	1,983	2,059	2,320	2,800	2,930
B	mm	380	415	400	440	720	750
C	mm	385	485	465	625	865	900
D	mm	380	380	380	525	875	875
F1	t	197	294	430	510	620	830
F2	t	61	87	145	147	198	205

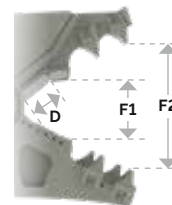

**Pulverizer version (P)**



Service weight <sup>2</sup>	kg	2,070	2,670	3,500	4,300	-	-
Product weight	kg	1,870	2,460	3,265	3,975	-	-
A	mm	1,887	2,110	2,265	2,390	-	-
B	mm	830	747	832	960	-	-
C	mm	540	605	643	692	-	-
D	mm	140	140	140	190	-	-
E	mm	630	720	765	852	-	-
F1	t	197	264	430	510	-	-
F2	t	54	71	112	129	-	-

**Universal (U), Steel cutting (S) & Pulverizer (P) version**

Cycle time (opening/closing)	sec	1.3/1.3	1.7/1.6	3.1/2.9	3.0/2.8	3.7/3.2	3.7/3.7
Oil flow rate	l/min	150-250	150-250	150-250	220-350	350-450	450-550
Max. operating pressure	bar	350	350	350	350	350	350
Oil flow (rotation)	l/min	35-50	35-50	35-50	35-50	50	50
Max. operating pressure (rotation)	bar	170	170	170	170	115	115

<sup>1</sup> Weights apply to standard carriers only. Any variances must be agreed with Epiroc and/or the carrier manufacturer prior to attachment.

<sup>2</sup> Attachment with average-sized adapter plate

# Levelling the working field

The straight design of the Demolition Pulverizer makes it optimally suited for primary demolition and secondary reduction of non-reinforced and reinforced concrete structures.

## PERFORMANCE BOOSTER

Performance Booster (optional) – get the job done faster using less fuel

360° endless hydraulic rotation allows optimal positioning and precise handling.

Lower maintenance thanks an optimized wear part design.

Robust design with no cylinder rod protection needed.

Speed valve used in the standard version

Cutting blades are both replaceable and reversible.

Wear plate fixing system makes it even easier to change wear plates onsite.

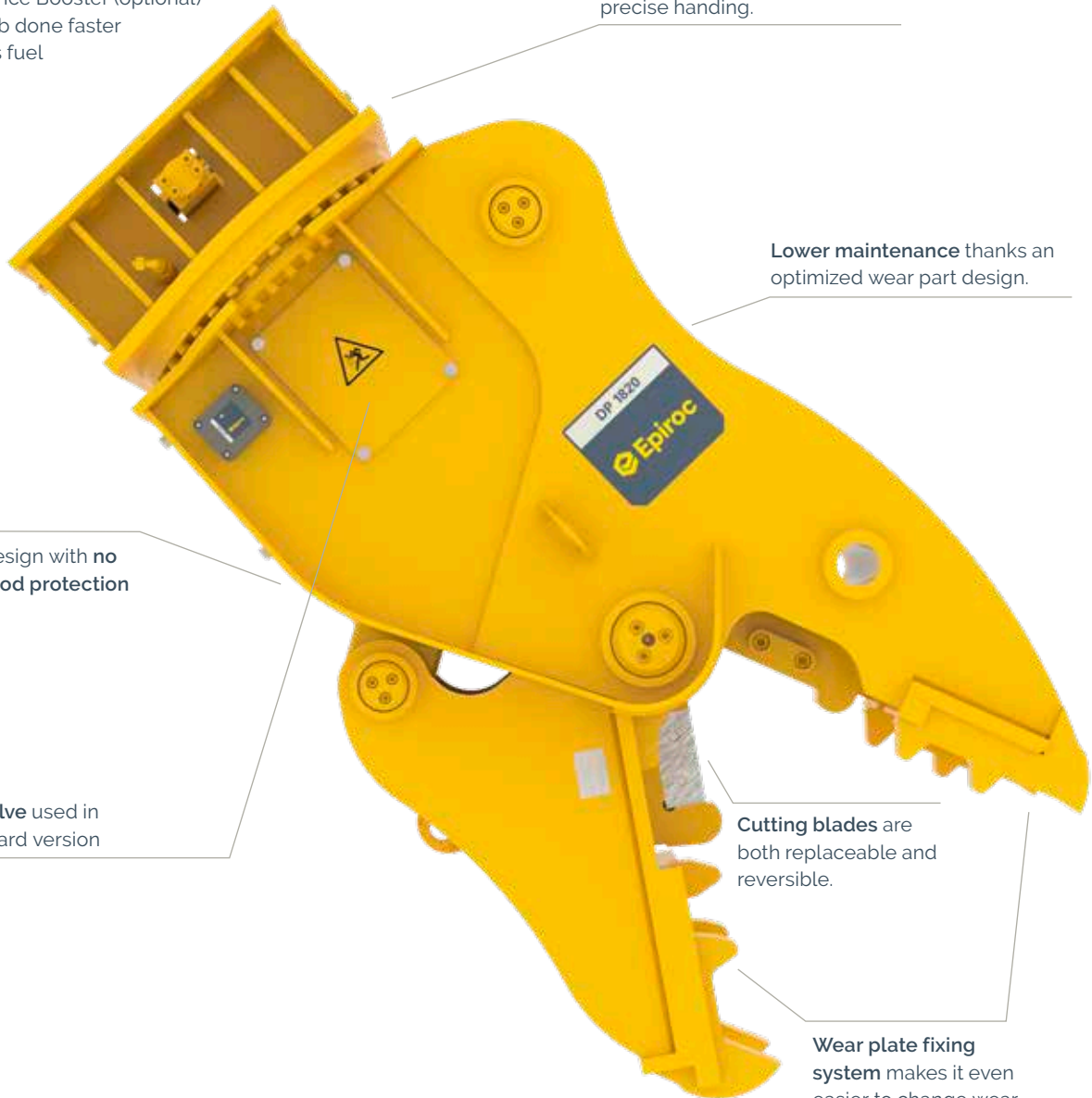

# PERFORMANCE BOOSTER

Key benefits of the optional Performance Booster:

**⊕ Enhanced performance**

The Epiroc Performance Booster elevates the DP 1820's performance by up to an impressive 20%, ensuring jobs are completed faster and more efficiently.

**⊕ Reduced jaw cycle time**

The Performance Booster not only boosts power but also minimizes jaw cycle time by up to 25%, contributing to increased productivity on the job site.

**⊕ Fuel efficiency**

Expect a significant reduction in carrier fuel consumption up to 35%, making the DP 1820 with Performance Booster a sustainable and cost-effective solution.

The Performance Booster can be retrofitted onto existing attachments, a distinctive feature made possible by the robustness of the standard Epiroc pulverizer body.



Long-term use is guaranteed by the extremely robust design of the Demolition Pulverizers. Wear parts are also easily replaced on-site.

DP range		DP 1820	DP 2000	DP 2800
Carrier weight class <sup>1</sup>	t	15-22	18-27	25-35
Service weight <sup>2</sup>	kg	1.820	2.250	2.990
Weight without adapter	kg	1.650	2.050	2.780
A	mm	2.187	2.320	2.550
B	mm	746	780	965
C	mm	720	650	930
D	mm	190	190	350
X	mm	260	340	345
Y	mm	400	460	480
Operating pressure	bar	350	350	350
Oil flow	L/min	140-200	150-250	250-350
Max. operating pressure, rotation	bar	170	170	170
Oil flow, rotation	L/min	35-50	35-50	35-50
<b>Standard version</b>				
F1	t	227	265	320
F2	t	71	85	100
Closing cycle <sup>3</sup>	sec.	16	2.0	19
Opening cycle <sup>3</sup>	sec.	18	19	2.2
<b>With Performance Booster</b>				
F1	t	274	-	-
F2	t	86	-	-
Closing cycle <sup>3</sup>	sec.	2.0	-	-
Opening cycle <sup>3</sup>	sec.	1.1	-	-

<sup>1</sup> Weight apply to standard carriers only. Any variations must be agreed with Epiroc and/or the carrier manufacturer.

<sup>2</sup> Pulverizer with medium - sized adapter. <sup>3</sup> With max Oil flow.

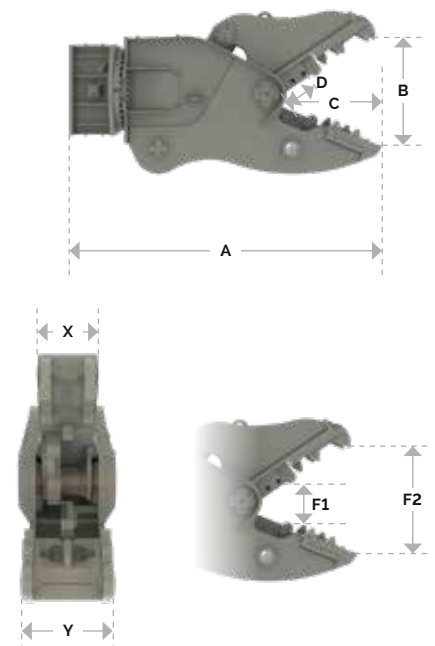

# A versatile shape-shifter

The cleverly-angled Bulk Pulverizers efficiently separate rebar from concrete in the secondary reduction stage.

Full hydraulic cylinder protection thanks to the piston rod guard.

**Tooth plate** is replaceable for easy maintenance.

**Cutting blades** are both replaceable and reversible.

Faster working cycles thanks to the integrated speed valve.

Optional 360° endless hydraulic rotation allows optimal positioning and precise handling.

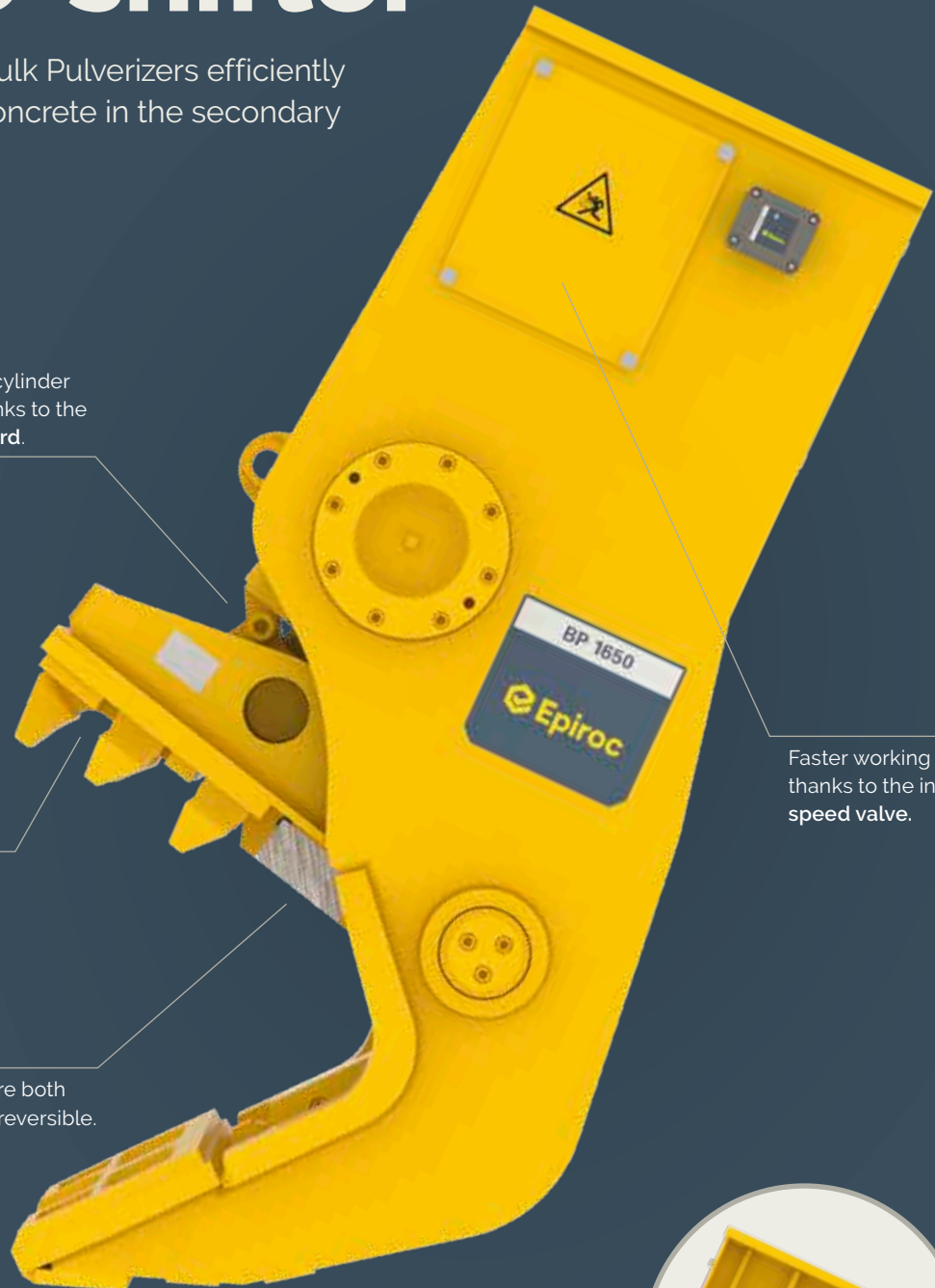

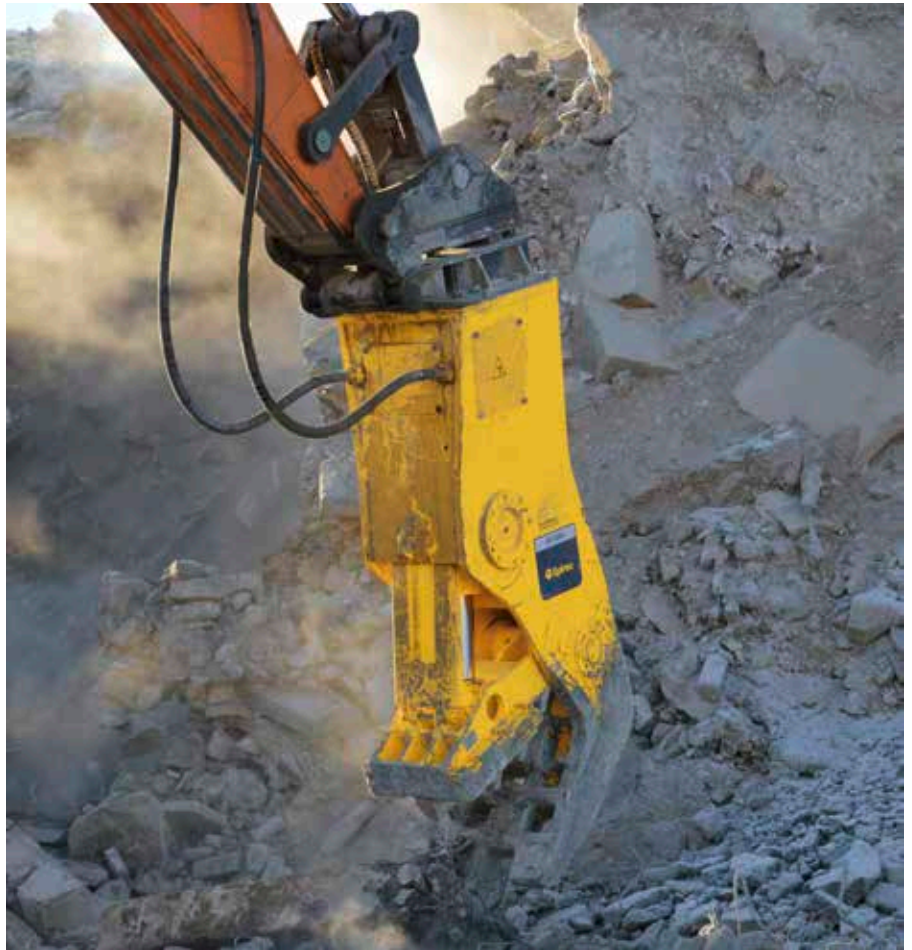

## BP range

		BP 1650	BP 2050	BP 3050	BP 4050
<b>Static version</b>					
Carrier weight class <sup>1</sup>	t	14-23	18-27	25-40	40-55
Service weight <sup>2</sup>	kg	1,770	2,130	3,100	4,550
Product weight	kg	1,600	1,930	2,840	4,100
A	mm	2,100	2,240	2,645	2,980
B	mm	760	875	1,020	1,200
C	mm	550	610	650	800
D	mm	175	190	190	240
X	mm	400	430	590	680
Y	mm	520	550	650	725
<b>Rotating version</b>					
Carrier weight class <sup>1</sup>	t	18-23	22-27	30-40	43-55
Service weight <sup>2</sup>	kg	2,140	2,660	3,850	5,390
Product weight	kg	1,970	2,420	3,500	4,940
A	mm	2,520	2,630	2,990	3,395
B	mm	760	875	1,020	1,200
C	mm	550	610	650	800
D	mm	175	190	190	240
X	mm	400	430	590	680
Y	mm	520	550	650	725
<b>Static and rotating version</b>					
F1	t	210	290	365	310
F2	t	74	90	115	131
Cycle time (opening/closing)	sec	2.0/1.9	2.9/2.5	2.9/2.7	3.1/3.3
Oil flow rate (opening & closing)	L/min	150-250	150-250	250-350	300-400
Max. operating pressure (opening & closing)	bar	350	350	350	350
Oil flow rate (rotation)	L/min	35-50	35-50	35-50	35-50
Max. operating pressure (rotation)	bar	170	170	170	170

<sup>1</sup> Weights apply to standard carriers only. Any variances must be agreed with Epiroc and/or the carrier manufacturer prior to attachment.

<sup>2</sup> Attachment with average-sized adapter plate

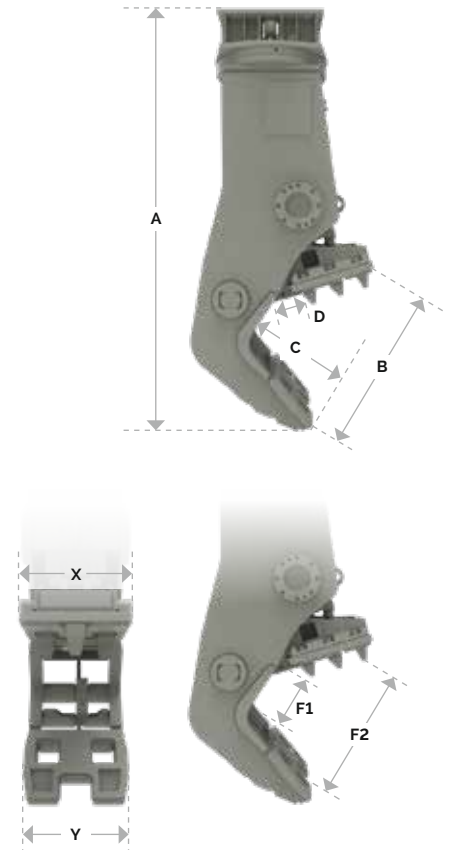

# Turn up the volume

Our Multi Grapples are ideal for loading and sorting various materials as well as demolishing wooden and masonry structures.

Removable **rotation unit** to allow proper use with tiltrotators (MG 1000).

360° endless **hydraulic rotation** allows optimal positioning and precise handling.

Integrated **mechanical stop** to reduce load on cylinders.

Solid **perforated shells** provide excellent visibility during operations.

Optional **tooth blades** for block and stone handling (MG 400–2300).

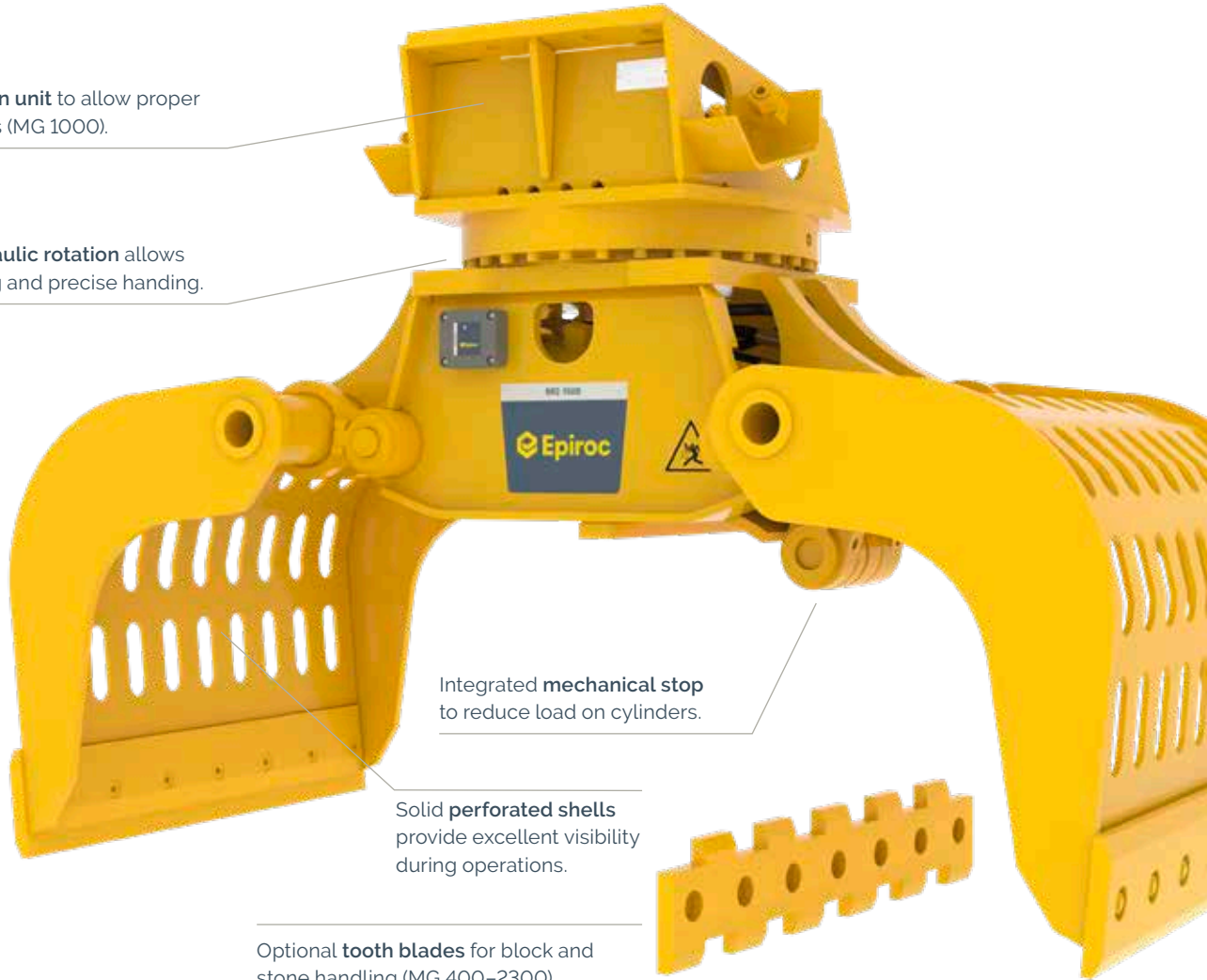

## MG range

		MG 100	MG 200	MG 300	MG 400	MG 500	MG 800	MG 1000
Carrier weight class <sup>1</sup>	t	0.7–1.8	1.2–4	2–6	4–8	5–10	10–16	12–20
Service weight (rotating version) <sup>2</sup>	kg	108	216	324	516	588	985	1,214
Product weight (rotating version)	kg	90	180	270	430	490	821	1,014
Product weight (static version)	kg	–	–	–	375	400	698	905
<b>A</b>	mm	600	651	750	892	892	1,130	1,275
<b>B</b>	mm	580	841	1,157	1,480	1,585	1,747	1,900
<b>C</b>	mm	312	450	500	603	705	800	810
<b>D</b>	mm	–	–	–	755	755	842	991
<b>F1</b>	t	0.6	1.5	2.0	2.3	2.4	3.8	4.6
Loading volume	m <sup>3</sup>	0.02	0.05	0.11	0.21	0.25	0.35	0.49
Oil flow rate (opening & closing)	l/min	15	25	35	40	35–50	70–100	85–120
Max. operating pressure (opening & closing)	bar	300	300	300	300	300	350	350
Oil flow rate (rotation)	l/min	3–5	5–10	5–10	10–15	10–15	20–25	20–25
Max. operating pressure (rotation)	bar	170	170	170	170	170	170	170



Our Multi Grapples handle any material with utmost precision. They deliver a steady grip and virtually constant closing force.

Cutting blades are both replaceable and reversible.

Optional bolt-on side plates for handling fine-grained material and debris (MG 400-1500).



Possible to switch from rotation to non-rotation or converse.

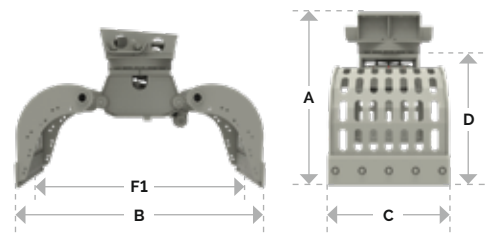

## MG range

		MG 1500	MG 1800	MG 2300	MG 2700	MG 3000	MG 5000
Carrier weight class <sup>1</sup>	t	16-24	20-28	25-38	28-50	35-50	45-100
Service weight (rotating version) <sup>2</sup>	kg	1,776	1,965	2,496	3,045	3,265	5,700
Product weight (rotating version)	kg	1,480	1,633	2,080	2,538	3,000	5,000
Product weight (static version)	kg	1,336	-	-	-	-	-
<b>A</b>	mm	1,478	1,478	1,448	1,651	1,800	2,000
<b>B</b>	mm	2,014	2,014	2,255	2,246	2,460	3,000
<b>C</b>	mm	1,030	1,210	1,210	1,220	1,500	1,500
<b>D</b>	mm	1,130	-	-	-	-	-
<b>F1</b>	t	6.8	6.8	8.0	9.0	9.0	13.0
Loading volume	m <sup>3</sup>	0.73	0.86	0.88	0.92	1.30	1.60
Oil flow rate (opening & closing)	l/min	120-170	150-170	160-180	180-200	180-200	280-300
Max. operating pressure (opening & closing)	bar	350	350	350	350	350	350
Oil flow rate (rotation)	l/min	30-35	30-35	30-35	30-35	30-35	50-60
Max. operating pressure (rotation)	bar	170	170	170	170	210	210

<sup>1</sup> Weights apply to standard carriers only. Any variances must be agreed with Epiroc and/or the carrier manufacturer prior to attachment.

<sup>2</sup> Attachment with average-sized adapter plate

# Cut to the chase

Steel Cutters are ideal for cutting steel structures at demolition sites or recycling metal girders, sheets and cables at scrap yards.





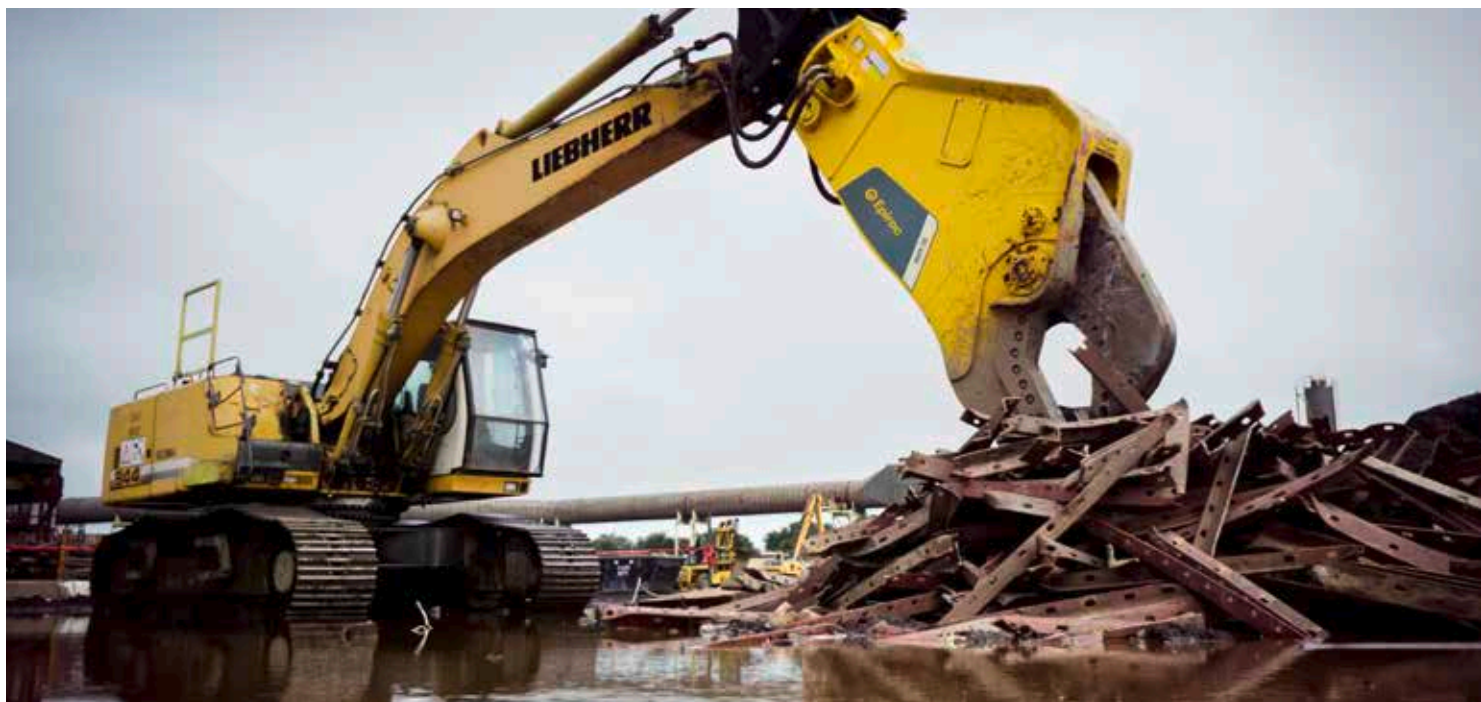

By forcing the material to where the cutter exerts the greatest force, the optimally-shaped jaw cuts through steel easily, no matter the size.

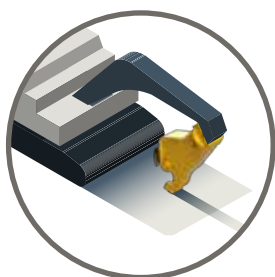

Boom-mounted  
2nd member

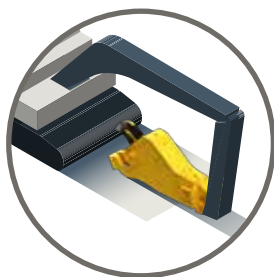

Stick-mounted  
3rd member

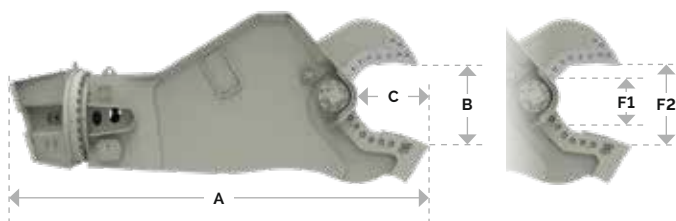

SC range		SC 270	SC 600	SC 2500	SC 3600	SC 4500 <sup>3</sup>	SC 6200 <sup>3</sup>	SC 8300 <sup>3</sup>
Carrier weight class – boom mounted <sup>1</sup>	t	2-4	4-6	16-30	20-38	25-55	30-55	45-65
Carrier weight class – stick mounted <sup>1</sup>	t	4-6	6-9	21-35	32-50	38-60	50-75	65-110
<b>Static version</b>								
Service weight <sup>2</sup>	kg	-	-	2,550	3,830	4,480	6,460	8,310
Product weight	kg	-	-	2,300	3,390	4,037	5,780	7,500
<b>A</b>	mm	-	-	2,235	2,880	3,220	3,555	4,230
<b>B</b>	mm	-	-	445	607	750	782	947
<b>C</b>	mm	-	-	416	544	625	701	903
<b>Rotating version</b>								
Service weight <sup>2</sup>	kg	380	650	2,750	4,030	4,880	6,860	9,060
Product weight	kg	340	570	2,500	3,590	4,440	6,180	8,250
<b>A</b>	mm	1,350	1,900	2,596	3,106	3,568	3,903	4,730
<b>B</b>	mm	195	290	445	607	750	782	947
<b>C</b>	mm	200	290	416	544	625	701	903
<b>Static and rotating version</b>								
<b>F1</b>	t	102	138	532	664	813	955	1,338
<b>F2</b>	t	36	46	130	156	168	201	242
Cycle time (opening/closing)	sec	2.0/2.8	1.8/2.4	2.9/3.1	2.8/2.2	3.6/2.9	5.3/3.5	4.9/3.2
Oil flow rate (opening & closing)	L/min	100	120	240	450	450	450	750
Max. operating pressure (opening & closing)	bar	250	300	350	350	350	350	350
Oil flow rate (rotation)	L/min	15	20	50	50	50	50	50
Max. operating pressure (rotation)	bar	100	100	170	170	170	170	170

<sup>1</sup> Weights apply to standard carriers only. Any variances must be agreed with Epiroc and/or the carrier manufacturer prior to attachment.

<sup>2</sup> Attachment with average-sized adapter plate

<sup>3</sup> Drainage line required

# Waste no time

Hydro Magnets are the best way to pick up valuable scrap metal on-site and turn it into profit. They also protect the workforce and equipment by keeping the ground clear and safe.



Magnetization can be operated either hydraulically or electrically by **radio remote control**.

Integrated **LED status display** allows constant monitoring of the operating conditions.



**Fixed magnet plate** for demolition and construction sites and **movable magnet plate** with chain connector for mass loading at scrap yards.



Built-in generator with advanced control technology provides faster material pick-up by a quick magnetization with impulse excitation and material release by automatic demagnetization with counter voltage and sequence pulsation.

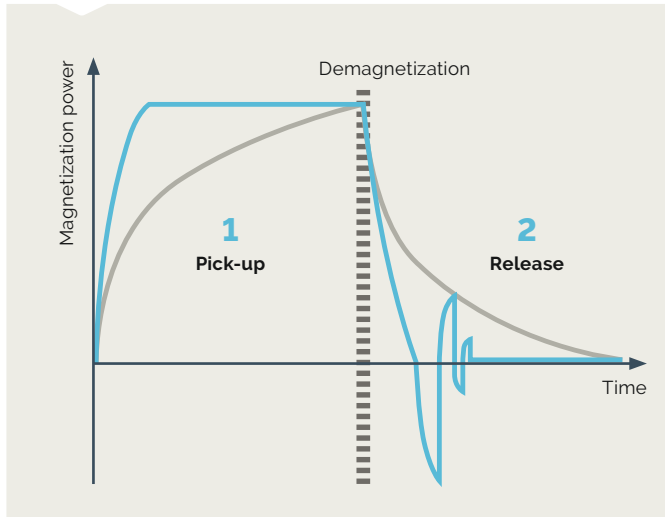

Easy installation makes the Hydro Magnets ideal for demolition sites, scrap yards and recycling facilities.

### HM range

		HM 1500 <sup>3</sup>	HM 2000 <sup>3</sup>
Carrier weight class <sup>1</sup>	t	12-30	15-45
Service weight <sup>2</sup>	kg	1,550	2,000
Product weight	kg	1,360	1,650
<b>A</b> (Fixed/movable version)	mm	1,025/1,580	1,050/1,605
<b>B</b>	mm	280	305
<b>C</b>	mm	1,060	1,250
Generator power	kW	13	13
Magnet power	kW	6	9
Tearing force	t	11.5	15.0
Maximum load	t	5.8	7.5
Oil flow rate (generator activation)	L/min	90-250	90-250
Max. operating pressure (generator activation)	bar	350	350
Oil flow rate (magnet plate activation)	L/min	20	20
Max. operating pressure (magnet plate activation)	bar	50	50

<sup>1</sup> Weights apply to standard carriers only. Any variances must be agreed with Epiroc and/or the carrier manufacturer prior to attachment.

<sup>2</sup> Attachment with average-sized adapter plate

<sup>3</sup> Drainage line required

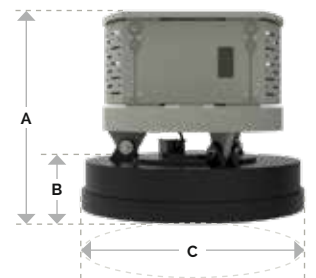

# A crush at work

Our Bucket Crushers make easy work of concrete debris, rubble, masonry, asphalt, natural stone and rock by crushing the material on site.

The internal **timing belt transmission**, driven by **two powerful hydraulic motors**, has a narrower design and enables a reversible running direction to remove jammed material.

**Quick grain size adjustment** without special tools thanks to an intuitive system.

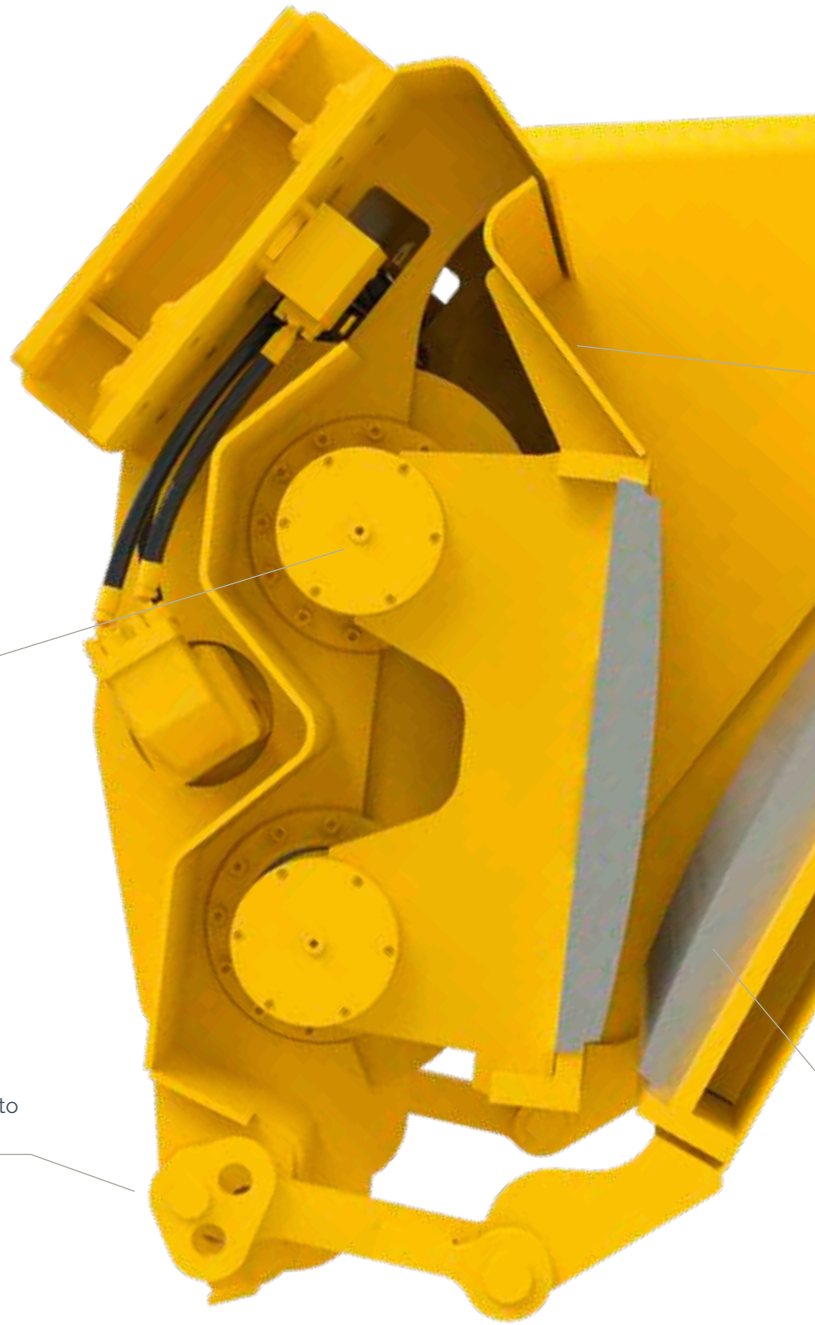

**BC 2100**  
Grain sizes 20/40/60/90 mm



**BC 2500/BC 3700/BC 5300**  
Grain sizes 20/45/70/95/125/150 mm



To increase throughput, a **moving sliding plate** continuously guides material to the crushing jaw.

**Crushing jaw plates** can be easily replaced on-site.



Our Bucket Crushers combine low maintenance and high performance. On-site crushing also means less transportation and dumpsite costs.

<b>BC range</b>		<b>BC 2100<sup>3</sup></b>	<b>BC 2500<sup>3</sup></b>	<b>BC 3700<sup>3</sup></b>	<b>BC 5300<sup>3</sup></b>
Carrier weight class <sup>1</sup>	t	18–28	22–30	28–38	35–54
Service weight <sup>2</sup>	kg	2.250	2.870	4.290	6.050
Product weight	kg	2.120	2.670	4.000	5.700
<b>A</b>	mm	2.046	2.465	2.575	2.829
<b>B</b>	mm	1.311	1.500	1.600	1.700
<b>C</b>	mm	930	900	1.076	1.285
<b>D</b>	mm	400	420	420	465
<b>E</b>	mm	730	730	900	1.100
Loading volume	m <sup>3</sup>	0.5	0.8	1.0	1.2
Oil flow rate	l/min	140–160	160–180	180–200	300
Max. operating pressure	bar	250	250	250	320

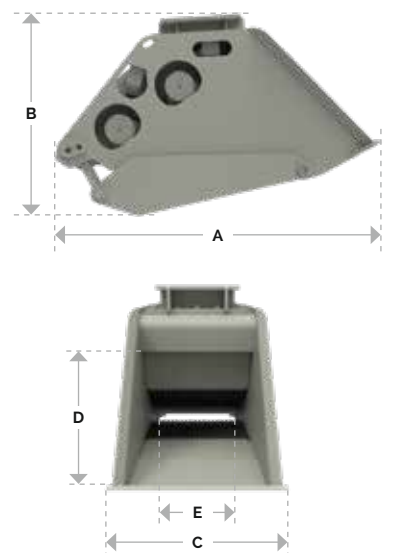

<sup>1</sup> Weights apply to standard carriers only. Any variances must be agreed with Epiroc and/or the carrier manufacturer prior to attachment.

<sup>2</sup> Attachment with average-sized adapter plate

<sup>3</sup> Drainage line required

# Sort it out on-site

Sort and separate rocks, crushed concrete and recycling material with speed and precision using our high-performance Bucket Screeners.

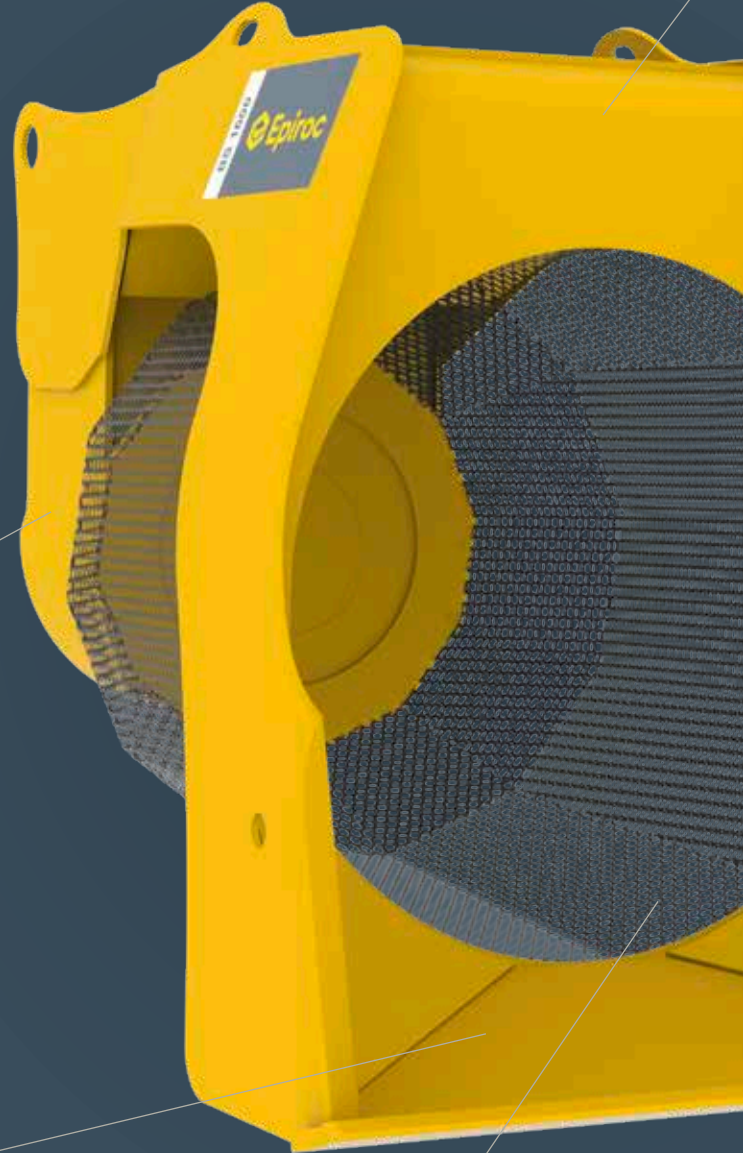

The internal **timing belt transmission**, driven by a powerful hydraulic motor, allows the use of a **large main roller bearing** and optimizes productivity.

The **large hopper capacity** enables maximum intake and thus a constant feeding with material.

Extra large **dodecagonal baskets** and **hexagonal profile of the screening mesh** enables efficient material screening.

The use of special wear resistant steel guarantees highest durability even under the harshest conditions

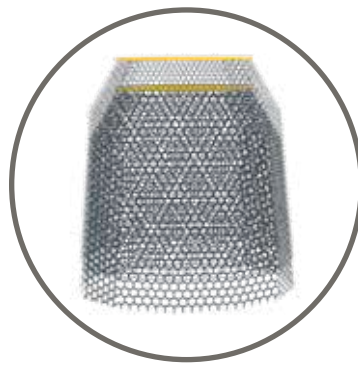
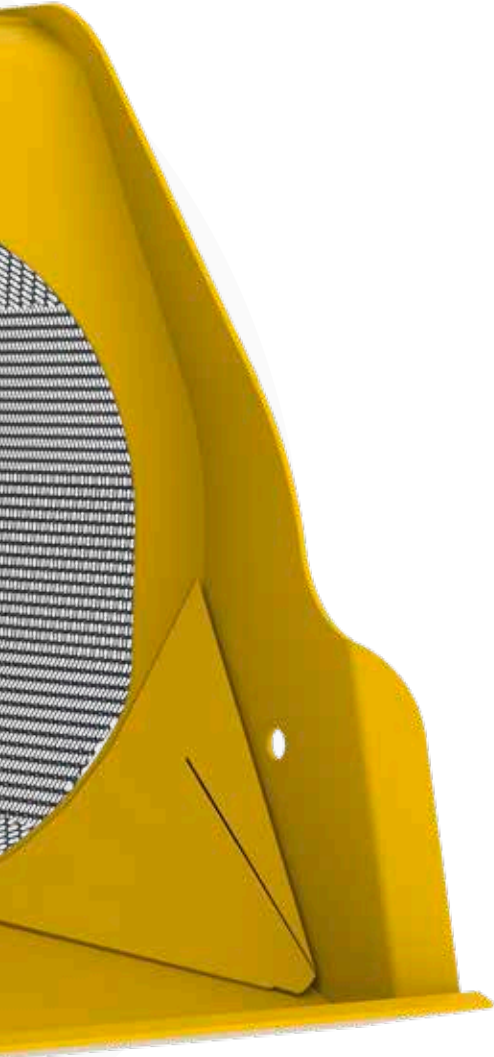

Stackable screening baskets with different mesh sizes: 20/30/40/50/60 and 80 mm

**BS range**

		BS 1600	BS 2200
Carrier weight class <sup>1</sup>	t	18–25	24–38
Service weight <sup>2</sup>	kg	1.710	2.450
Product weight	kg	1.550	2.200
<b>A</b>	mm	2.500	2.800
<b>B</b>	mm	1.700	2.000
<b>C</b>	mm	1.610	1.890
<b>D</b>	mm	1.300	1.600
<b>E</b>	mm	1.230	1.425
Loading volume	m <sup>3</sup>	1.5	3
Oil flow rate	l/min	160–180	180–200
Max. operating pressure	bar	200	250

<sup>1</sup> Weights apply to standard carriers only. Any variances must be agreed with Epiroc and/or the carrier manufacturer prior to attachment.

<sup>2</sup> Attachment with average-sized adapter plate

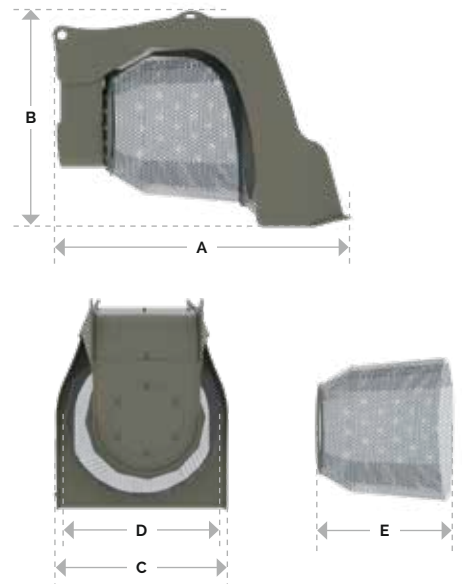

Our consumables and wear parts are the right choice when maximum output and low lifecycle cost are in focus of your daily work.



You can find our consumables catalog for hydraulic breakers here.



You can find our consumables catalog for silent deconstruction tools and drum cutters here.

-  [facebook.com/epirocdemolition](https://facebook.com/epirocdemolition)
-  [facebook.com/epirocgroup](https://facebook.com/epirocgroup)
-  [twitter.com/epirocgroup](https://twitter.com/epirocgroup)
-  [instagram.com/epiroc.demolition.recycling](https://instagram.com/epiroc.demolition.recycling)
-  [linkedin.com/company/epiroc](https://linkedin.com/company/epiroc)

## United in performance. Inspired by innovation.

Performance unites us, innovation inspires us, and commitment drives us to keep moving forward. Count on Epiroc to deliver the solutions you need to succeed today and the technology to lead tomorrow.

**[epiroc.com](https://epiroc.com)**

