



Meteor Loader Blower with Power Pack
Operator's / Parts Manual



MK Martin Enterprise Inc.
3950 Steffler Rd Elmira, ON, Canada N3B 2Z3

Tel: 519-664-2752
Toll Free: 1-855-664-2752
Fax: 519-664-3695
E-mail: sales@mkmartin.ca
www.mkmartin.ca



REV: 17-6

Intentionally Left Blank

Table of Contents

• Warranty	-----	2
• Registration	-----	3-4
• Safety	-----	5-7
• Decal Location	-----	8
• Assembling	-----	9
• Attaching	-----	10
• Electrical Installation	-----	11
• Operating	-----	12
• Sign Off sheet	-----	13
• Power Pack Parts	-----	14-15
• Blower Parts	-----	16-17
• Blower Hydraulic	-----	18
• Hydraulic Deflector	-----	19
• Electric Wiring Diagrams	-----	20-21
• Attachment Plates	-----	22
• Bolt Torque Chart	-----	23
• Maintenance	-----	24

Warranty and Limitations of Liability

All equipment is sold subject to mutual agreement that it is warranted by M K Martin Inc. (Hereafter called the company) to be free of any defects in material and workmanship. The company shall not be liable for special, indirect or consequential damage of any kind under this contract or otherwise. The company's liability shall be limited exclusively to replacement or repair without charge at it's factory or elsewhere, at it's discretion, any materials or defects, which become apparent within one year from the date of purchase. In no event shall M K Martin Enterprise Inc. be liable for special, direct or incidental or consequential damages of any kind. The purchaser by acceptance of the equipment will assume all liability for damage which may result from use or misuse by the operator. The purchaser shall maintain and service the equipment as recommended in the Operator's Manual.

This warranty does not cover **Rental/Commercial or Industrial** use of the equipment. This equipment is rated as agricultural.

For **Rental/Commercial or Industrial** use, Warranty is for defective material and workmanship for a period of 90 days from the date of purchase.

Warranty is null and void unless the Warranty Registration form has been completed and on file at

M K Martin Enterprise Inc
3950 Steffler Rd
Elmira On Ca N3B 2Z3

For your Record

Purchase Date _____

Model # _____

Serial # _____

Please contact your retailer

Manufactured by
M K Martin Enterprise Inc
3950 Steffler Rd
Elmira On Ca N3B 2Z3
Tel: (519)-664-2752
(855)-664-2752
Fax: (519)-664-3695
E-mail: sales@mkmartin.ca

www.mkmartin.ca

**M K Martin Enterprise Inc
3950 Steffler Rd
Elmira ON CA N3B 2Z3**

Purchaser's warranty protection is valid only when this completed form or a copy of this form is on file at M K Martin Enterprise Inc. By filling out this form the purchaser has acknowledged delivery of equipment and owner's / operator's manual and has accepted the condition of the equipment.

Date of delivery to purchaser -----

Type of Equipment -----

Model # ----- **Serial #** -----

Retailer's Signature Indicates

- *Equipment was properly assembled as directed by manufacturer*
- *Equipment was tested for functionality and operates properly*
- *Purchaser was instructed in safe and proper operating procedures*
- *Warranty was explained to purchaser*
- *Purchaser was given the operators manual*

Retailer

Signature -----

Company -----

Address -----

Purchaser's signature indicates

- *Acceptance of equipment fully assembled*
- *Received operator's manual*
- *Clearly understands conditions of warranty*
- *Received instructions of safe and proper operation of equipment*

Purchaser

Signature -----

Company -----

Mailing address -----

City ----- **Prov/State** ----- **Postal Code/Zip** -----

Available phone number -----

Warranty is valid only when it has been received by manufacturer at address above

Warranty Registration

Please Cut and Return to M K Martin Enterprise Inc

Fold And Tape here

Do not tape all edges or use staples

Fold Here

**Postage
Stamp**

**M K Martin Enterprise Inc
3950 Steffler Rd
Elmira ON CA N3B 2Z3**

Safety

Take Note: This safety symbol is found throughout this manual to call your Attention to instructions involving yourself and others working around the machine.

- **Failure to follow these instructions can result in Injury or death**



This Symbol means

- **Attention!**
- **Become Alert!**
- **Your Safety is Involved!**

Signal words are used in this manual.

Caution: Indicates a potentially hazardous situation that may result in injury.

Warning: Indicates a hazardous situation that could result in serious injury or death.

Danger: Indicates a hazardous situation that needs to be avoided. It is you the operator that needs to be aware of these dangers!

If you have any questions not covered in this manual please contact your dealer or;

M K Martin Enterprise Inc.
3950 Steffler Rd
Elmira On Ca N3B 2Z3

Tel: 519-664-2752
1-855-664-2752
Fax: 519-664-3695
e-mail: sales@mkmartin.ca
www.mkmartin.ca



Safety --- It's in your interest!



Safety Guidelines

Safety of operation is one of our main concerns, however it is up to the operator to practice caution!

To avoid personal injury, study the following precautions and insist that all those working with you follow them as well.

The Meteor Snowblower has a shield covering the auger motor and the hydraulic lines leading to the motor. Do not use with cover loose or missing.

Replace any decals that maybe missing or not readable. Location of decals are indicated elsewhere in this manual.

Do not use this machine while under the influence of drugs or alcohol.

This equipment should not be operated by children: or those unfamiliar with the operation of the Meteor Snowblower. **Do not allow persons to operate this machine until they have read this manual and/or where instructed by a qualified person.**

Do not use this machine to push snow as this can result in the augers Becoming broken or bent.



When removing ice and snow from the machine; **Stop the engine and remove the keys on the Loader and disconnect the chute control wire!** This will reduce the possibility of the blower being started and causing personal injury.



Please be careful with the extra weight on the tractor. Note: you have added weight to the front and back of the tractor. Keep the blower close to the ground at all times. Do not drive with the loader raised up more than a few feet.

Hydraulic Leak Test



Warning! Do not check for high pressure leaks with your hands or fingers. Use a piece of cardboard or a thin piece of wood to detect the leak.

A high pressure stream of fluid from a pin hole can penetrate the skin and inject hydraulic fluid into your blood veins.

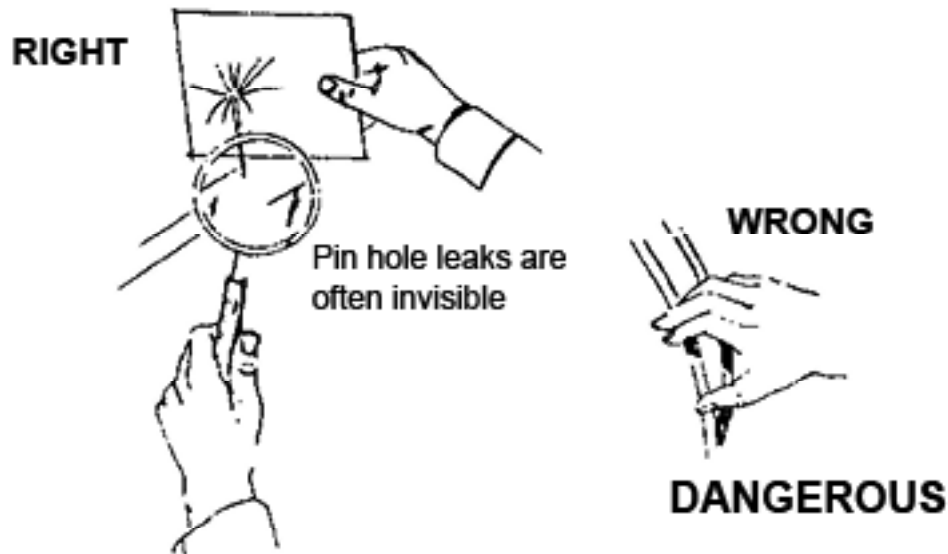

Figure 1. Detecting pinhole leaks in a hydraulic system.



IF THE SKIN HAS BEEN PENETRATED GET MEDICAL ATTENTION IMMEDIATELY!



Hydraulic lines may have high pressure fluid in the lines, even when the lines are disconnected.

Remember a small leak at high pressure may be invisible yet can penetrate the skin. If this happens get medical attention immediately, serious infection or toxic reaction can develop when hydraulic fluid pierces the skin.

Use caution when working with hydraulic components. Ensure there are no leaks, all fittings are tight and all components are in good repair.











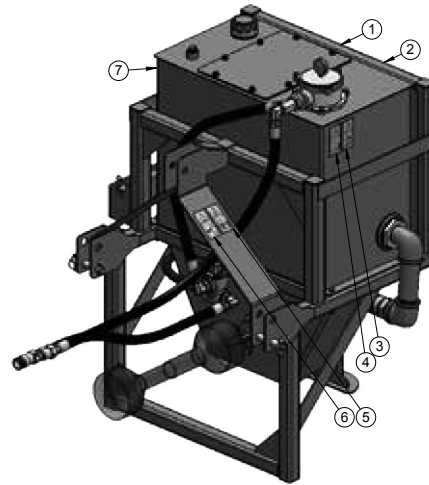
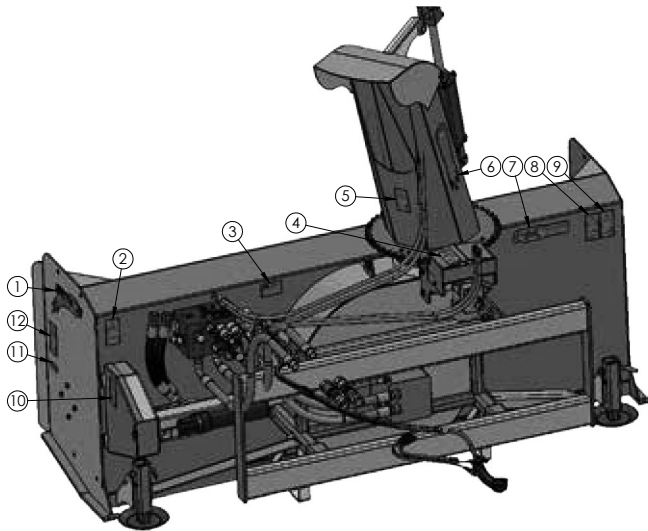



Use a piece of wood or cardboard as a backstop when searching for leaks, **NEVER** your hand or fingers.









Always relieve pressure before disconnecting or working on hydraulic system.

Meteor Loader Blower Decal Location



Meteor Loader Blower Decals	
	1- Meteor small decal 2 pieces
	2- 244 Avoid fluid escaping under pressure. Consult technical manual for service procedures. 1 piece
	3- Serial number plate 1 piece
	4- 213 Do not open or remove safety shields while engine is running. 1 piece
	5- 224 Keep safe distance from this machine. 1 piece
	6- Chute decal. 2 pieces
	7- SmallMKMartin Made in Canada. 1pc
	8- 226 Shut off engine and remove key before performing maintenance or repair work. 1 piece
	9- F9 Read operators manual 1 piece
	10- 212 Do not open or remove safety shields while engine is running. 1 piece
	11- Grease decal. 2 pieces
	12- 236 Stay clear of rotating auger 2 pieces

Power Pack Decals	
	1- SmallMKMartin Made in Canada 1 piece
	2- Decal SMV, slow moving vehicle. 1 piece
	3- 226 Shut off engine and remove key before performing maintenance work. 1 piece
	4- F9 Read operators manual 1 piece
	5- 207 Stay clear of draft link lifting range while operating rockshaft controls. 1 piece
	6- 220 Do not open or remove safety shields while engine is running. 1 piece
	7- 244 Avoid fluid escaping under pressure. Consult manual for service procedures. 1 piece



Attaching the Meteor Loader Blower

The Loader Blower has two basic parts. The Power Pack and the Blower. The Power Pack is attached on the rear 3ph and driven with the PTO. The Blower is attached to the loader and driven with hydraulic lines from the power pack.

The Power Pack and the power Pack lines use Flat Face Couplers and the line that is attached to the loader arms have Flat Face couplers at each end. The hoses that are routed along the loader arms need to be positioned so they won't get pinched, kinked, stretched or get caught at any point during the movement of the loader arms, tilting forward and back. The hoses to the power Pack also need to be positioned so they will not interfere.

Attach the Power Pack to the 3ph in the same manner as an implement is attached. Adjust the top link to level the reservoir in the working position. After the Pack is on the tractor, put the back stand in the transport position.

Attach the Blower the same as any loader attachment. Ensure that all pins are locked and secure.

The Chute Rotator and Deflector are operated by 12 volt electrics from the battery and controlled by the operator. The electric control consists of a Battery wire, a Control Handle, an Extension wire and wire leads on the Blower.

The Battery wire should be attached to the Battery or a 25 amp source of power. The Battery wire is connected to the Control Handle, the Extension wire is plugged into the other Handle plug and strung along the Hydraulic lines to the Blower. The Battery wire has a 20 amp breaker inside to protect the wires and the Valve Block.

Operating the Meteor Loader Blower

Before operating this equipment, inspect all electrical connections and hydraulic couplings for proper connection.

Raise the Power Pack far enough to have adequate ground clearance of the front stand. Place the back stand in transport position to keep it from getting damaged.

To start the Blower idle the engine down and engage the PTO, slowly bring the engine to 540 PTO speed. This will also start the Blower motors. There is no on/off valve in the system.

There is a relief valve to protect the hydraulics and blower fan and auger.



Please note that there is added weight to both ends of the tractor. The Power Pack filled with oil weighs approx 700 lbs and the Blower at 950 lbs for a total of approx 1650 lbs. **Ensure you have proper tire pressure!** The tractor will also handle differentially with the added weight.



Slow down and do not drive with the blower raised too high as this would cause the tractor to become unstable and top-heavy and easier to roll over!



To ensure your safety. Before doing any work on the blower, removing foreign matter, unjamming, adjusting or cleaning off, Stop the tractor engine and remove the key AND unplug the battery wire from the chute control handle! This ensures that the hydraulics or the electrics will not become activated and cause an injury or death.

Sign Off Form

M K Martin Enterprise Inc. follows the general Safety Standards specified by the American Society of Agricultural Engineers (ASAE) and the Occupational Health and Safety Administration (OSHA). Anyone who will be operating and/or maintaining the equipment must read and clearly understand ALL Safety Operating and Maintenance instructions presented in this manual. Do not operate or allow anyone else to operate this equipment until such information has been reviewed. Annually review this information before the season start-up. Make these reviews of SAFETY and OPERATION annually as a standard practice for all your equipment. We feel that an untrained operator is unqualified to operate this machine. A sign-off sheet is provided for your record keeping to show that all personnel who will be working with the equipment have read and understood the information in the operator's manual and have been instructed in the operation of the equipment.

Date	Employees Signature	Employers Signature

Hydraulic Power Pack

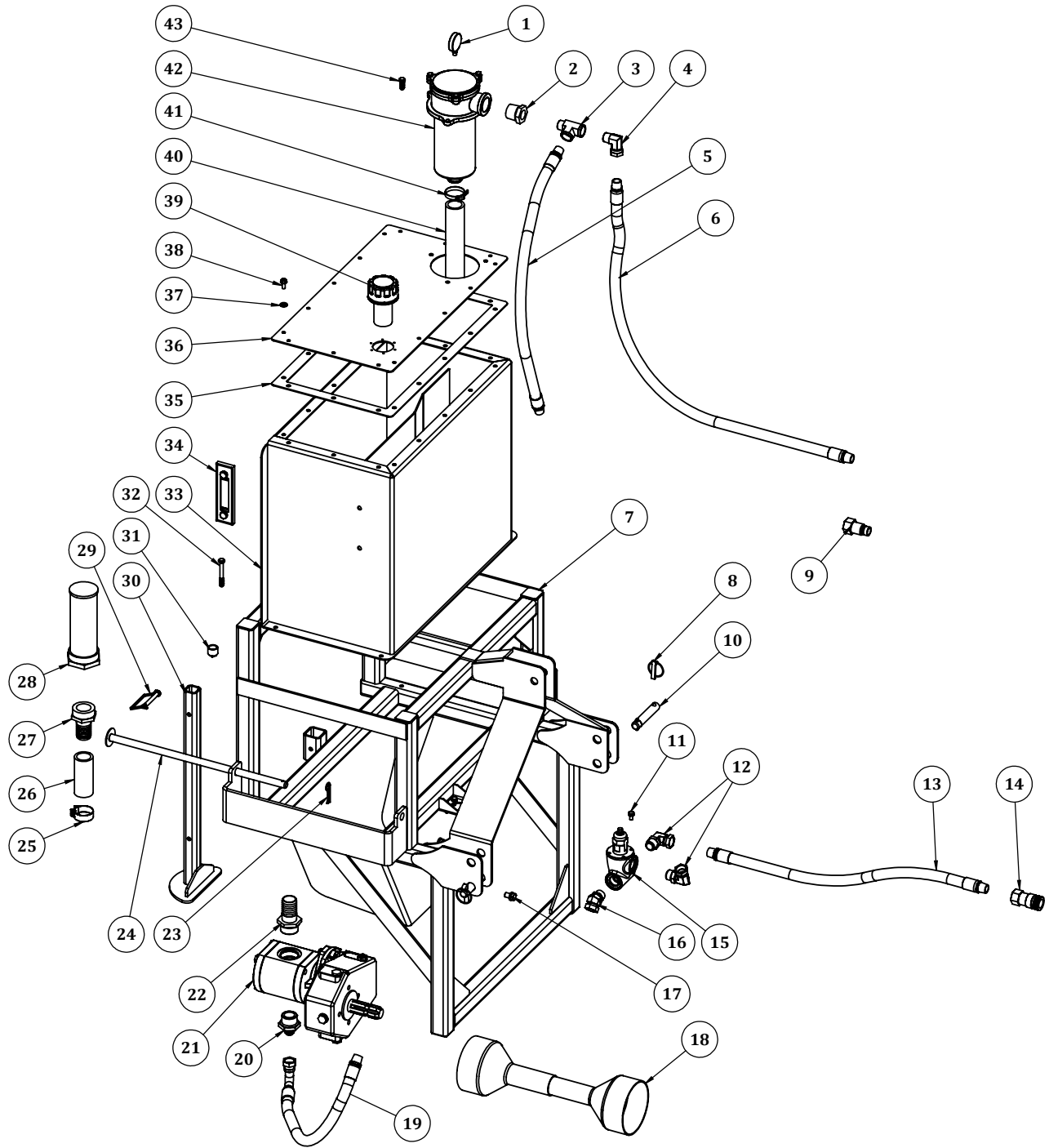

Item #	Part #	Description	Qty
1	H112-M-NA10	Filter Indicator Gauge	1
2	5406-2012	Adapter	1
3	5602-1212	Adapter Tee	1
4	1501-1212	Adapter Elbow	1
5	33626	Relief Valve Return Hose	1
6	33629	Return Hose	1
7	33347	Main Frame	1
8	OL	7/16 Lynch Pin	2

Item #	Part #	Description	Qty
9	FF3-4 Male	Flat Face Coupler	1
10	382710	Hitch Pin	2
11	OL	Bolt 8- 1.25x16 mm Bolt c/w 5/16 lw	4
12	6901-1212	Adapter Elbow	2
13	33627	Main Pressure Hose	1
14	FF3-4 Female	Flat Face Coupler	1
15	VMPK20	Relief Valve	1
16	6902-1212	Adapter 45° Elbow	1
17	OL	M12x1.75x20 Bolt c/w 1/2 lw	4
18	519-871187	PTO Assembly	1
19	33628	Pump to Relief Valve Hose	1
20	6400-1220	Adapter	1
21	23597	Hydraulic Pump c/w Gearbox	1
22	24053	Pump Line in Adapter	1
23	OL	5/32 Hair Pin	2
24	33334	Weight Lock Pin	2
25	52777	Heavy Hose Clamp	2
26	33642	Pump Suction Hose	1
27	24052	Adapter Tank Out	1
28	TMF-50-0	Suction strainer	1
29	OL	3/8 PTO Pin	1
30	33364	Stand	1
31	246-102	Magnetic Plug	1
32	OL	Bolt 3/8x3 c/w lw, n	4
33	33363	Main Reservoir	1
34	HL91-20	Oil Level Gauge	1
35	24082	Gasket	1
36	33399	Main reservoir Top	1
37	52776	5/16 sealing washer	16
38	OL	Bolt 5/16 x 3/4 Hex flange serrated	16
39	706-970-115	Filter Breather	1
40	33643	Drop Hose	1
41	OL	#24 Clamp	1
42	24054	Return-line Filter	1
43	OL	Bolt 3/8x1 c/w lw	3

Bolt Torque As used on this equipment

Bolt torque table shown below gives torque values for the various bolts used. This chart is for non-lubricated threads. Replace with the same strength bolt.

Torque Specifications. Torque values are identified by their head markings

Diameter	SAE 2		SAE 5		SAE 8	
	Lb-ft	N.m	Lb-ft	N.m	Lb-ft	N.m
1/4	6	(8)	9	(12)	12	(17)
5/16	10	(13)	19	(25)	27	(36)
3/8	20	(27)	33	(45)	45	(63)
7/16	30	(41)	53	(72)	75	(100)
1/2	45	(61)	80	(110)	115	(155)
5/8	95	(128)	160	(215)	220	(305)
3/4	165	(225)	290	(390)	400	(540)
1	225	(345)	630	(850)	970	(1320)

Allen head cap screws are similar to SAE 8 quality.

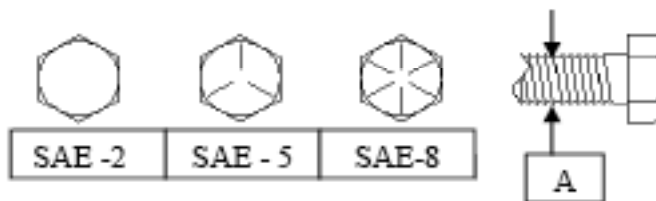

These torques are for a reference only. Not all these sizes and grades are necessarily used in this machine. Bolts that are used as a pivot or hinge have to be used with a locknut, therefore only tighten enough to secure the bolt and still allowing the part to rotate freely.

Maintenance

Daily *(or for each use)*

- Inspect the main hydraulic lines for signs of wear and abrasion.
- Check Oil Level in Reservoir.
- Inspect Hydraulic Couplers for connections.
- Inspect electrical connections.
- Check Auger Drive Chain tension
- Grease PTO joints

Occasionally

Check Filter Indicating Gauge for the condition of the return filter.

Replace element if required.

Annually

- Drain tank into clean container and check inside of tank for signs of rust or moisture.
- Check the magnetic Drain Plug for iron contamination.
- If the inside of tank was contaminated, dispose of the oil in a environmentally safe manner.
- Clean the inside of any loose scale
- Check the Suction screen, clean if necessary.
- Inspect Suction Screen for rips or holes.
- Change Return Line Filter.
- Clean Tank Breather.
- Apply a small bead of silicon gasket on the top tank flange and replace top lid
- Refill with hydraulic oil

Storing

Store in a dry, firm place

Brush oil on auger drive chain

Inspect for loose or worn parts, repair or replace

Hydraulic Oil ----- Kendal 4 Seasons AW32 or equivalent

Hydraulic Return Line Filter Element ----- Ikron SP010 or equivalent

Grease ----- Multi Purpose



MK Martin Enterprise Inc.
3950 Steffler Rd Elmira, ON, Canada N3B 2Z3

Tel: 519-664-2752
Toll Free: 1-855-664-2752
Fax: 519-664-3695
E-mail: sales@mkmartin.ca
www.mkmartin.ca