

OGDEN

RCR812 HAY RUNNER



Owner's Manual

For Hay Rakes after serial #01425



MADE IN USA

Read, Understand, and Follow the information and procedures in this manual to safely operate and maintain the Hay Runner wheel rake.



Contents

1. INTRODUCTION	2		
1.1 Welcome	2		
1.2 Description and Intended Use	2		
1.3 Safe Operation	2		
1.5 Intended Usage	3		
1.6 Operator Orientation	3		
1.7 Product Improvements	3		
1.9 Serial Number Location	4		
2. SAFETY	5		
2.1 General	5		
2.2 Safety Alert Symbol	5		
2.3 Safety Icons Nomenclature	6		
2.4 General Safety Instruction	7		
2.5 Operation Safety	8		
2.6 Transporting Safety	8		
2.7 Storage Safety	8		
2.8 Maintenance Safety	8		
2.9 Training	8		
3. SAFETY SIGNS AND LABELS	10		
3.1 General Information	10		
3.2 Decals	10		
3.3 How to Install Replacement Safety Signs	10		
3.4 Safety Sign Locations	11		
4. ASSEMBLY	14		
4.1 Assembly Area	14		
4.2 Quick Reference Guide	14		
4.3 Tongue Extension	14		
4.4 Attach the Tongue Assembly	15		
4.5 Rake Arm Transport Locks	16		
4.6 Attach Optional Single or Double Wheel Extension	16		
4.7 Hay Rake Wheels	17		
4.8 Adjust Height of Hitch	17		
4.9 Grease the Pivot Pins	17		
4.10 Optional Center Wheel Kit	18		
5. INITIAL SET UP	20		
5.1 Setting Up the Wheel Rake	20		
5.2 Attaching to Tractor	20		
5.3 Purge Air from Hydraulic Lines and Cylinders	20		
5.4 Level the Rake	21		
5.5 Wing Extension Adjustment	21		
5.6 Rake Angle Adjustment (rear center rake wheels)	22		
5.7 Rake Angle Adjustment (front center rake wheels)	22		
5.8 Adjust Rake Wheel Ground Pressure	23		
6. WHEEL RAKE OPERATION	24		
6.1 User Safety	24		
6.2 Hydraulic Requirements	24		
6.3 Using the Wheel Rake	25		
6.4 Detaching From Tractor	27		
7. TRANSPORTING	28		
7.1 Transporting Safety (Road)	28		
7.2 Transporting Procedure	28		
8. STORAGE	29		
8.1 Placing In Storage	29		
9. MAINTENANCE	30		
9.1 General Maintenance Safety	30		
9.2 Work Area	30		
9.3 Parts Replacement	30		
9.4 Hydraulic System Safety	31		
9.5 Welding Repairs	31		
9.6 Wheel Bearings	31		
9.7 Replacing Tines	32		
9.8 Inspection	33		
9.9 Replacing Rake Wheel Tension Spring	34		
10. TROUBLESHOOTING	36		
11. REPLACEMENT PARTS	37		
11.1 Ordering Parts	37		
12. WARRANTY	46		

1. Introduction

1.1 Welcome



RCR812 Hay Runner™ Family of Wheel Rakes

Congratulations on your choice of an Ogden Metalworks, Inc. RCR812 family of wheel rakes. The Hay Runner wheel rake has been engineered and built for ease of operation and long service life.

Many features incorporated into this wheel rake are the result of suggestions made by customers like you. Read this manual carefully to learn how to operate the wheel rake safely and how to set it to provide maximum efficiency.

By following the operating instructions, in conjunction with a good maintenance program, your Ogden Metalworks wheel rake will provide many years of trouble-free service.

1.2 Description and Intended Use

This wheel rake is designed to invert cut hay or other forage crops to allow wet hay on the bottom of the swath to be exposed to sun and wind, to merge swaths together, and to narrow the swath into a windrow of the required width for harvester or baler pick-up. Our family of rakes has eight, ten, or twelve wheels with an optional set of front-mounted kicker wheels to turn the center of the windrow.



1.3 Safe Operation

Safe, efficient, and trouble-free operation of your wheel rake requires that you, and anyone else who will be using or maintaining the unit, read and understand the information contained within this manual and other related OEM equipment manuals.

Store this manual in the Manual Canister on the tongue for future reference.



To prevent personal injury or even death, be sure you read, understand, and follow all of the instructions in this manual and other related OEM equipment manuals! The wheel rake, if not used and maintained properly, can be dangerous to users unfamiliar with its operation. Do not allow operating, maintaining, adjusting, or cleaning of this wheel rake until the user has developed a thorough understanding of the safety precautions and functions of the unit.

This wheel rake is designed for the specific purpose of raking hay and other forage crops. DO NOT modify or use this wheel rake for any application other than that for which it was designed.

Wheel rakes maintained or operated improperly or by untrained personnel can be dangerous; exposing the user and bystanders to severe injury or even death.

1.4 Specifications

DESCRIPTION	RCR 8		RCR 10		RCR 12	
	Minimum	Maximum	Minimum	Maximum	Minimum	Maximum
Raking Width*	17'	22' 6"	19'	22' 6"	21'	26' 6"
Number of Wheels	8		10		12	
Weight in Pounds	1960		2135		2300	
	Minimum			Maximum		
Transport Width**	8'			10' 6"		
Transport Length**	17'			21'		
Transport Height**	9'			11'		
Windrow Width**	3'			6'		
Wheel Hubs & Bearings	Greasable Tapered Roller Bearings					
Wheel Diameter	55" & 60"					
Tine Diameter	7 mm & 7.5 mm					
Number Of Tines Per Wheel	40					
Rake Wheel Suspension	Independent Arm For Each Wheel – Teflon Bushings					
Ground Pressure Adjustment	At Pivot					
Hydraulic Cylinders	Patented Adjustable Torsion Spring On Each Wheel					
Hydraulic Pressure	3" x 12" Double Acting					
Requirement	Minimum 1900 PSI					
Hydraulic Remote Ports Required	One Set					
Tires	205/75-15"					
Hydraulic Center Wheel Kit	Optional					
Walking Tandem Axles	Optional					
Wind Guards	Optional					

* Will vary depending on crop conditions

** Dimensions vary per model

1.5 Intended Usage

Do not use this wheel rake for any other purpose than its intended use of raking hay and other forage crops.

If the wheel rake is used or altered in any way from the original design, the manufacturer does not accept any liability for injury or warranty.

1.6 Operator Orientation

The directions left, right, front, and rear, as mentioned throughout this manual, are as seen from the tractor operator's seat and facing in the direction of travel.

1.7 Product Improvements

Because Ogden Metalworks maintains an ongoing program of product improvement, we reserve the right to make improvements in design or changes in specifications without incurring any obligation to install them on units previously sold.

1.8 Disposal of Equipment at End of Useful Life

The Ogden Metalworks family of wheel rakes have been designed for the specific purpose of raking hay and other forage crops. When this unit is no longer capable of doing its designed purpose, it should be dismantled and scrapped. Do not use any materials or components from this unit for any other purpose.

1.9 Serial Number Location

The hay rake's serial number is located on the center tube of the main frame near the rear of the unit. Please use this number when requesting service, seeking information, or ordering parts. Record the serial number in the space provided for easy reference when contacting Ogden Metalworks with questions.



Serial Number _____

Model Number _____

Purchase Date _____

Dealer _____

Address _____

Phone Number _____

1.10 Owner/Operator Manual Storage

Store the Operator manual and other operating materials in the document storage tube located on the tongue.



1.11 Unanswered Questions

If you have any questions not answered in this manual, require additional copies, or the manual is damaged, please contact your dealer or:

Ogden Metalworks
PO Box 128
301 N. Marilyn Ave.
Ogden, IL 61859

PH: (217) 582-2552
Fax: (217) 582-2746

www.ogdenmetalworks.com
email: ogdenmetalworks@ogdenmetalworks.com

2. Safety

2.1 General

Most work-related accidents are caused by failure to observe basic safety rules or precautions. An accident can often be avoided by recognizing potentially hazardous situations before an accident occurs. As you operate and maintain the wheel rake you must be alert to potential hazards. You should also have the necessary training, skills, and tools to perform any assembly procedure.

Improper operation or maintenance of this unit could cause a dangerous situation that results in injury or death.

Do not use this unit until you read and understand the information contained in this manual. Do not use the wheel rake for anything other than its intended purpose.



Do not use the wheel rake until you read and understand the information contained in this manual.

Safety precautions and warnings are provided in this manual and on the unit. If these hazard warnings are not followed, bodily injury or death could occur to you or other persons.

Ogden Metalworks cannot anticipate every possible circumstance that might involve a potential hazard. The warnings in this manual and on the product are, therefore, not all-inclusive. If a method of operation not specifically recommended by us is used, you must satisfy yourself that it is safe for you and others. You should also ensure that the unit will not be damaged or be made unsafe by the methods that you choose.

The information, specifications, and illustrations in this manual are based on the information that was available at the time this material was written and can change at any time.

2.2 Safety Alert Symbol



This is the safety alert symbol. It is used to alert you to potential personal injury hazards. Obey all safety messages that follow this symbol to avoid possible injury or death.

This manual contains DANGERS, WARNINGS, CAUTIONS, IMPORTANT NOTICES, and NOTES which must be followed to prevent the possibility of improper service, damage to the equipment, personal injury, or death. The following keywords call the readers attention to potential hazards.

Hazards are identified by the “Safety Alert Symbol” and followed by a signal word such as “DANGER”, “WARNING”, or “CAUTION”.



Indicates an imminently hazardous situation which, if not avoided, will result in death or serious injury. This signal word is limited to the most extreme situations.



Indicates a potentially hazardous situation which, if not avoided, could result in death or serious injury.



Indicates a potentially hazardous situation which, if not avoided, may result in minor or moderate injury.



Indicates that equipment or property damage can result if instructions are not followed.



Safety instructions (or equivalent) signs indicate specific safety-related instructions or procedures.

Note: Contains additional information important to a procedure.



2.3 Safety Icons Nomenclature

This manual and the equipment have numerous safety symbols. These safety symbols indicate important information about personal injury hazards.















2.3.1 Personal Protection/Important Information

-  Read the manual
-  Maintenance procedure
-  Eye protection
-  Hand protection
-  Inspect equipment
-  Do not weld
-  Use proper tools
-  Warning decal alert
-  Stop machine engine
-  Check/Maintain Fluid Levels
-  Place in neutral
-  Remove key
-  Stop engine
-  Set parking brake

2.3.2 Prohibited Actions

-  No riders
-  No children

2.3.3 Hazard Avoidance

-  Safety alert symbol
-  Crushing hazard
-  Crushing hazard
-  Falling hazard
-  Fire hazard
-  Hot surface
-  Sharp object hazard
-  High pressure fluid hazard
-  Zero pressure
-  Entanglement hazard
-  Defective or broken part
-  Maintain safe distance
-  Pinch point hazard
-  Pinch point hazard
-  Pinch point hazard
-  Electrocution hazard
-  Tip over hazard

2.4 General Safety Instruction

The owner/operator is responsible for the SAFE use and maintenance of the wheel rake. Make sure anyone who is operating, maintaining, or working around the wheel rake is familiar with the operating and maintenance procedures and related SAFETY information contained in this manual. This manual will take you step-by-step through your working day and alerts you to all good safety practices that should be used while using the wheel rake.

In addition to the design features of the wheel rake, including safety signs, accident prevention is dependent upon the awareness, concern, prudence, and proper training of the people involved in the operation, maintenance, and storage of the wheel rake.

These general safety instructions apply to the overall use and maintenance of the wheel rake.

In addition to this safety section, also refer to safety messages and instructions in each of the appropriate sections of this manual.

More specific instructions on safety are found in the operation, transporting, maintenance, and storage sections of this manual. Refer to these sections before performing any of these tasks.

WARNING Failure to comply with the following safety instructions could result in serious injury and possibly even death if they are not understood and followed.

 **Provide User with Literature**
The wheel rake's owner must provide operator instructions to anyone using the wheel rake before use, and at least annually thereafter. Refer to "2.10 OSHA Training Requirements" on page 8.

 **Stay Clear**
Clear the area of people, especially small children, before using the wheel rake. Under no circumstances should young children be allowed to work with or around the wheel rake.

 **Crush Hazard**
Hydraulic or mechanical failure can allow a wing to drop suddenly without warning. Do not allow anyone to walk under or stand near a raised rake arm.

 **Impaired User Hazard**
Do not attempt to assemble, operate, or maintain this wheel rake under the influence of drugs or alcohol. Consult your doctor before using this wheel rake while taking prescription medications.

 **Fall or Crush Hazard**
Do not allow anyone to ride on the tractor or the wheel rake. Falling or crushing hazards could result in severe injuries or death.

 **No Unauthorized Modifications**
Do not modify the wheel rake or its safety devices. Do not weld on the unit. Unauthorized modifications may affect the unit's function, or create safety hazards.

 **Damaged Parts Hazard**
Do not use the wheel rake if any parts are damaged. If the wheel rake is believed to have a defect which could cause it to work improperly, immediately stop using it and remedy the problem before continuing.

 **Fall Hazard**
Do not use the unit as a work platform. Do not stand on top of the unit at any time. Do not ride on the unit or allow others to ride on it.

CAUTION The following safety instructions are provided to help prevent potential injury. Not following these instructions may lead to injury.

Personal Protection Equipment
When using this wheel rake, wear appropriate personal protective equipment. This list may include, but is not limited to:



- Protective shoes with slip resistant soles
- Protective eyewear
- Protective clothing and gloves
- Hearing protection



Hearing Loss

Prolonged Exposure To Loud Noise May Cause Permanent Hearing Loss!

Working environments with noise-producing equipment can cause partial to permanent hearing loss. We recommend using hearing protection any time noise levels exceed 80 decibels (dB). Noise levels over 85 dB, on a long-term basis, can cause severe hearing loss. Noise levels over 90 dB over a period of time can cause permanent and even total hearing loss. Hearing loss from loud noise is cumulative over a lifetime without hope of natural recovery.



Crush Hazard

The tractor should be equipped with a Roll Over Protective Structure (ROPS) and a seat belt. A crushing hazard may occur if the driver is ejected from the seat while the tractor is in motion. Fasten the seat belt whenever the tractor is moving.

SAFETY INSTRUCTIONS

The following safety instructions are provided to help prevent injury or limit equipment damage.



Safety Signs

Replace any missing or hard-to-read safety signs or instructional labels. Use care when washing or cleaning the wheel rake.

Replacement safety sign locations and part numbers are provided in this manual and are available from an authorized dealer parts department or the factory.



First Aid Kit

Have a first aid kit available for use should the need arise and know how to use it.



Fire Extinguisher

Have a fire extinguisher available for use should the need arise and know how to use it.

2.5 Operation Safety

Refer to “6.1 User Safety” on page 24 for safety recommendations related to using the wheel rake. All applicable safety recommendations in other sections should also be followed.

2.6 Transporting Safety

Refer to “2.6 Transporting Safety” on page 8 for safety recommendations related to transporting the wheel rake. All applicable safety recommendations in other sections should also be followed.

2.7 Storage Safety

Refer to “2.7 Storage Safety” on page 8 for safety recommendations related to storing the wheel rake. All applicable safety recommendations in other sections should also be followed.

2.8 Maintenance Safety

Refer to “9. Maintenance” on page 30 for safety recommendations related to maintaining the wheel rake. All applicable safety recommendations in other sections should also be followed.

2.9 Training

Anyone who will be using and/or maintaining the wheel rake must read, clearly understand, and follow ALL safety, operation, and maintenance information presented in this manual, other related OEM manuals, and the safety signs

If you do not understand any information in this manual, see your dealer or contact Ogden Metalworks before proceeding.

Do not use or allow anyone else to use this wheel rake until all information has been reviewed. Annually review this manual before the season start-up.

Make periodic reviews of SAFETY and OPERATION of the wheel rake a standard practice. An untrained operator is not qualified to use this wheel rake.

2.10 OSHA Training Requirements

The following training requirements have been taken from Title 29, Code of Federal Regulations Part 1928.57 (a) (6). www.osha.gov.

Operator instructions. At the time of initial assignment and at least annually thereafter, the employer shall instruct every employee who operates an agricultural tractor and implements in the safe operating practices and servicing of equipment with which they are or will be involved, and of any other methods dictated by the work environment.

2.11 Federal Laws and Regulations

IMPORTANT FEDERAL LAWS AND REGULATIONS CONCERNING EMPLOYERS, EMPLOYEES AND OPERATORS

This section is intended to explain in broad terms the concept and effect of the following federal laws and regulations. It is not intended as a legal interpretation of the laws and should not be considered as such.

U.S. PUBLIC LAW 91-596 (The Williams-Steiger Occupational Safety and Health Act of 1970) OSHA

This Act Seeks:

" ... to assure so far as possible every working man and woman in the nation safe and healthful working conditions and to preserve our human resources ... "

DUTIES

Sec. 5(a) Each Employer -

- (1) shall furnish to each of its employees employment and a place of employment which are free from recognized hazards that are causing or are likely to cause death or serious physical harm to its employees.
- (2) shall comply with occupational safety and health standards promulgated under this Act.
 - (b) Each employee shall comply with occupational safety and health standards and all rules, regulations, and orders issued pursuant to this Act which are applicable to his or her own actions and conduct.

OSHA Regulations

Current OSHA regulations state in part: "At the time of initial assignment and at least annually thereafter, the employer shall instruct every employee in the safe operation and servicing of all equipment with which the employee is, or will be involved." These will include (but are not limited to) instructions to:

Keep all guards in place when the machine is in operation;

Permit no riders on equipment;

Stop engine, disconnect the power source, and wait for all machine movement to stop before servicing, adjusting, cleaning, or unclogging the equipment, except where the machine must be running to be properly serviced or maintained, in which case the employer shall instruct employees as to all steps and procedures which are necessary to safely service or maintain equipment.

Make sure no one is within 300 feet of machinery before starting the engine, engaging power, or operating the machine.

EMPLOYEE TRACTOR OPERATING INSTRUCTIONS:

1. Securely fasten your seat belt if the tractor has a ROPS.
2. Where possible, avoid operating the tractor near ditches, embankments, and holes.
3. Reduce speed when turning, crossing slopes, and on rough, slick, or muddy surfaces.
4. Stay off slopes too steep for safe operation.
5. Watch where you are going, especially at row ends, on roads, and around trees.
6. Do not permit others to ride.
7. Operate the tractor smoothly - no jerky turns, starts, or stops.
8. Hitch only to the drawbar and hitch points recommended by tractor manufacturers.
9. When tractor is stopped, set brakes securely and use park lock if available.

Child Labor Under 16 Years Old

Some regulations specify that no one under the age of 16 may operate power machinery. It is your responsibility to know what these regulations are in your own area or situation. (Refer to U.S. Dept. of Labor, Employment Standard Administration, Wage & Home Division, Child Labor Bulletin #102).

3. SAFETY SIGNS AND LABELS

3.1 General Information

The types of safety signs (hazard labels) and instructional labels, along with their locations on the equipment, are shown in the following illustrations. Good safety practices require that you familiarize yourself with the various safety signs, the type of warning, and the area or particular operation related to that area that requires your SAFETY AWARENESS.



Think SAFETY!

Work SAFELY!

Pay close attention to the safety signs and instructional labels attached to the tractor and the wheel rake. Duplicate safety signs, which are attached to the wheel rake, can also be found in this section. If the wheel rake is missing a label or one is unreadable, replace the label before using the wheel rake.



**SAFETY
INSTRUCTIONS**

**Safety Signs and
Instructional Labels**

1. **Keep safety signs or instructional labels clean and legible at all times. Use a clean, damp cloth to clean safety decals.**
2. **Replace any missing or hard-to-read safety signs or instructional labels.**
3. **Use care when washing or cleaning the equipment not to remove or damage the labels. When using a pressure washer to clean the wheel rake, avoid spraying too close to decals; high-pressure water can enter through very small scratches or under edges of decals causing them to peel or come off.**
4. **Locations for the labels and replacement part numbers are shown in this section.**
5. **Replacement parts must have replacement labels attached during installation and/or before the wheel rake is used.**
6. **Labels are available from your authorized dealer or from Ogden Metalworks at no charge.**

3.2 Decals



To prevent
serious

injury or death from not following posted safety instructions, make sure all decals are attached to the unit and are legible at all times.

Safety decals provide a vital role in helping to reduce injuries and/or possibly even death. To ensure the greatest level of safety, all decals must be in place and legible at all times. Remember, it is the user's responsibility to maintain these decals.

All decals must be in place and legible or all warranties are void.

3.3 How to Install Replacement Safety Signs

1. Clean and dry the installation area.

Note: Do not install the signs if the temperature is below 50°F.

2. Determine the exact position before you remove the backing paper.
3. Remove the backing paper.
4. Align the sign over the specified area and carefully press the sign to the part/frame.

Note: Small air pockets can be pierced with a pin and smoothed out using the piece of backing paper.

3.4 Safety Sign Locations



Item	Part Number	Description	Qty.
1	HR169	Decal, Warning Operating	1
2	HR170	Decal, Overhead Hazard	2
3	0-70	Decal, Caution Stay Clear	5
4	HR171	Decal, Warning Pinch Point	2
5	0-82	Decal, Hydraulic Caution	1
6	0-71	Decal, Red Reflector	2
7	B489A	Decal, Yellow Reflector	2

3.4.1 Wheel Rake Safety Signs

1.



2.

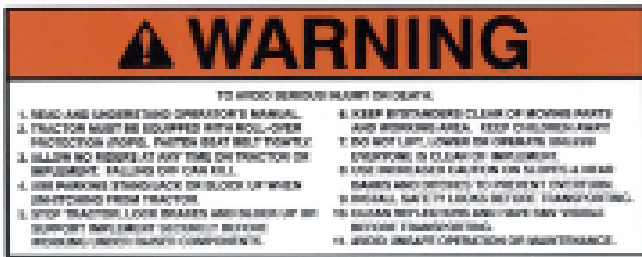

3.

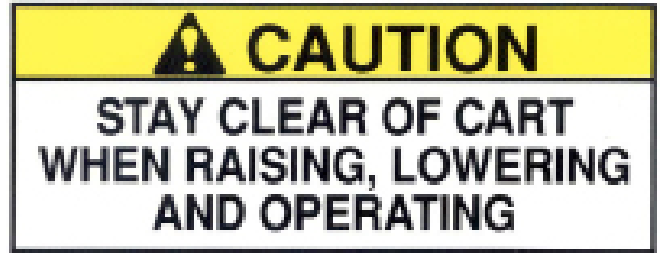

4.



5.

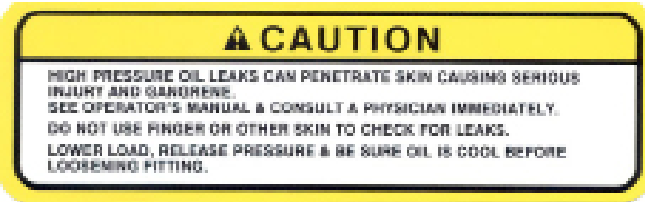

6.

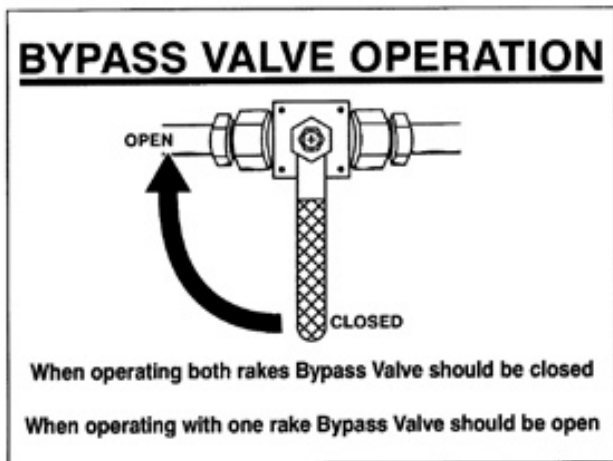
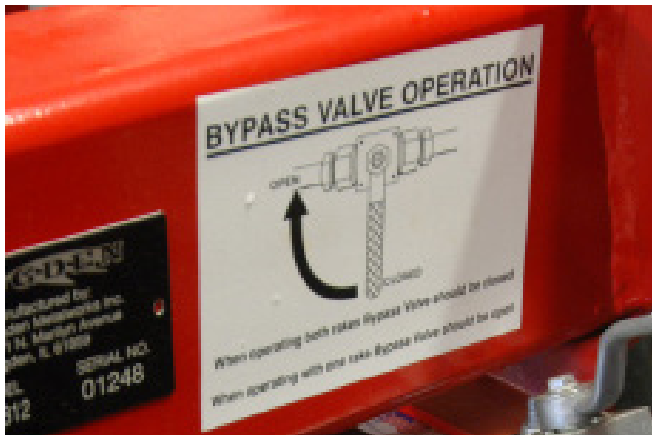

4. Assembly

4.1 Assembly Area

1. The assembly area should be a clean, flat, solid surface.
2. It will be necessary to use a lifting mechanism such as a forklift or overhead lifting device.
3. Sturdy supports or blocking may also be needed.

Note: When reading the assembly instructions, the directions (LEFT and RIGHT) are always referred to from standing behind the piece of equipment (BACK) looking forward toward the tractor (FRONT).

4.2 Quick Reference Guide

1. With the rake on the ground and the rake arms in the raised and locked position, support the front of rake right behind the shipping support stand.



2. Remove the shipping support stand.
3. If a center wheel kit is not being installed, the tongue extension can be removed. Typically the tongue extension would only be removed to shorten the overall length of the unit which is not commonly done. For detailed information refer to “4.3 Tongue Extension” on page 14.
4. Attach the tongue assembly. For detailed information refer to “4.4 Attach the Tongue Assembly” on page 15.
5. Connect hydraulic supply and return hoses.
6. Release the transport lock on both rake arms. For detailed information refer to “4.5 Rake Arm Transport Locks” on page 16.

7. Lower the rake arms and, if necessary, attach the single or double rake wheel extension. For detailed information refer to “4.6 Attach Optional Single or Double Wheel Extension” on page 16.
 - a. The unit is already set up for an eight wheel configuration.
 - b. For a ten wheel configuration, attach the single rake wheel extension.
 - c. For a twelve wheel extension, attach the double rake wheel extension.
8. Install the optional center wheel kit. For detailed information refer to “4.7 Hay Rake Wheels” on page 17.
9. Adjust the height of the hitch. For detailed information refer to “4.8 Adjust Height of Hitch” on page 17.
10. Grease the pivot pins. For detailed information refer to “4.9 Grease the Pivot Pins” on page 17.
11. Install any other optional accessories, such as the center wheel kit. For detailed information refer to “4.10 Optional Center Wheel Kit” on page 18.

4.3 Tongue Extension

The tongue extension comes standard with every rake; however, it can be removed to shorten the length of the tongue.





Note: The tongue extension is required to mount the Dual Center Wheel kit if purchased, as shown.

To remove the tongue extension, follow these steps.

1. Unfold both wings (all the way down), so the rake wheels rest on the ground.
2. Unhook the hydraulic hoses from the tractor.
3. Loosen the hose holder clamp on top of the tongue and move the hoses to the rear main frame.
4. Use the jack stand to raise the front of the wheel rake. Move the tractor away from the work area.
5. Place large, sturdy blocks under the center of the main frame. Make sure the blocks, and the main frame are stable before lowering the jack stand.
6. Lower the jack stand and remove it. All the weight of the main frame should be resting on the blocking.
7. Securely attach a lifting strap to the tongue. Position the strap to balance the weight of the tongue as it is removed.
8. Remove the six 5/8" bolts, lock washers, and nuts connecting the tongue to either the main frame or the tongue extension. Place the tongue away from the work area.

CAUTION The tongue weighs approximately 96 pounds and may cause crushing injuries if not handled properly.

9. If removing the tongue extension, securely attach a lifting strap to the tongue extension. Position the strap to balance the weight of the tongue as it is removed. Remove the six 5/8" bolts, lock washers, and nuts connecting the tongue to the main frame.

CAUTION The tongue extension weighs approximately 80 pounds and may cause crushing injuries if not handled properly.

10. Attach the tongue or the tongue extension with six 5/8" bolts, lock washers, and nuts each. Tighten the nuts to the standard torque.
11. Reroute and attach the hoses to the frame.

4.4 Attach the Tongue Assembly

Support the frame assembly.

CAUTION Stay clear of the wheel rake while it is temporarily supported. Do not work under any part of the unit.

1. Remove the six 5/8" bolts, lock washers, and nuts connecting the shipping support stand to the main frame.
2. Attach the tongue assembly using the removed hardware.
3. Tighten the nuts to the standard torque.



4. Attach the jack stand, remove the blocking, and lower the tongue to the desired height.



5. Make sure the slow-moving sign is installed before transporting.

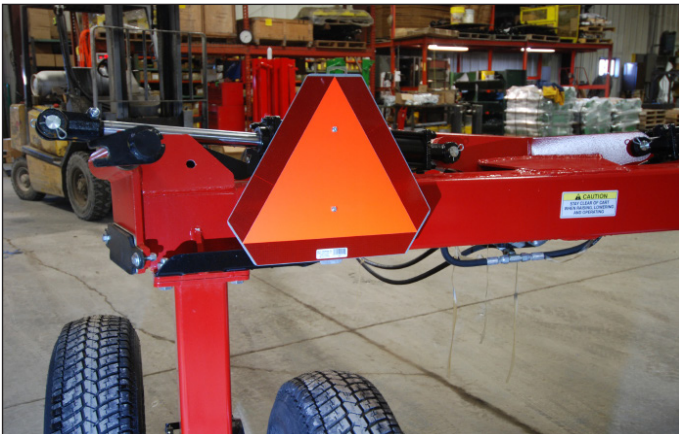

4.5 Rake Arm Transport Locks

The wheel rake is shipped with the transport locks in the locked position to prevent the wings from lowering unexpectedly.



1. Before applying hydraulic pressure, make sure the transport locks are unlocked and pinned in the unlocked position.

NOTICE

If the transport locks are not unlocked and the wheel rake arms are lowered, the locks are designed to break away if enough pressure is applied. If the locks are damaged in any way, do not use the wheel rake. Repair any damage before continuing to use the wheel rake.

2. Place the lock pin through the transport lock and install the retainer clip.

4.6 Attach Optional Single or Double Wheel Extension

1. Attach the rake wheel extension with four 1/2" bolts, lock washers, and nuts. Tighten the nuts to the standard torque.



4.7 Hay Rake Wheels

1. The hay rake has right and left-hand rake wheels, and it is important they are installed correctly.
2. The rake tines at the bottom of the wheel where the tine touches the ground should point forward (toward the tractor).
3. The carriage bolt heads in the center of the wheel that bolt down the rake tines should be on the side of the wheel that touches the hay.



4.8 Adjust Height of Hitch

NOTICE The tongue clevis is adjustable and should be adjusted, so the rake is as level as possible when raking.



1. Remove the two retaining bolts and adjust the hitch to the desired height.
2. Reinstall both mounting bolts and tighten the hardware.

CAUTION Use only OEM-supplied hardware to mount the hitch to the hay rake frame. Use of a lesser grade bolt could result in failure of the hitch causing property damage or personal injury.

4.9 Grease the Pivot Pins

Once the unit is assembled, grease the following three pivot point locations. If the rake has been sitting for an extended period of time, refer to the Lubrication section and grease the remaining grease points.

1. Grease the two mainframe hinge pins; one on each side.



2. Grease the two rake arm hinge pins; one on each side.



3. Grease the rake arms. Move the arms up and down several times to ensure complete lubrication.



The zerks for the rake arms are on the bottom side of the tube.

4.10 Optional Center Wheel Kit

The Center Wheel Kit mounts on the front of the wheel rake and is designed to move the hay that lays in the center of the row that would not be moved by the main rake assemblies.

Use the hydraulic valve on the cylinder to raise and lower with the center wheel rakes.

When transporting, raise the center wheel rakes then close the hydraulic valve.

Use the following instructions and the parts book page as item number reference to install the center wheel kit on the tongue extension.

1. Start by attaching the rake to a tractor. Unfold the rake arms with the rake wheels flat on the ground.

CAUTION

Release all hydraulic pressure.

2. Loosely attach mount plate (1) to the tongue extension using two 5/8" U-bolts (5), four lock washers (6), and four hex nuts (7).
3. Slide the mount plate forward until the U-bolt hits the weld on the tongue extension but stays straight perpendicular to the plate. Tighten the four nuts.
4. Install left-hand rake arm (8) in the front ears of the mount plate and right-hand rake arm (10) in the back ears using pivot pin (2), flat washer (3), and a cotter pin (4).

Note: Insert pivots pins (2) from the rake wheel side with the two bent ears facing up and sliding around the ear of the mount plate.

5. Loosely install cylinder mount plate (37) with the welded lug angling backward with two 5/8" U-bolts (5), four lock washers (6), and four hex nuts (7).
6. Position the back of the cylinder mount plate 42-1/4" from the front of the pivot mount plate.



7. Install cylinder (27) with the fittings facing the left side of the rake to the cylinder mount plate. Install cylinder pin (28) with cotter pin (4).
8. Extend the cylinder rod and connect it to the linkage arm (9) using cylinder pin (28) and cotter pin (4).

Note: The slots in the linkage arm are convex shaped, and the ends must be installed facing upward like a smile (not a frown).

9. Attach each rake arm to linkage (9) using pins (41), washers (3), and clips (29).



10. Use one hose (33) and connect it to the cylinder's rod end port and then into the t-fitting in the system's supply hose.

11. Use the other hose (33) and connect it to the cylinder's rear port and then into the t-fitting in the system's return hose.



12. Attach the two rake wheels with six hex flange nuts (15) each.



Note: Install the rake wheel labeled LH (left-hand) on the right side, and the rake wheel labeled RH (right-hand) on the left side. This orientation is opposite from the main rake wheels.

5. Initial Set Up

5.1 Setting Up the Wheel Rake

Properly setting the wheel rake is essential for efficient operation. There are several required adjustments prior to using the wheel rake.

1. Attach the wheel rake to the tractor. For detailed information refer to “5.2 Attaching to Tractor” on page 20.
2. Purge all trapped air from the hydraulic lines and cylinders. For detailed information refer to “5.3 Purge Air from Hydraulic Lines and Cylinders” on page 20.
3. Adjust the hitch to level the rake from front to back. This is an essential adjustment to make sure the rake operates efficiently. Refer to “5.4 Level the Rake” on page 21.
4. Adjust the width of the rake. For detailed information refer to “5.5 Wing Extension Adjustment” on page 21.
5. Adjust the angle of the rake arms. For detailed information refer to “5.6 Rake Angle Adjustment (rear center rake wheels)” on page 22.
6. Adjust the ground pressure of the rake wheels. For detailed information refer to “5.8 Adjust Rake Wheel Ground Pressure” on page 23.

5.2 Attaching to Tractor

CAUTION Use caution when connecting the wheel rake to the tractor. The wheel rake should be securely resting at ground level or setting on blocks. Keep hands and feet clear of pinch points between the tractor drawbar and wheel rake hitch.

1. Use the jack to adjust the hitch to the height of the tractor drawbar.
2. Back the tractor up to align the drawbar and hitch pin holes.

CAUTION Do not stand or allow anyone else to stand between the tractor and the wheel rake while the tractor is moving or the engine is running.

3. Turn off the tractor engine, set the parking brake, and dismount.

4. Insert a 1” hitch pin with retaining clip through the clevis and drawbar holes and install retaining clip.

SAFETY INSTRUCTIONS

Use only an OEM high strength drawbar pin. Do not use a homemade or shop made pin.

5. Raise the jack and place it in the storage position.
6. Route the hydraulic hoses along the tongue of the wheel rake and connect to the tractor’s hydraulic ports.

SAFETY INSTRUCTIONS

Make sure the hoses are adequately supported, so they do not contact the ground and will not pinch or be stretched when turning a corner.

Note: Quick disconnect hydraulic couplers are not supplied with the unit; however, they may be purchased through your local dealer.

5.3 Purge Air from Hydraulic Lines and Cylinders

NOTICE

Keep hoses and fittings clean at all times. Be sure all connections are properly sealed to avoid leakage. To connect hoses and couplings, only use a liquid type thread sealant (do not use Teflon thread tape).

CAUTION

Make sure the area around the rake is clear of people, animals, or obstructions before lowering the rake arms.

1. Connect the supply and return hoses to the tractor.
2. Release both transport locks.



3. Close the center bypass valve, as shown.



4. Open both rake arm lift cylinder valves, as shown.



5. Operate the hydraulic cylinders through several cycles to purge all the trapped air from the system until the rake arms raise and lower smoothly.

CAUTION Trapped air in the hydraulic system and the cylinders can cause the rakes to fall abruptly to the ground.

6. If a center wheel attachment is connected to the hydraulic system, open the valve and raise and lower the two rake wheels several times.

5.4 Level the Rake

It is very important that the wheel rake is level in the operating position.

1. Using the jack, adjust the tongue up or down so that the main frame is level.
2. Position the back of the tractor near the hitch.
3. Remove the two retaining bolts and adjust the hitch to the required height.

4. Reinstall both mounting bolts and tighten the hardware.

CAUTION Use only OEM-supplied hardware to mount the hitch to the hay rake frame. Use of a lesser grade bolt could result in failure of the hitch causing property damage or personal injury.

5. Attach the wheel rake to the tractor following the procedure in “2. Purge all trapped air from the hydraulic lines and cylinders. For detailed information refer to “5.3 Purge Air from Hydraulic Lines and Cylinders” on page .” on page 20.
6. Recheck the main frame to make sure it is level.
7. Place the jack in its transport position.

5.5 Wing Extension Adjustment

The rear two rake wheels can be independently adjusted without affecting the overall raking width. This allows operating the rake at a wide pitch in lighter crops while maintaining a wide windrow or operating the rake at a narrow pitch in heavy crops and maintaining a narrow windrow.

1. The unit is normally shipped with the wings adjusted all the way inward.
2. To adjust the width, loosen the 3/4” U-bolts.



3. Lift the wing extension high enough to raise the rake wheels off the ground.
4. Move the wing extension to achieve the desired raking width or windrow width. An internal stop will prevent the wing extension from detaching from the receiving tube.

CAUTION The wing extension weighs approximately 42 pounds and may cause crushing injuries if not handled properly. Do not place any part of your body in a pinch point location while making these adjustments.

5. Retighten the U-bolt nuts to 315 ft. lbs. of torque.

5.6 Rake Angle Adjustment (rear center rake wheels)

The angle of the rear four center rake wheels can be adjusted to operate at a steeper angle in heavy crops or at a flatter angle in light crops and still maintain the desired windrow width.

1. Using the tractor hydraulics, slightly raise the wings off the ground and shut the tractor off.

CAUTION Shut the tractor off and apply the parking brake before making this adjustment. DO not place any part of your body under the wing of the rake.

SAFETY INSTRUCTIONS As an added precaution, support the wing in the raised position to prevent it from lowering to the ground while the adjustments are made.



2. Loosen the threaded tear-shaped lock tab.
3. Pivot the rake arm to the desired angle using the turnbuckle.
4. Retighten the threaded lock tab.
5. Repeat the process for the other wing.

5.7 Rake Angle Adjustment (front center rake wheels)

The angle of the front four rake wheels (including the additional rake wheels on the 10 and 12 rake wheel models) can also be adjusted to six different settings to adjust the overall width.



1. Remove the nut and washer from the lock pin. Remove the pin and slide the rake wheels into the desired angle.



2. Reinsert the lock pin. Install the flat washer and nut and securely tighten the nut.

5.8 Adjust Rake Wheel Ground Pressure

The rake wheels are ground driven and require ground contact in order to operate properly. It's important to have the correct ground pressure to achieve the desired raking action without damaging the crop.

Excessive rake wheel ground pressure can cause crop damage, premature rake wheel tine wear, and broken tines.

1. Adjust the spring pressure by loosening or tightening the eye bolt.
2. Tightening the eyebolt decreases the ground pressure. This work well with lighter hay.



Minimum Ground Pressure

3. Loosening the eyebolt increases the ground pressure. This work well with heavier hay.

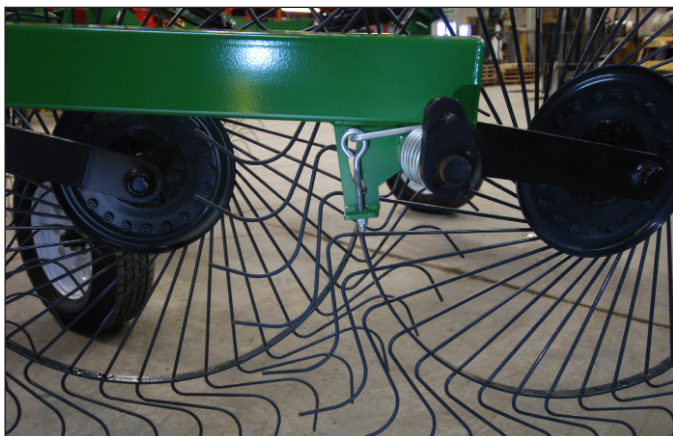

Maximum Ground Pressure

6. Wheel Rake Operation

6.1 User Safety

Also, refer to “2.4 General Safety Instruction” on page 7 for user safety training requirements.

WARNING Before operating, the user should be familiar with these operating instructions and operation of the tractor.

Do not allow an unqualified person or one under the influence of medication or intoxicating substances to operate the tractor.

Never allow children to operate equipment.

Before using the wheel rake, check the tightness of lug bolts, spindle set screws, and all other bolts and nuts. Grease all pivot points including the main frame hinge, pivot hinge, rake arm hinge, transport hub, rake wheel hubs, tandem pins (optional), and center wheel pins (optional).

WARNING Failure to follow the following safety instructions could result in serious injury and possibly even death if they are not understood and followed.



Train Unfamiliar Users

It is the wheel rake owner's responsibility to make sure any person using the wheel rake, especially if it is loaned or rented, has been thoroughly trained on its proper and safe use.



Crush Hazard (Roll Away)

Whenever leaving the tractor's operator seat for any reason:

1. Shut off the engine and remove ignition key.
2. Set the parking brakes.
3. Relieve hydraulic fluid pressure.
4. If parking the unit, make sure jack stand is lowered and retaining pin is installed.



Crush Hazard

The weight of the tractor, plus the wheel rake, if it rolls onto a person, could cause serious crushing injury or death.



Crush Hazard

The tractor should be equipped with a Roll Over Protective Structure (ROPS) and a seat belt. A crushing hazard could occur if the driver is ejected from the seat while the tractor is in motion. Fasten the seat belt whenever the tractor is moving.



Crush Hazard

Hydraulic or mechanical failure can allow a wing to drop suddenly without warning. Do not allow anyone to walk under or stand near a raised wing when the wing locks are removed.



Make sure the wings are locked whenever they are in the folded position before working around the machine or for transporting.

SAFETY INSTRUCTIONS

The following safety instructions are provided to help prevent injury or limit equipment damage.

Be certain only physically-able persons will use the wheel rake.

If the elderly are assisting with the work, their physical limitations need to be recognized and accommodated.

Before operating the machine inspect for loose or damaged bolts or parts and make necessary repairs before starting.

6.2 Hydraulic Requirements

Note: The Hay Runner requires 1900 psi of hydraulic pressure to operate correctly.



CAUTION

This unit operates with a minimum hydraulic pressure of 1900 psi. Do not exceed the maximum hydraulic system pressure of 3000 psi.

6.3 Using the Wheel Rake

1. Begin raking at a low ground speed until you are familiar and comfortable with the rake.
2. A good working speed is normally 6 to 10 mph and will vary with different hay conditions or terrain.
3. Reduce the ground speed when working on hills or rough terrain.
4. Rake the hay in the correct direction to make raking more efficient.
 - a. For sickle mowed hay, rake in the same direction as mower travel.
 - b. For rotary mowed hay, rake in the opposite direction of the mower's travel.
5. Most raking problems can be traced to incorrect speed, incorrect ground pressure, or broken or missing tines.
6. Use only enough ground pressure to pick up the crop material.

NOTICE *Raise the rake wheels before backing the tractor. Backing the tractor with the tines in contact with the ground will cause tine breakage.*

6.3.1 Raising Front Wheel Rakes



The front one (10 wheel model) or two (12 wheel model) rake wheels can be raised off the ground.

1. Remove the wire lock pin from the front wheel clip.



2. Turn the front wheel clip around and reinstall the wire lock pin.
3. Raise the wheel and hook front wheel clip around the wheel rake arm.



6.3.2 Raising Center Wheel Rakes

1. The center wheel rakes work in conjunction with the rake arm wheel rakes. When the rake arms are raised the center wheel rakes will also raise.
2. To prevent the center wheel rakes from lowering, close the valve when the rakes are in the up position.

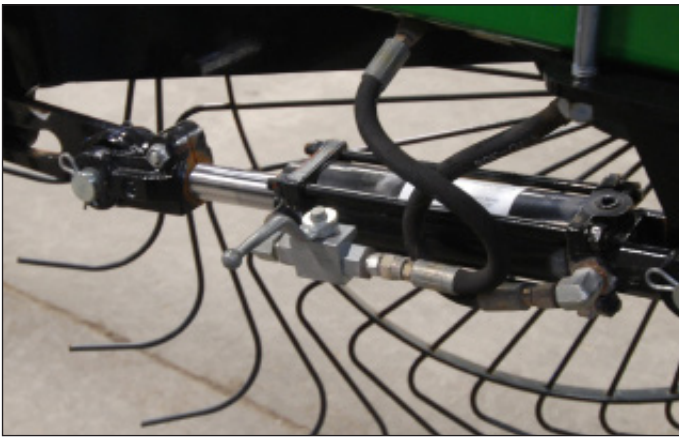

6.3.3 Single Sided Rake Operation

1. Release the transport lock on the side being lowered to the ground. The other side should be locked in place.



2. Open rake arm lift cylinder valve. The open position is when the valve handle is in line with the valve body.



3. Close the lift cylinder valve on the rake arm which is not being lowered. The closed position is when the valve handle is in perpendicular with the valve body.
4. Open (handle in line with valve) the center bypass valve.
5. Be sure to close this bypass valve (handle perpendicular) when using both rakes.

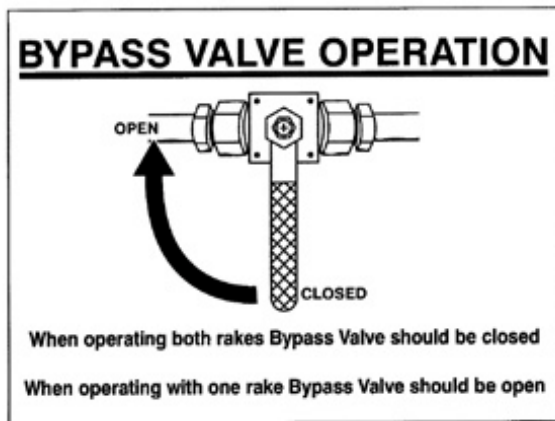

CAUTION Make sure all hydraulic pressure is relieved before disconnecting hydraulic hoses between the wheel rake and the tractor hydraulic system.

Escaping hydraulic fluid under pressure, even a pinhole size leak, can penetrate body tissue, causing serious injury and possible death. If fluid is injected into your skin, it must be treated immediately by a doctor familiar with this type of injury.

5. Remove the hitch pin and drive the tractor away from the wheel rake.

6.4 Detaching From Tractor

1. Raise the wings with the tractor hydraulics and install the wing locks.

CAUTION Hydraulic or mechanical failure can allow a wing to drop suddenly without warning. Do not allow anyone to walk under or stand near a raised wing when the locks are removed.

2. Park the tractor, place the transmission in park or neutral, and apply the parking brake. Shut down the engine, remove the key, and move the cylinder operating lever in both directions to relieve hydraulic pressure. Wait for all motion to come to a complete stop before exiting the tractor.
3. Remove the jack from the main frame and secure it to the hitch by fully inserting the locking pin through the jack and the hitch bracket. Use the jack to raise the rake hitch to the height needed to disconnect the clevis from the drawbar.
4. Disconnect the hydraulic hoses from the tractor. Secure the hoses up off the ground.

7. Transporting

7.1 Transporting Safety (Road)

WARNING Failure to understand and follow these safety instructions could result in serious injury and possibly even death.

Operating the Tractor
Before attaching the wheel rake to the tractor, be familiar with its controls and how to stop it quickly in the event of an emergency. Read and understand this manual and the one provided with your tractor before transporting the wheel rake.

Fall and Crush Hazard
Do not allow riders on the wheel rake or tractor.

Maximum Transporting Speed
Do not exceed 20 MPH when transporting the wheel rake. Slow down for corners and rough terrain. Never transport faster than surface conditions allow.

Visibility
Clean reflectors, SMV or SIS sign, and tractor tail lights before towing. Make sure all the lights and reflectors required by highway and transport authorities are in place and will be clearly seen by all traffic.

Regulations
Obey all applicable local, state, and federal regulations, regarding the transport of equipment on public roads and highways. Check with the local authorities regarding transporting the wheel rake on public roads.

SAFETY INSTRUCTIONS The following safety instructions are provided to help prevent injury or limit equipment damage.

Be a safe and courteous driver. Anticipate road conditions and drive accordingly.

Apply brakes early. Extra distance is required to stop the tractor and wheel rake.

Use care around unmovable objects that prevent clear vision of the complete work area.

Be sure the wheel rake is securely attached to the tractor and in good operating condition before using.

For wheel rakes without lights, install additional lights on the rear of the tractor to safeguard against rear-end collisions. Daybreak and dusk are particularly dangerous, and rear pilot vehicles are recommended. Wheel rakes without lights should be transported on public roads only during daylight hours.

Use hazard flashers on the tractor when transporting unless prohibited by law.

When traveling below the posted speed limit, keep to the right and yield the right-of-way to allow faster traffic to pass.

7.2 Transporting Procedure

1. Raise the rake arms and place both transport locks in the closed position. Place both hydraulic cylinder valves in the closed position.

CAUTION Prior to moving the rake, the transport locks must be closed, the retaining pins installed, and the retaining clips inserted into the retaining pins.



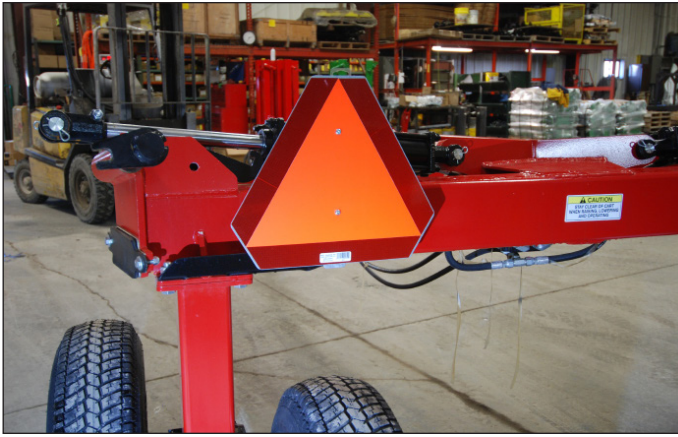

2. Make sure the jack stand is secured in its storage location on the left side of the frame.
3. Tow the wheel rake to the work site following all applicable regulations and all the safety instructions in this manual.

⚠ WARNING The wheel rake is top heavy when the rake arms are raised. To prevent rollover, use caution when traveling over uneven surfaces and slow down for turns.

8. Storage

At the end of the season, the wheel rake should be thoroughly inspected and prepared for storage. Repair or replace any worn or damaged components to prevent any unnecessary downtime at the beginning of the next season.

8.1 Placing In Storage

To extend the life of the cylinders and hoses, store the wheel rake inside a building.

1. Remove all entangled vegetation.
2. Thoroughly wash the wheel rake to remove all clippings, dirt, mud, or debris.
3. Raise the rake arms and install the wing locks and their retaining pins.
4. Store the wheel rake in an area that is dry, level, and free of debris (inside a building is ideal).

SAFETY INSTRUCTIONS

Store the wheel rake in an area away from human activity. Do not permit children to play on or around the stored wheel rake.

5. Lubricate all grease points. Make sure all grease cavities have been filled with grease to remove any remaining water from washing.
6. If the unit is stored outdoors, cover the exposed cylinder rods with grease.
7. Touch up all paint nicks and scratches to prevent rusting.

8. Removing From Storage

1. Grease all lubrication points. Refer to “Lubrication” on page 32.
2. Before placing the wheel rake back into service, visually inspect for any worn or defective parts and replace them as necessary.
3. Check the tire pressure and fill as needed.

9. Maintenance

9.1 General Maintenance Safety

WARNING Failure to comply with the following safety instructions could result in serious injury and possibly even death.



Personal Protection Equipment

Wear personal protection equipment (PPE), which may include hard hat, safety glasses, safety shoes, gloves, etc. appropriate for the work site and working conditions.

9.2 Work Area

WARNING Failure to comply with the following safety instructions could result in serious injury and possibly even death.



Crush Hazard

Always set the wheel rake on safety stands or on the ground and chock the wheels when performing maintenance.



Crush hazard

The rake arms can drop unexpectedly if the wing locks are not installed. Whenever the wings are raised the transport locks, and their retaining pins must be installed.



The wheel rake is top heavy when the wings are raised. Make sure the rake is on a firm, level surface before performing any maintenance.

SAFETY INSTRUCTIONS

The following safety instructions are provided to help prevent injury or limit equipment damage.

A fire extinguisher and first aid kit should be readily accessible while performing maintenance on this equipment.

Do not leave tools lying around the work area. Follow good shop practices. Keep service area clean and dry. Be sure electrical outlets and tools are properly grounded. Use adequate light.

Keep all parts in good condition and properly installed. Fix damage immediately. Replace worn or broken parts.

Use the correct tools, jacks, hoists, or other tools that have the capacity for the job.

Use certified safety stands rated to support the wheel rake's weight when working beneath the wheel rake.

Do not position jack stands under moveable parts. Test the stability of the wheel rake before working underneath.

If the wheel rake is attached to the tractor, set the brakes, remove the key, chock the tractor wheels, and block the wheel rake before working underneath.

9.3 Parts Replacement

SAFETY INSTRUCTIONS

Replacement parts must be genuine factory replacement parts to restore the unit to its original specifications. The manufacturer will not accept responsibility for damages as a result of using unapproved parts.

Replace any worn, cut, abraded, flattened, or crimped hoses.

⚠ WARNING Failure to comply with the following safety instructions could result in serious injury and possibly even death.

9.4 Hydraulic System Safety



Hydraulic Pressure

This unit operates with hydraulic pressures of 1900 to 3000 psi.



High-Pressure Hydraulic Oil

1. Check or tighten all connections **BEFORE** pressurizing system.



2. Release all pressure before removing hoses or couplings by:

- a. Stopping engine.
- b. Holding hydraulic control levers in float or neutral position.



3. **DO NOT** use your bare hand to check for potential leaks. Always use a board or cardboard when checking for a leak.

Escaping hydraulic fluid under pressure, even a pinhole size leak, can penetrate body tissue, causing serious injury and possible death. If fluid is injected into your skin, it must be treated immediately by a doctor familiar with this type of injury.



High-Pressure Components

Immediately replace any damaged hydraulic hoses, fittings, or components.



Trapped Air

When installing, replacing, or repairing hydraulic system components, make sure the entire system is free of trapped air before resuming operations.



Zero Pressure

Relieve all pressure from the hydraulic system before servicing or disconnecting any components.

9.5 Welding Repairs



Before performing any type of welding repair to the wheel rake, contact Ogden Metalworks for approval. Repair welding must be done with care and with procedures that may be beyond the capabilities of the ordinary welder.

⚠ WARNING Poorly done repairs or modifications to the wheel rake can result in serious injury or death should these repairs fail.

NOTICE Anyone performing a welding repair should be certified in accordance to the American Welding Society (AWS) standards.

9.6 Wheel Bearings

Seasonally clean, repack, check for excessive end play and adjust the wheel bearings. Repack the bearings with a multipurpose wheel bearing grease.

1. Remove the wheel and disassemble the hub assembly.
2. Remove the old grease and thoroughly clean all the parts.
3. Push a multipurpose wheel bearing grease, by hand, into the tapered roller bearings. Start from the wide side of the bearing and keep pushing the grease into the bearing until the roller cage is filled.
4. Coat the inside of the hub (bearing race) with grease.
5. Reassemble the hub onto the spindle making sure to replace the rear seal.
6. Snuggly install the spindle nut with a wrench.
7. Install the wheel and then tighten the spindle nut an additional one-quarter turn while rotating the wheel ten revolutions. This will seat the bearings.
8. Loosen the spindle nut and rotate the spindle. Retighten the spindle nut firmly, but not too tight, with a wrench and then loosen it enough to install the cotter pin.
9. Tighten the lug nuts.

9.7 Replacing Tines

If it becomes necessary to replace damaged tines, install them as shown.

1. Remove the nuts from the tine retaining bolts.



2. Remove the retaining bolts and the tine clamps.



3. Reinstall the tines, as shown.



The tine clamp is shown removed for clarity of the assembled tines around the retaining bolt.

Lubrication

1. Grease the flotation rods on a dual axle wheel spindle every 15 hours of operation.

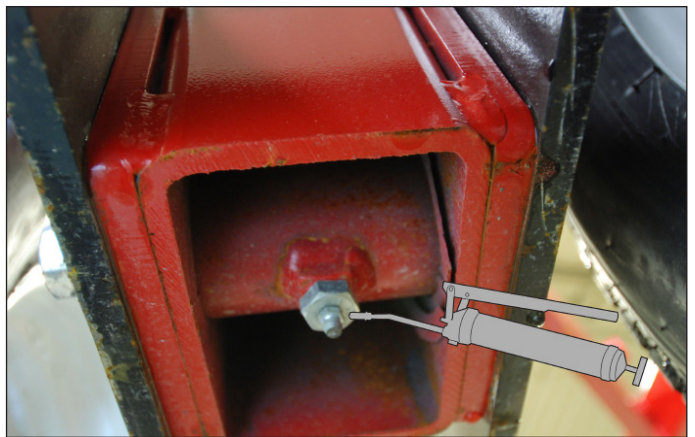

2. Lubricate the dual spindle axle seasonally.



3. Grease the wheel rake arm pivot pins.

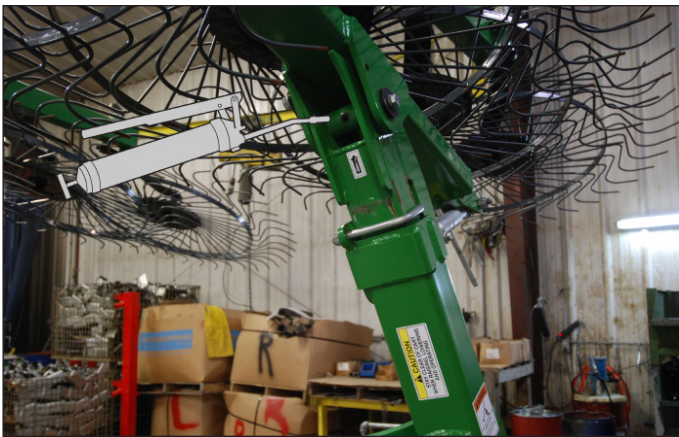

4. Grease the wheel rake hubs.



5. Grease the rake arm pivot shaft.



9.8 Inspection

1. Periodically check the spindle retaining bolt to make sure it is tight.



2. Check the hydraulic hoses periodically for cracks, abrasions or leaks. Replace defective hoses immediately with factory replacement parts only.

3. Check tightness of lug bolts after one hour of operation and every six months thereafter. Check tire pressure whenever maintenance is performed.

9.9 Replacing Rake Wheel Tension Spring

1. Release the tension on the eye bolt.

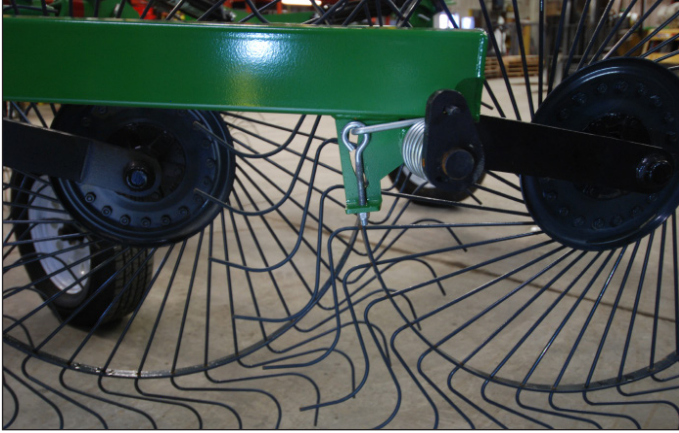

2. Raise the rake wheel and clamp it into the raised position.

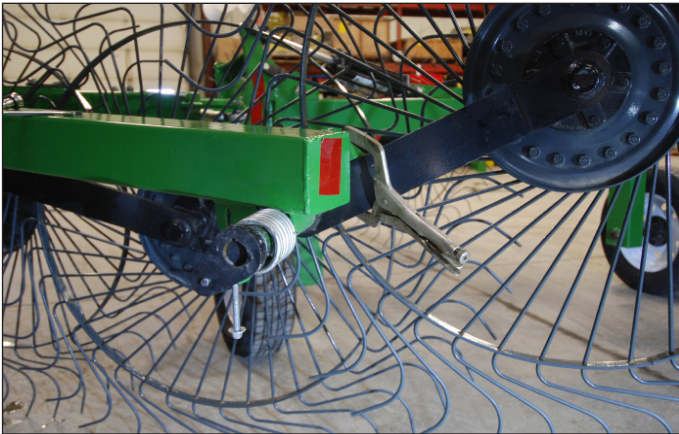

3. Loosen the set screw and use a bearing puller and remove the spring block. If the spring is still connected to the spring block it will be under minimal tension that will be released when the spring block is removed.

CAUTION Keep hands and fingers away from the spring.



4. Install the new spring, as shown.

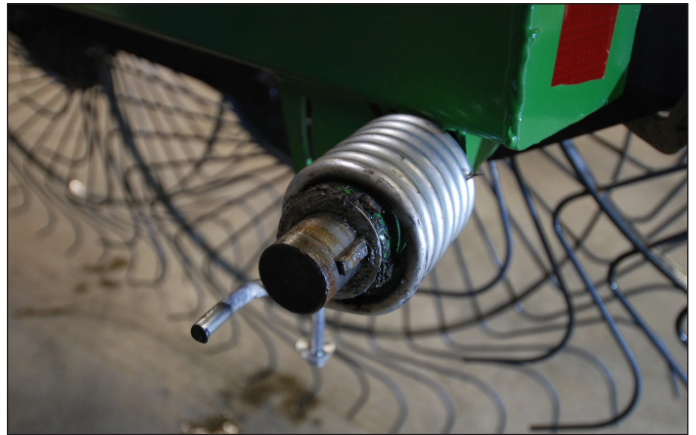

5. Place the end of the spring into the spring block and install the spring block onto the shaft.

Note: The spring block must be rotated upward (adding spring tension) to align the keyway with the key in the shaft.



6. Tap the spring block onto the shaft and tighten the set screw.



7. Remove the clamp and lower the rake wheel to the ground. Retention the eye bolt to obtain the desired ground pressure on the rake wheel.

9.10 Bolt Torque Requirements

It is extremely important to apply and maintain proper torque on all bolts. Use a torque wrench to assure the proper amount of torque is being applied to the fastener.

Start all bolts or nuts by hand to prevent cross threading.





Torque figures indicated in the chart are used for non-greased or non-oiled threads unless otherwise specified. Therefore, do not grease or oil bolts or cap screws unless otherwise specified in this manual. When using locking elements, increase torque values by 5%.

The chart gives correct torque values for various bolts and cap screws. Tighten all bolts to the torque specified in the chart unless otherwise noted. Check tightness of bolts periodically, using the bolt torque chart as a guide. Always replace hardware with the same Grade bolt.

SAFETY INSTRUCTIONS

The torque value for bolts and cap screws are identified by their head markings. Replacing higher "Grade" bolts (Grade 5) with lower Grade bolts will lead to equipment failure and can result in injury or death. Always use replacement bolts with the same Grade markings as the removed bolt.

Standard Torque Values

Bolt Diameter 	English Bolt Torque Specifications					
	Grade 2  No Marking		Grade 5  3 Radial Lines		Grade 8  6 Radial Lines	
	N·m	ft.lbs.	N·m	ft.lbs.	N·m	ft.lbs.
1/4"	8	6	12	9	17	12
5/16"	13	10	25	19	36	27
3/8"	27	20	45	33	63	45
7/16"	41	30	72	53	100	75
1/2"	61	45	110	80	155	115
9/16"	95	60	155	115	220	165
5/8"	128	95	215	158	305	220
3/4"	225	165	390	290		398
7/8"	230	170	570	420	880	650
1"	345	225	850	630	1320	970

10. Troubleshooting

Problem	Cause	Solution
Hay is carrying around the wheels.	Tines not polished.	Continue to operate rake to polish tines.
	Mud on tine ends	Material too wet. Allow to dry. Do not operate in wet ground.
Tine breakage.	Backing up with tines in contact with ground.	Do not back up with tines in contact with ground.
	Too much ground pressure.	Decrease the ground pressure. Refer to "5.8 Adjust Rake Wheel Ground Pressure" on page 23.
Rake wheels bounce excessively.	Too little ground pressure.	Increase the ground pressure. Refer to "5.8 Adjust Rake Wheel Ground Pressure" on page 23.
Rake is missing hay.	Wheels running too fast.	Adjust rake arm angle. Refer to "5.6 Rake Angle Adjustment (rear center rake wheels)" on page 22.
	Tines missing or worn.	Replace tines. It is best to replace all tines at the same time to keep a uniform height.
Bent tines.	Backing up with tines in contact with ground.	Do not back the tractor with tines in contact with ground.
	Excessive speed on rough ground.	Reduce speed.
	Narrow or deep ditches or furrows, rocky ground.	Avoid or cross at a slow speed.
	Too much ground pressure.	Decrease the ground pressure. Refer to "5.8 Adjust Rake Wheel Ground Pressure" on page 23.

11. Replacement Parts

11.1 Ordering Parts

We manufacture a quality product that requires very little maintenance or repair. However, should a part break or become damaged, our knowledgeable staff can make sure you receive the part(s) to put your unit back into operation.

Contact Information

For replacement decals, questions, or to order parts, contact your local dealer / distributor.

If a local dealer cannot be found, contact Ogden Metalworks.

Ogden Metalworks Inc.
PO Box 128
301 N. Marilyn Avenue
Ogden, IL 61859

PH: 217-582-2552

Fax 217-582-2746

www.ogdenmetalworks.com

11.2 Wheel Rake Frame

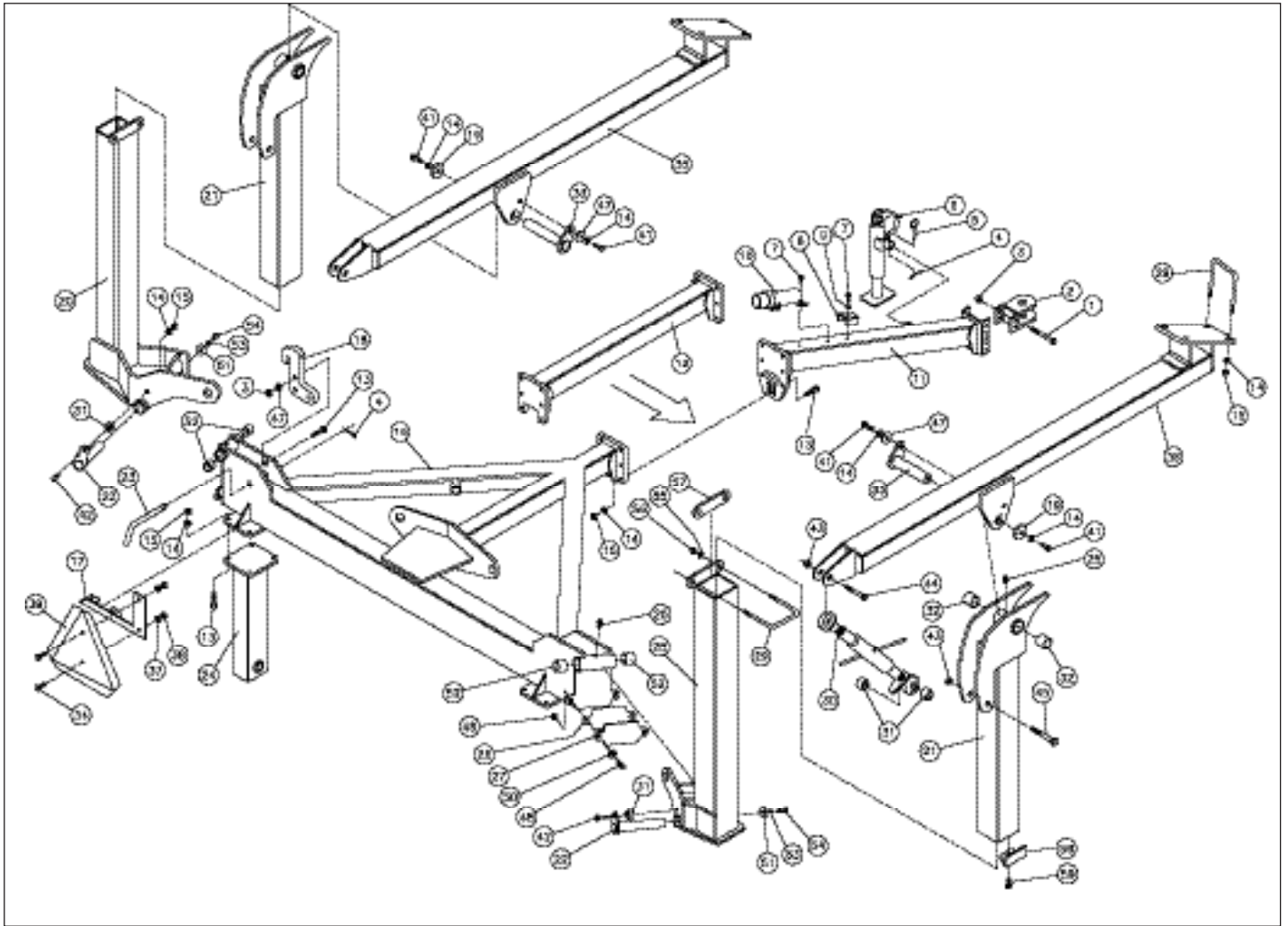

Item	Part Number	Description	Qty.
1	HRH587	Hex Capscrew, 5/8" x 7"	2
2	HR100	Clevis	1
3	HRH580	Nylock Hex Nut, 5/8"	2
4	0-56	Hairpin Clip, 2 15/16" x 5/32"	3
5	HP58-3	Pin, 5/8" x 3"	1
6	0-51	Jack Stand	1
7	K-326	Hex Capscrew, 3/8" x 1"	4
8	HR192	Hose Holder	2
9	K-308	Lockwasher, 3/8"	3
10	MH	Manual Holder	1
11	RCR11	Tongue Weldment	1
12	RCRT	Tongue Extension Weldment	1
13	0-156	Hex Capscrew, 5/8" x 2"	20
14	OE-155	Lockwasher, 5/8"	24
15	OE-154	Hex Nut, 5/8"	22
16	RCR16	Center Weldment	1
17	HR112	SMV Bracket	1
18	RCR18	Wing Transport Lock	2
19	HR190	Pin Retainer 1-1/4"	2
20	RCR20L	Wing Weldment (Left)	1
21	RCR21	Wing Extension Weldment	2
22	RCR22	Hinge Pin Weldment	2
23	H58-5B	Pin, 5/8" x 5" Bent	2
24	RCR15	Axle Weldment	2
25	VM-605	Grease Zerk, 1/4"	4
26	CRS16GA	Shim Plate	4
27	CRBP14	Bumper Plate	2
28	RCR20R	Wing Weldment (Right)	1
29	H34-4-534UB	U Bolt, 3/4" x 4" x 5-3/4"	6

Item	Part Number	Description	Qty.
30	TB22507	Turnbuckle	2
31	CR31	Bushing, 1" x 9/16"	6
32	VM-604	Flange Bushing, 1-1/4" x 1-1/4"	4
33	RCR33	Pivot Pin Weldment	2
34	K-334	Hex Capscrew, 1/4" x 1"	2
35	RCR35L	Lift Arm Weldment, Left	1
36	RCR35R	Lift Arm Weldment, Right	1
37	K-335	Lockwasher, 1/4"	2
38	K-336	Hex Nut, 1/4"	2
39	SMVS	SMV sign	1
41	H58-114	Hex Capscrew, 5/8" x 1-1/4"	2
42	HRH5825	Hex Capscrew, 5/8" x 2-1/2"	2
43	H34NL	Nylock Hex Nut, 3/4"	4
44	H34-4	Hex Capcscrew, 3/4" x 4"	2
45	H34-5	Hex Capcscrew, 3/4" x 5"	2
47	HRH58SF	Flatwasher, 5/8" SAE	2
48	H38-112	Hex Capscrew, 3/8" x 1-1/2"	4
49	HRH380	Nylock Hex Nut, 3/8"	4
50	H38FWUSS	Fender Washer, 3/8" USS	4
51	HR210	Pin Retainer, 1-3/4"	2
52	HRBF175-150	Flange Busing 1-3/4" x 1-1/2"	4
53	H34LW	Lockwasher, 3/4"	12
54	H34-114	Hex Capscrew, 3/4" x 1-1/4"	2
55	H34W	Washer, 3/4"	4
56	H34HN	Heavy Duty Nut, 3/4"	4
57	RCR57	U Bolt Spacer	2
58	CR22	Slide Plate	8
59	H12-1	Hex Capscrew, 1/2" x 1"	8
60	HNW	Heavy Nut Wrench	1

11.3 Hinged and Standard I-Series Assembly

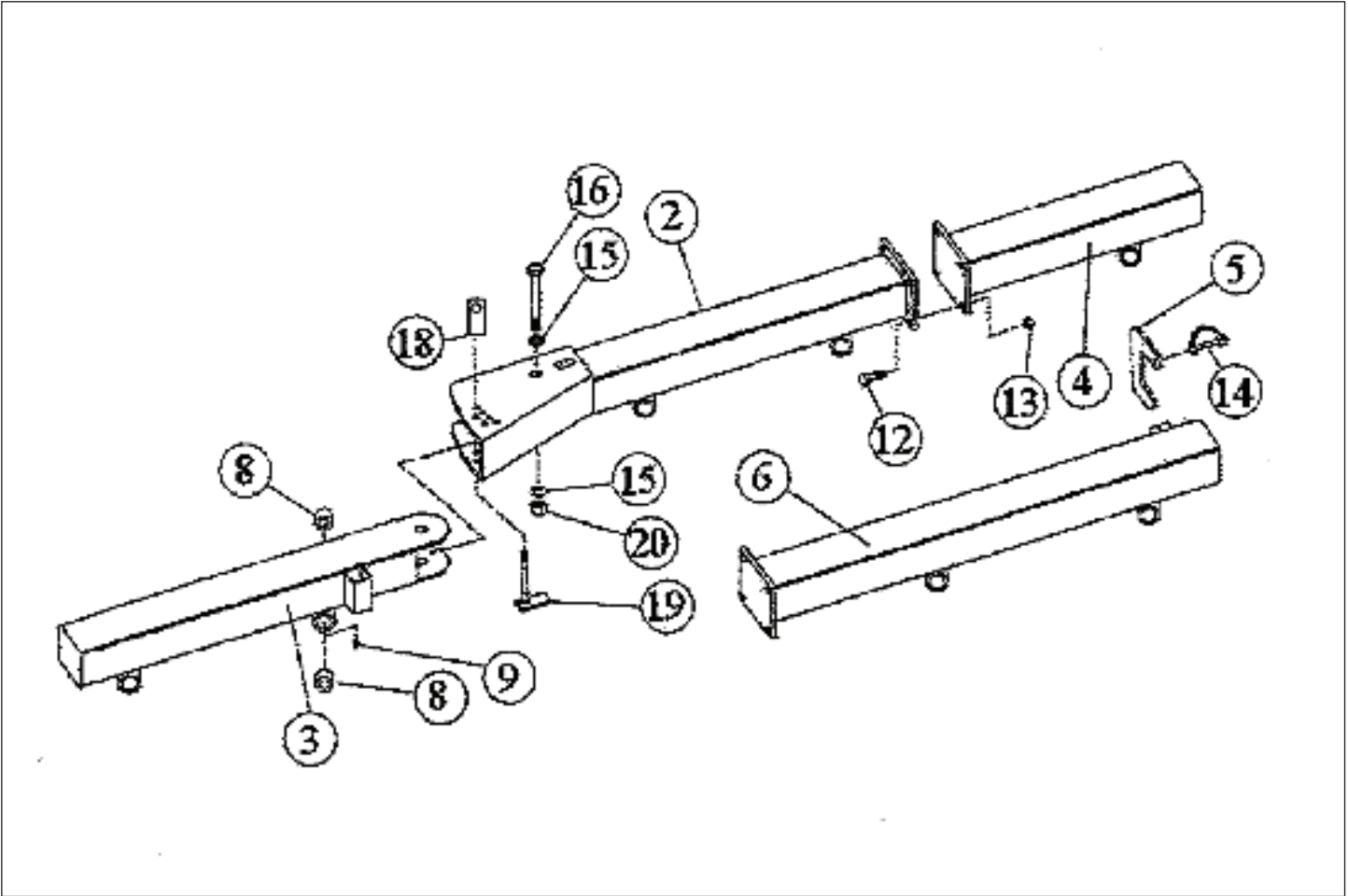

Item	Part Number	Description	Qty.
2	HR215 HR217	4 Wh I Series Front, RH 4 Wh I Series Front, LH	1
3	HR216 HR218	4 Wh I Series Rear, RH 4 Wh I Series Rear, LH	1
4	HR219 HR220	Single Rake Arm Extension, RH Single Rake Arm Extension, LH	1
5	HR224	Clip, Front Wheel	2/4
6	HR221 HR222	2 Wh Rake Arm Extension, RH 2 Wh Rake Arm Extension, LH	1
8	HRB125	Bushing	*
9	VM-605	Grease Zerk, 1/4"	*
10	OE-154	Hex Nut, 5/8"	*

Item	Part Number	Description	Qty.
11	OE-155	Lockwasher, 5/8"	*
12	HRH12150-8	Hex Capscrew, 1/2" x 1 1/2" GR8	*
13	0-161	Nylock Nut, 1/2"	*
14	21992	Wirelock Pin, 3/8"	*
15	HRH58SF	SAE Flatwasher, 5/8"	*
16	HRH586	Hex Capscrew, 5/8" x 6"	*
18	H58HN	Heavy Duty Nut, 5/8"	*
19	CR26	Adjustment Pin I-series RCR	*
20	HRH580	Nylock Nut, 5/8"	*

* As Required

11.4 Rake Wheel Assembly

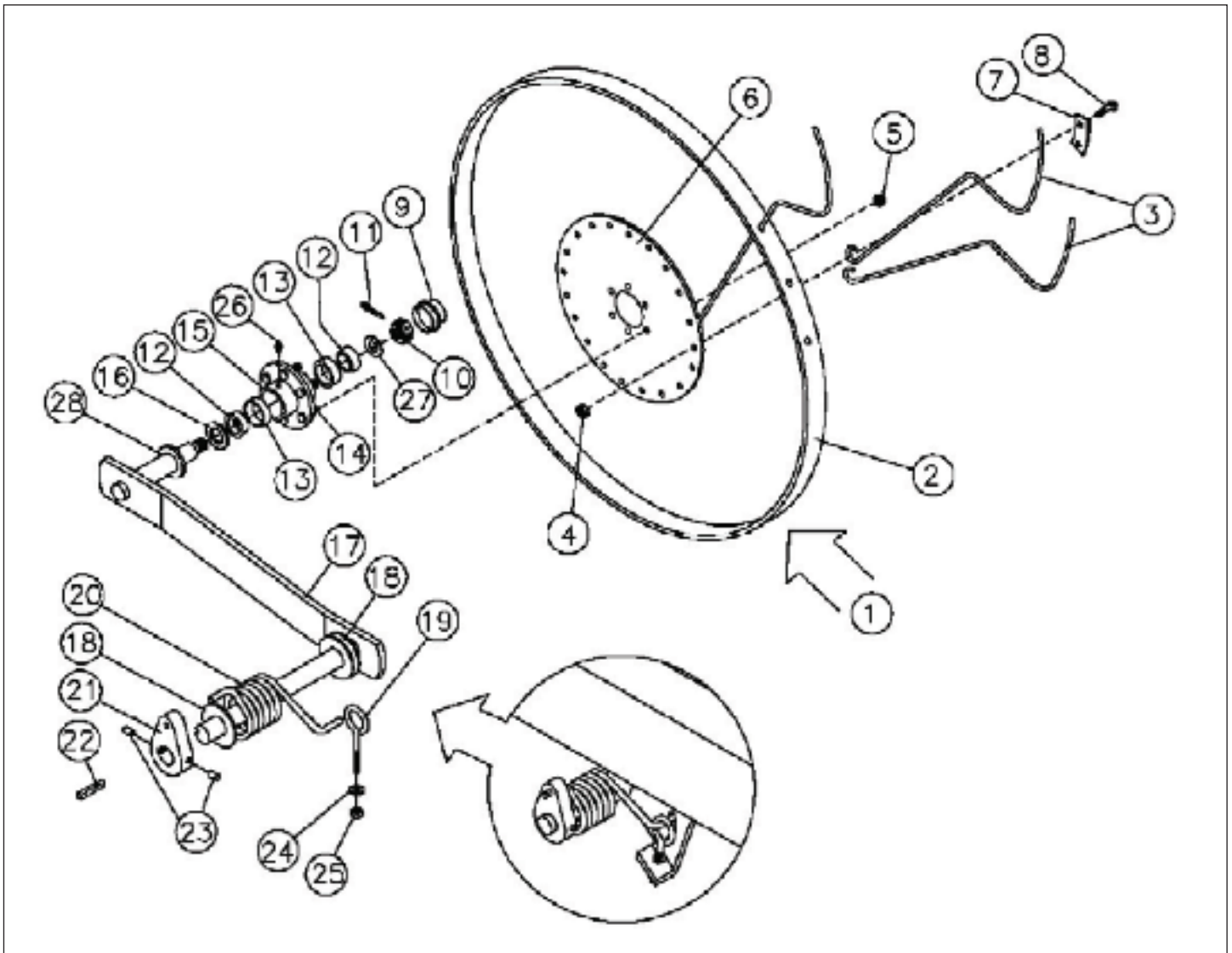

Item	Part Number	Description	Qty.
1	HR118 HR119 RW60RH RW60LH	Rake Wheel Complete, 55" RH Rake Wheel Complete, 55" LH Rake Wheel Complete, 60" RH Rake Wheel Complete, 60" LH	*
2	HR120 RCROR	55" Rim 60" Outer Rim	
3	HR121 RCRT	Rake Tine, 7mm (55" wheel) Rake Tine, 7.5mm (60" wheel)	
4	HR122	Hex Nut, M10	
5	HR123	Hex Flange Nut, 3/8"	
6	HR124 RCR60F	Flange 55" Wheel Flange 60" Wheel	
7	HR125	Tine Clamp	
8	RP000369	Carriage Bolt, M10 x 25	
9	909176	Hub Cap	
10	953005	Hex Castle Nut, 1" -14	
11	909454	Cotter Pin, .15" x 1.5"	
12	910253	Bearing Cone, L44649	
13	910250	Bearing Cup, L44610	
14	3819	Stud 3/8"	

Item	Part Number	Description	Qty.
15	105026C	Hub Complete	
16	906282	Seal	
17	HR150	Rake arm with welded in spindle/hub	
18	VM-719	Machine Washer, 1-1/4" 18 ga.	
19	VM-609	Eye Bolt, 3/8" x 3-1/2"	
20	VM-607	Torsion Spring, RH	
20	VM-608	Torsion Spring, LH	
21	HR152	Spring Block	
22	HR151-2	Woodruff Key, 1/4" x 3/4"	
23	VM-718	Set Screw, 3/8" x 1/2"	
24	MCH38F	Flatwasher, 3/8"	
25	HN38	Hexnut, 3/8"	
26	M61	Grease Zerk, M6	
27	913576	Washer	
28	N807-P	Seal Protector	

11.5 Single and Tandem Axles

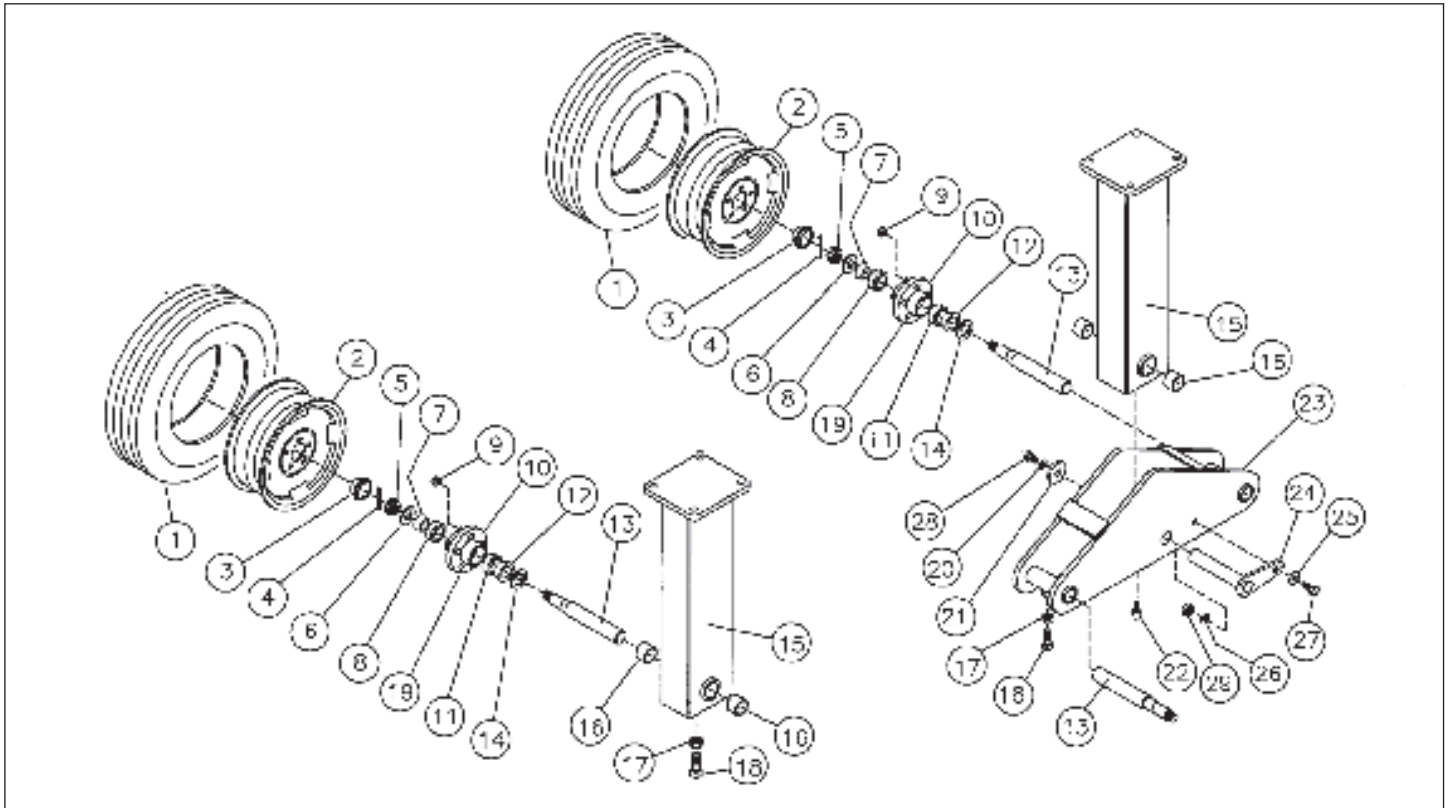

Item	Part Number	Description	Qty.
1	HR117	Tire	2
2	HR133	Wheel	2
3	909900	Dust Cap	2
4	905936	Cotter Pin	2
5	953005	Hex Castle Nut	2
6	951801	Flat Washer	2
7	910253	Outer Cone	2
8	910250	Outer Cup	2
9	912919	Wheel Nut, 1/2"-20	2
10	280090	Hub Complete	2
11	910251	Inner Cup	2
12	910252	Inner Cone	2
13	286929L14	Spindle	2
14	906281	Grease Seal	2
15	RCR15	Axle Weldment	2
16	HRB175-150	Bushing, 1-3/4" x 1-1/2"	4
17	0-179	Hex Jam Nut, 1/2"	2
18	0-178	Setscrew, 1/2" x 1-1/2"	2
19	953002	Wheel Stud, 1/2"-20 x 1-7/8"	10

* As Required

Item	Part Number	Description	Qty.
1	HR117	Tire	4
2	HR133	Wheel	4
3	909900	Dust Cap	4
4	905936	Cotter Pin	4

Item	Part Number	Description	Qty.
5	953005	Castle Nut	4
6	951801	Flat Washer	4
7	910253	Outer Cone	4
8	910250	Outer Cup	4
9	912919	Wheel Nut, 1/2"-20	4
10	280090	Hub Complete	4
11	910251	Inner Cup	4
12	910252	Inner Cone	4
13	286929L14	Spindle	4
14	906281	Grease Seal	4
15	RCR15	Axle Weldment	2
16	HRB175-150	Bushing, 1-3/4" x 1-1/2"	4
17	0-179	Hex Jam Nut, 1/2"	4
18	0-178	Setscrew, 1/2" x 1-1/2"	4
19	953002	Wheel Stud, 1/2"-20 x 1-7/8"	20
20	H34LW	Lockwasher, 3/4"	2
21	HR210	Washer	2
22	GZB12-12	Grease Zerk Insert	2
23	CRTA1	Tandem Weldment	2
24	CRTA2	Pin Weldment	2
25	HRH58SF	Flat Washer, 5/8" SAE	2
26	OE-155	Lockwasher, 5/8"	2
27	HRH58175-8	Hex Capscrew, 5/8" x 1-3/4" GR8	2
28	HRH34125	Hex Capscrew, 3/4" x 1-1/4"	2
29	OE-154	Hex Nut, 5/8"	2

11.6 Hydraulic System

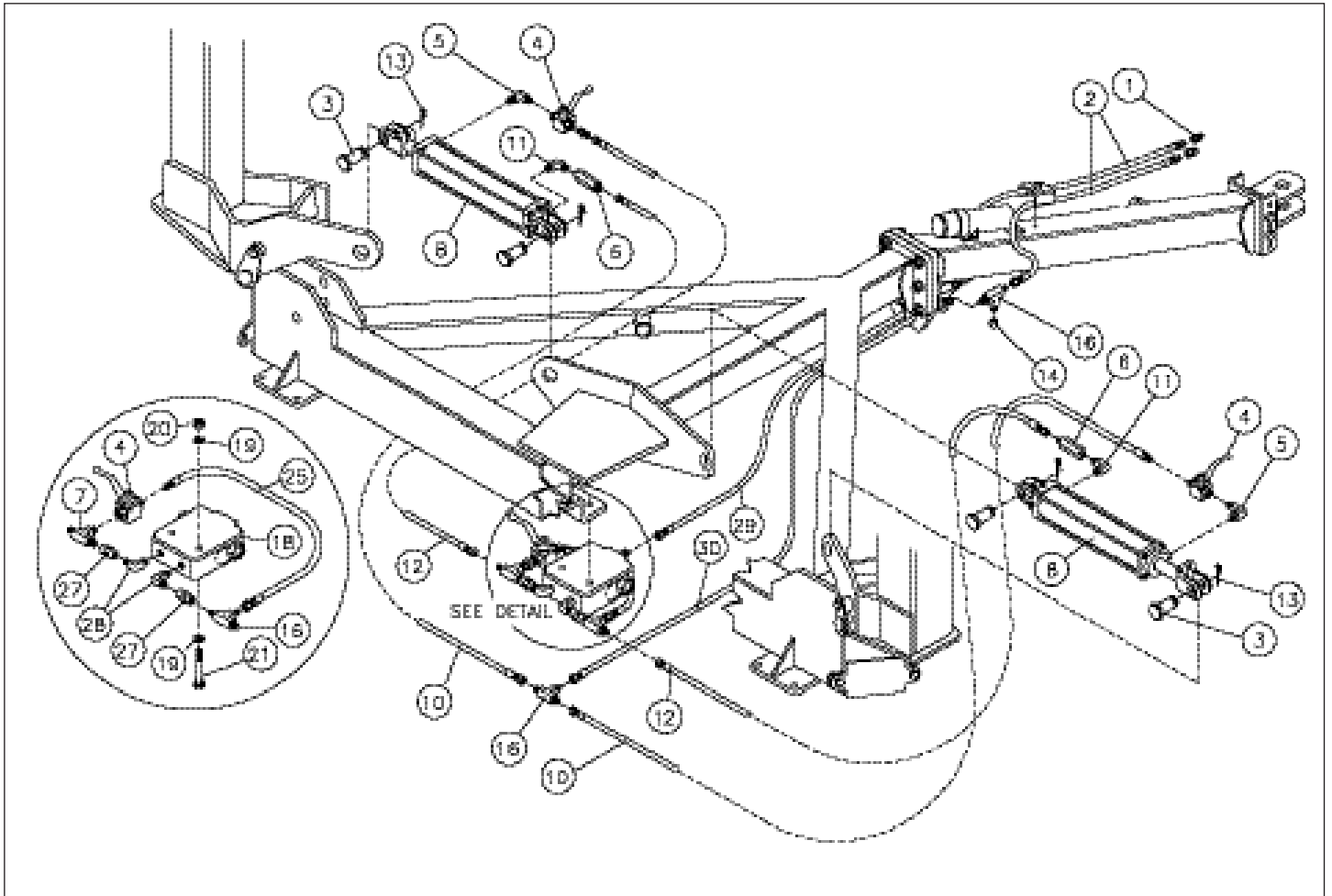

Item	Part Number	Description	Qty.
1	8010-15	Coupler, Male 8FB	2
2	CR201	Hose, 3/8" x 142" 8MB-8MJX	2
3	HR128	Cylinder Pin, 1" x 2-3/4"	4
4	WBV2-SAE8	Shut Off Valve, 1/2" 8MB	3
5	8MB-8MB90	Elbow, 90	2
6	PM-R-12	Restrictor	2
7	8MJ-8MJ-8MB	Tee	1
8	662401 649206	Cylinder, 3" x 12" SAE8 Seal Kit	2
10	CR202	Hose, 3/8" x 20" 8MJX-8MP	2
11	8MB-8MP90	Elbow, 90	2
12	CR203	Hose, 3/8" x 25" 8MJX-8MB	2
13	CP316-214	Cotter Pin, 3/16" x 2 1/4"	4
14	8FJ-CAP	Cap	2
16	8MJ-TEE	Tee	3
18	HC-V-CB20	Flow Divider	1
19	FW14	Flatwasher, 1/4"	2
20	HRH140	Nylock Hex Nut, 1/4"	2
21	HRH143	Hex Capscrew, 1/4" x 3"	2
25	CR205	Hose, 3/8" x 20" 8MJX-8MB	1

Item	Part Number	Description	Qty.
27	8FJX-8MB	Fitting	2
28	8MB-8FB90	Elbow, 90	2
29	CR204	Hose, 3/8" x 62" 8MB-8MJX	1
30	CR206	Hose, 3/8" x 62" 8MJX-8MJX	1

11.7 Center Wheel Assembly

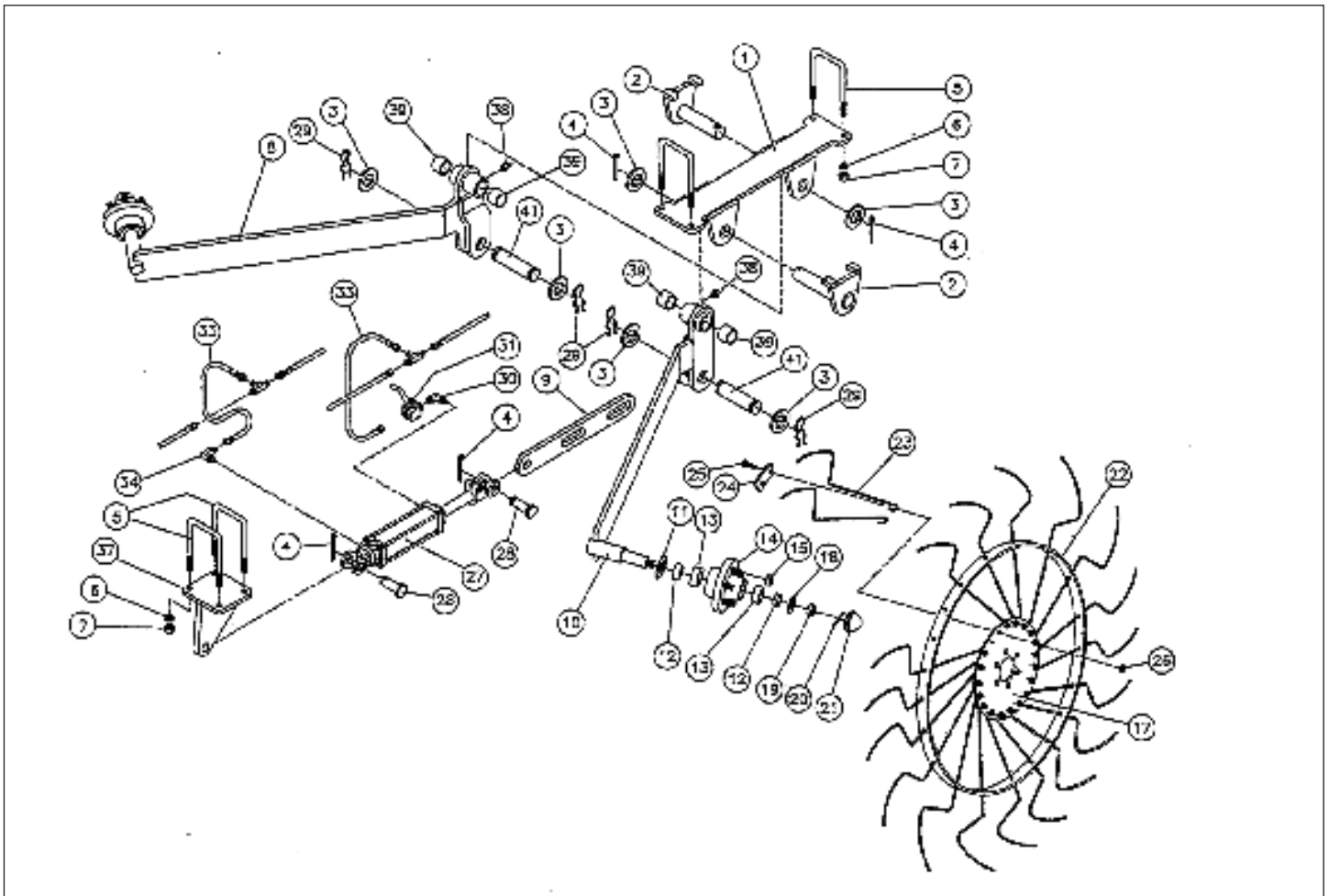

Item	Part Number	Description	Qty.
1	CR301	Mount Plate Weldment	1
2	CR302	Pivot Pin	2
3	H1FW	Washer, 1" SAE	6
4	CP316-2	Cotter Pin, 3/16" x 2"	4
5	H58-4-714UB	U Bolt, 5/8" x 4-1/16" x 7-1/4"	4
6	OE-155	Lockwasher, 5/8"	8
7	OE-154	Hex Nut, 5/8"	8
8	CR303L	Rake Arm (Left)	1
9	CR305	Linkage Arm	1
10	CR303R	Rake Arm (Right)	1
11	906282	Seal	2
12	910253	Bearing Cone, L44649	4
13	910250	Bearing Cup, L44610	4
14	105026C	Hub, complete	2
15	HR123	Hex Flange Nut, 3/8"	12
17	HR124	Flange	2
18	912576	Washer	2
19	953005	Hex Castle Nut, 1"	2
20	909454	Cotter Pin, .15" x 1.5"	2
21	909176	Hub Ca	2

Item	Part Number	Description	Qty.
22	HR118 HR119	Rake Wheel Complete, RH Rake Wheel Complete, LH	1 1
23	HR121	Rake Tine, 7mm	80
24	HR125	Tine Clamp	10
25	RP000369	Carriage Bolt, M10 x 25	20
26	HR122	Hex Nut, M10	20
27	W200060-S PMCK-W200000	Cylinder, 2" x 6" SAE6 Seal Kit	1
28	HR128	Cylinder Pin, 1" x 2-3/4"	2
29	50892	External Clip	4
30	6MB-6MB90	Elbow, 90	1
31	WBV2-SAE6	Shut Off Valve, 3/8"	1
33	CR308	Hose, 3/8" x 18" 6MJX-6MB	2
34	6MB-6FB90	Elbow, 90	1
37	CR307	Cylinder Mount Weldment	1
38	VM-605	Grease Zerk, 1/4"	2
39	16TB16	Bushing, 1" x 1"	4
41	10200	Linkage Pin	2

12. Warranty

Ogden Metalworks, Inc. warrants this product to be free from defects in material and/or workmanship under normal use and service for one year from the date of delivery by the dealer to the original purchaser. This warranty is only applicable if the unit is set up and operated as intended under normal service and in accordance with the instruction manual. Ogden Metalworks, Incorporated's obligation under this warranty is limited to the replacement of any part or parts which are determined defective by Ogden Metalworks, Inc. due to factory workmanship and/or material. Parts or components, if requested by Ogden Metalworks, Inc., must be returned through the selling dealer or distributor directly to Ogden Metalworks, Inc. with all transportation charges prepaid, for inspection and determination of warranty. This warranty does not cover common wear items or component parts not manufactured by Ogden Metalworks except to the extent of their manufacturer's warranties. This warranty does not cover, under any circumstances, any parts, components, or materials which have been subjected to neglect, misuse, alteration, accident or if repaired with parts other than those manufactured by and obtained from Ogden Metalworks, Inc. Credit for required labor will be issued at the company's discretion.

This warranty is extended solely to the original purchaser and is not transferable. This warranty is not valid unless the warranty card has been returned to Ogden Metalworks, Inc. within 30 days from the date of purchase by the end user.

Ogden Metalworks, Inc. reserves the right to change specifications and dimensions without notice.

The warranty will not be valid unless card is mailed to:

***Ogden Metalworks Inc.
PO Box 128
Ogden, IL 61859***

***or faxed to:
217-582-2746***

RCR812 Hay Runner Warranty Card	
Please print Purchased Date _____	
Name _____	
Address _____	
Address _____	
Serial Number _____	Model _____
Dealer _____	
Address _____	

NOTES

NOTES

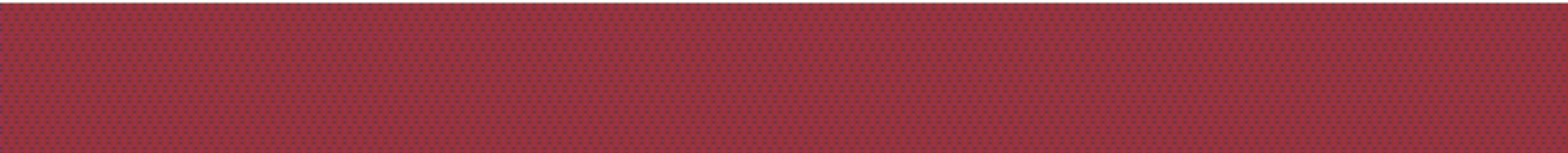

Manufactured by:
Ogden Metalworks Inc.
PO Box 128 ◊ 301 N. Marilyn Avenue
Ogden, IL 61859
PH: 217-582-2552 ◊ Fax 217-582-2746
www.ogdenmetalworks.com

