



2025

PRODUCT CATALOG

C
A
T
A
L
O
G
2
0
2
5

WRAPPERS
INLINE & SINGLE BALE



HAY MERGERS



SELF LOADING
SQUARE BALE TRAILERS



TMR MIXERS



SELF LOADING
ROUND BALE TRAILERS



FIELD THE BEST



TABLE OF CONTENTS

BELT MERGERS

OUR PRODUCTS	6
WHAT SETS US APART	8

INLINE WRAPPERS

OUR PRODUCTS	25
WHAT SETS US APART	27
UNMATCHED RELIABILITY	29
NWS720	30
IFX720 XTRACTOR	31
HYBRID X XTRACTOR	32
EVOLUTION XTRACTOR	33
FUSION720 XTRACTOR	34

INDIVIDUAL WRAPPERS

OUR PRODUCTS	41
BUILT ACCORDING TO YOUR NEEDS	43
RB200	44
RB500	45
RB600 AND RB600E	46
RB580	47
590HS	48
680HS	49
800HS	50
ELLIPSE 660	51

ACCESSORIES

MODEL 4000	56
MODEL 5000	56
MODEL 6000	57
BALE SPEARS	57
QUICK ATTACH	57

SELF-LOADING BALE MOVERS

ROUND BALE MOVERS

EFFICIENCY AND SPEED	60
UNPARALLELED POWER AND MANEUVERABILITY	63
TRB1000	64
RBM1000	65
RBM1400	66
RBM2000	67

ROUND BALE MOVERS FOR WRAPPED BALES

REAL TIME BALE COLLECTING!	73
WHAT SETS US APART	75
RBMPRO SERIES	76
RBMPRO 1400™	78
RBMPRO 2000™	79

ALL-IN-ONE SYSTEM (WRAPTOR)

EFFICIENTLY TRANSPORT AND WRAP WITH THE WRAPTOR!	85
IT IS BOTH WRAPPER AND BALE MOVER	87
WRAPTOR™	89

SQUARE BALE MOVERS

ANDERSON TOUGH!	93
THE STACKPRO SERIES, THE MOST PRODUCTIVE YET	95
STACKPRO5400	98
STACKPRO7200	99
TSR3450	102

BALE PROCESSOR

WHY USE A BALE PROCESSOR?	109
QUICK AND EASY DISTRIBUTION	111
PRO-CHOP 150	112

SMARTMIX™ VERTICAL TMR MIXERS

UNIQUE DESIGN	117
WHAT SETS US APART	119
STRENGTH AND LONGEVITY	121
UNLOADING METHODS	124
MORE FUNCTIONAL COMPUTER	125
HOW TO CHOOSE YOUR MIXER SIZE	126
A280	128
A380	129
A450	130
A520	131
A700	132
A920	133
A950	134
A1230	135

VERTICAL STATIONARY TMR MIXERS

UNIQUE DESIGN	145
WHAT SETS US APART	147
STRENGTH AND LONGEVITY	149
MORE FUNCTIONAL COMPUTER	151
S280	152
S380	153
S450	154
S520	155
S70	156
S920	157



POWERED by
HONDA™



INNOVATION AT THE CORE OF OUR BUSINESS



ANDERSON

FIELD THE BEST



Anderson worldwide

Only Anderson offers you better-thought-out agricultural solutions better designed to always do more and more easily. We work in hay logistics business segments, storage and feeding.

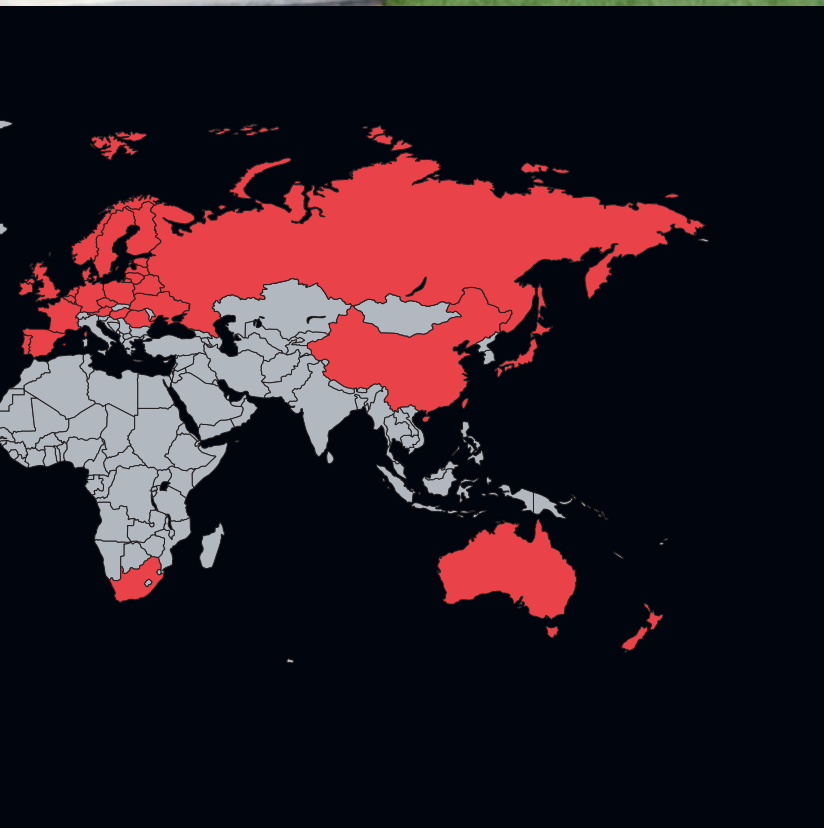

1988

Anderson Group has been manufacturing agricultural equipment to facilitate hay storage since 1988.

1995

In January 1995, the acquisition of a laser cutter improves quality and finish of our products.

2003

In February 2003, Anderson Group acquires a manufacturer of log loaders and individual wrappers in order to expand their product line.

2005

In 2005, Anderson Group develops a self-loading bale carrier for round bales. One man and one tractor can load and haul up to 20 bales at a time.

2007

The Wraptor™ is launched. An all in one equipment for hauling and wrapping hay. This system lets one man and one tractor get the job done.

2009

In September 2009, Anderson Group introduces the Biobaler. It can harvest most biomass and compact it into a 4' x 4' bale.

2013

Today, Anderson Group has over 120 employees. The factory is 87,000 sq ft. Anderson continues to add more products to its line-up to better meet the needs of farmers and global trends.

2015

The first STACKPRO7200 is built, a trailer that allows the collection and stacking of square bales vertically.

2016

The introduction of The PRO-CHOP 150 bale processor is introduced in the market, for both straw chopping and distributing forages.

2017

In an effort to constantly innovate, Anderson adds to its range of products the TMR vertical mixers Smartmix™.

2018

The new RBMPRO 2000 solves the problem of being able to pick up, transport and unload coated bales directly from the field. Unique design to Anderson!

2019

Continuous improvement and innovation makes Anderson launch 6 new products : STACKPRO5400, RBM1400, RBM2000, 800HS, IFX720,590HS and 680HS.

2020

Anderson unveils the very first wrapper capable of in-line and individual wrapping with a single machine: the Fusion720 Xtractor.

2023

Anderson launches a New product : the MERGEPRO belt merger





ANDERSON

MERGEPRO BELT MERGER



MERGEPRO Belt merger

PERFECT SWATH CONSISTENCY

Adaptive TRUE-GROUND speed technology

The rotation speed of the pick-up and the belt adjusts in relation to the forward speed of the tractor. This ensures a perfect windrow formation which facilitates and accelerates the speed of picking up the crop.

Fastest working speed

Camless pickup for maximum working speed and reduced maintenance - Working speed from 0 to 18 mph (0-28 km/h)* (refer to spec page) without loss of quality

Front roller and deflector

Ensures hesitation-free pick-up of material and consistent throwing onto the belt for consistent swaths.



Multiple crop delivery options

With the reversible rotation of the belts, the location of the windrows can be carried out in many ways. See p.12 to see the unloading possibilities.

Camless 6 rows pickup reel

The simplified design of our system with six rows of teeth, allows us higher rotation speeds than a cam system. With fewer moving parts, this one-piece construction ensures greater strength, better reliability and lower maintenance costs

Curved tines

The reverse curve tines utilize the inertia generated by forage movement, ensuring smooth flow and keeping the pickup clean. This design lifts forage while leaving unwanted elements (stones, slurry, etc) in the field. Unlike other brand's tines that damage plants upon ground contact, the MergePro's tines glide over the surface, minimizing plant disturbance.



THE ADVANTAGES OF A **CAMLESS** DESIGN

The 6-row camless pickup system has far fewer components, therefore offers higher working speed and less maintenance. Simple rotation, no additional moving parts, no additional wear. Compact, robust, reliable and simple. Why complicate things when they can be so simple?

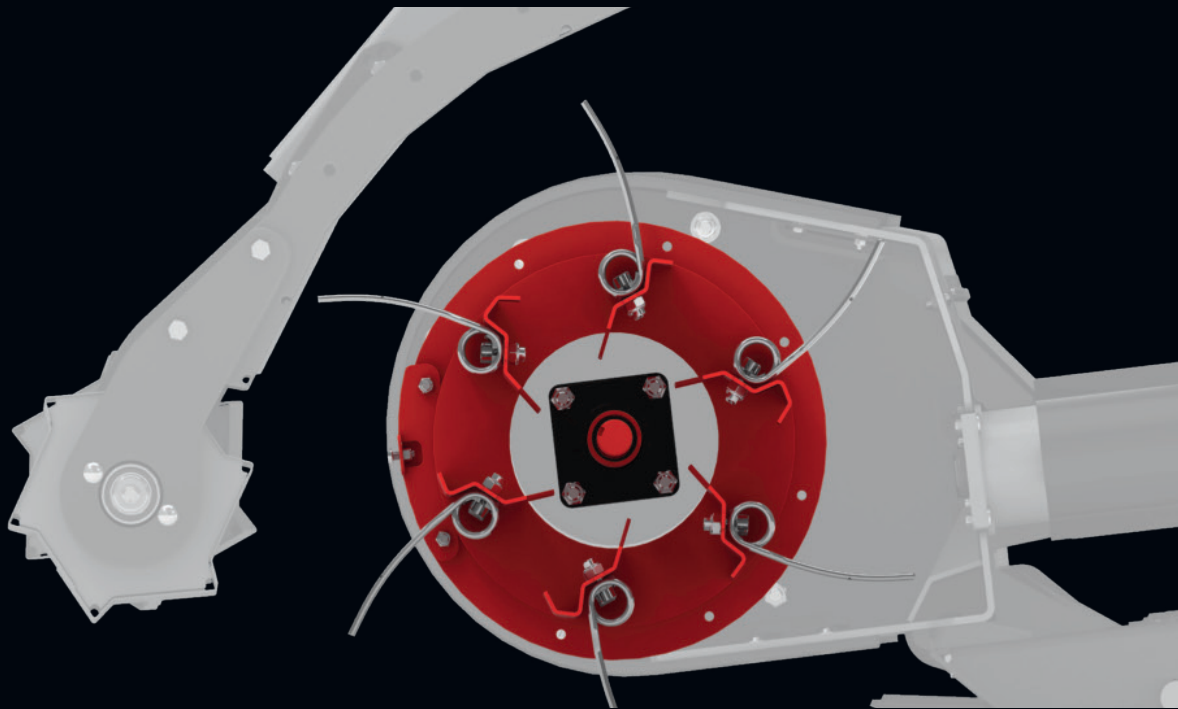

NEW

THE NEW **BELT STOP** FEATURE

The **BELT STOP** feature allows the operator to stop the ejection of material from the belt while the pickup is still rotating. Very useful in tight spaces, this feature allows the operator to accumulate the forage and place it in a place where the windrow will be easier to access for the harvesting machine.



CANADIAN MODEL SHOWN



Adaptive “True Ground speed” technology

This truly unique feature to the MERGEPRO allows the pickup and belt to be constantly monitoring the ground speed and adjusting themselves to deliver constant and equal crop on the belt as you go insuring consistent swath. (Can also be run on “Manual” mode using a fix working speed.)



Fastest working speed on the market

MERGEPRO’s camless pickup for maximum working speed and reduced maintenance - Working speed from 0 to 18 mph without loss of quality (0-28 km/h *refer to specification pages) .



YOU ASKED

WE DELIVERED



Compaction of the field

The large contact surface of the pads guarantees a smooth glide. Even on soft and wet grounds, the width of the skis distribute the weight evenly on the ground. Combined with our hydraulically adjustable suspension, the weight and ground pressure of the collection units is always optimal. The responsiveness of the suspensions ensures perfect ground following while having a damping effect. All of this technology protects both your equipment and your field.

Equivalent weight on ground

1 person 200lbs

1 mergepro skid shoe

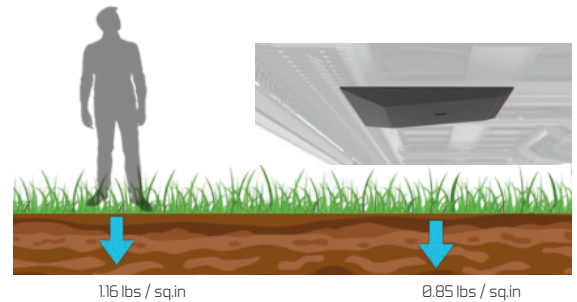

6 rows pickup reel

The six-row camless pickup of the MergePro ensures continuous material flow from ground to belt, unlike cam pickups that slow down forage in its critical transition phase, requiring constant intake of new material to push through, leading to blockages.

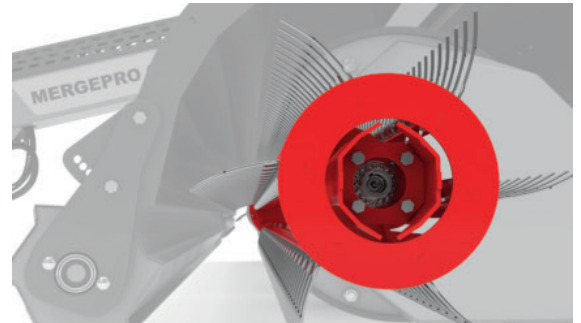

Deflector above pickup and belt

The forage deflector above the pickup restricts turbulence during material movement from the ground to the belt without hesitation, ensuring consistent forage flow and unmatched windrow consistency. Eliminating turbulence with a deflector ensures a steady flow to the belt, essential for producing easy-to-harvest windrows.

In short fiber crops often encountered in 3rd or 4th cuts, the deflector ensures no material is left on the ground, maximizing nature's yield.





MULTIPLE CROP DELIVERY OPTIONS

CLOSED CONTINUOUS PICKUP

Mergepro 915 : 25' or 7.62m
 Mergepro 1060 : 30' or 9.15m

On the right side only

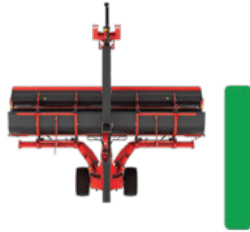

On the left side only

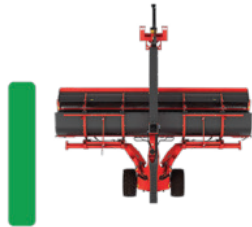

Both left and right sides



OPEN SPLIT PICKUP

Mergepro 915 : 30' or 9.15 m
 Mergepro 1060 : 35' or 10.60 m

Center only

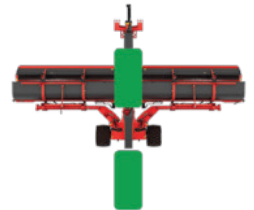

Center and right side

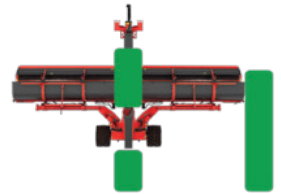

Center and left side

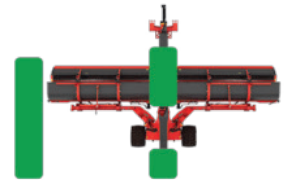

Both left and right sides



Mergepro models allow you to switch from side delivery to central delivery without tools. These mode changes are made from the tractor cabin effortlessly. Depending on the forage yield conditions, it will be easy for you to find an unloading configuration that best suits your harvesting machine. Versatile and fast, the Mergepro adapts to your needs.



HYDRAULIC PISTON MOTOR DRIVEN BELT

Hydraulic piston motor is able to run at a high speed of up to 1300 rpm and transport large quantities of forage quickly off the belt. This system is unique to Anderson and is stronger and faster than what is found in all other brands of mergers that run at a max speed of 800 rpm. This system allows Anderson to operate in the highest of yields and operate fast enough to prevent clumping, plugging and inconsistent swaths.



ADJUSTABLE GAIN

WHEN THE MACHINE IS USED IN AUTOMATIC MODE, THE ROTATION OF THE PICKUP AND THE BELTS ADJUSTS ACCORDING TO THE FORWARD SPEED OF THE TRACTOR. DEPENDING ON THE CONDITIONS ENCOUNTERED, THE OPERATOR MAY WANT TO MODIFY THIS SPEED ARRANGEMENT. THE MERGEPRO IS THE ONLY MERGER WHOSE GAIN CAN BE ADJUSTED. GAIN IS A TOOL THAT ALLOWS US TO INCREASE OR DECREASE THE PREDETERMINED SPEED AUTOMATICALLY ON THE PICKUP AND BELTS. IN THIS WAY, YOU CONTINUE TO BENEFIT FROM THE ADAPTIVE SPEED OF THE MACHINE WHILE MAINTAINING FULL CONTROL OVER THE FORMATION OF YOUR WINDROW.



CANADIAN MODEL SHOWN



LOADED WITH TECHNOLOGY

With the in-cab monitor, you can optimize machine performance and control features easily. The colorful, intuitive display provides real-time operation and diagnostic information. While technology simplifies our lives, we know electronic issues can disrupt critical workdays. That's why the MergePros can operate manually, ensuring you can complete your tasks regardless of electronic failures. At Anderson, we prioritize your machine's reliability.





Non-slip performance Belt Conveyors

Other brand's PVC belts offer poor traction for drive pulleys and struggle in wet or dense conditions, while the MergePro's genuine rubber belts ensure durability and traction, completing fields regardless of obstacles.

The quick-release belt tensioning system simplifies storage and routine adjustments. Easy adjustment on one side helps maintain even pressure across the width of the belt.



Narrow and simple transport

For the same raking width as a rotary rake, belt mergers are much more compact in size, making them much easier to use and store. Since the tag axle is closer to the tractor, the turning radius is much shorter. This advantage allows us to maneuver in tight places much more easily.



Teflon skid shoe protection

This option allows you to add a high resistance teflon plate coating to the skid shoes which limits the creation of sparks in soils containing steel and other material like it. The replaceable pads provide an extra layer of protection to prevent wear on the skid shoes.



WHAT SETS US APART

WHEN COMPARING OTHER RAKE SYSTEMS

Choosing a hay rake for your farm operation can seem like a daunting task. The choices for hay rakes are many. Different regions of the country seem to prefer different styles of rakes. We will break down their similarities and differences so that you can make the most sensible investment for your hay production needs. The following chart summarizes the four major rake options and their best use:

BEST OPTION				
BETTER				
ADEQUATE/ LEAST FAVORABLE				
NOT RECOMMENDED				

	PARALLEL BAR RAKE	WHEEL RAKE	ROTARY RAKE	MERGER
Working speed				
Working width				
Leaf retention				
Windrow formation				
Dirt and Stone in Windrow				
Fast Drying				
All terrain ability				

Choosing a belt merger, what's in it for you?

- Cleaner, more fluffy and consistent windrows
- Time saving with the 28km/h high operating speed without loss of productivity
- Robust design to cope with the most extreme conditions
- Lower harvest costs
- Less wear reduces repair costs
- Less bad ash in windrow and no leaf losses = Higher protein content for best animal performances
- One machine for all harvesting systems
- Less damage to harvesters due to less rocks collected versus other raking systems



No clogging with Adaptive True Ground Speed technology Unique to Anderson Merpro

The Anderson MergePro adjusts the pickup and belt rotation speed according to ground speed, easily controlled with a fingertip on the machine monitor. Other brand of belt mergers frequently encounter clogging between the pickup and the material conveyor belt. Most mergers have fixed pickup speeds, causing issues with long fiber crops as the pickup speed doesn't match the machine's forward speed, leading to fiber tangling and accumulation between flexible pickup bands and the belt, initiating technical troubles. The Mergepro's technology is designed with your needs in mind! If the MergePro can't pick up a crop, no other brand can!

NEW

17

LIMITED
QUANTITIES

MERGEPRO1370

PRE ORDER YOURS NOW

Released summer 2026



NEW FEATURES

- MERGER 40 ft (12m) and 35' (10m)
- STEERING WHEELS FOR A BETTER TURNING RADIUS
- ADJUSTABLE WORKING ANGLE DIRECTLY FROM THE TRACTOR CABIN
- COMPLETELY AUTOMATED (LESS MECHANICS)
- 4 SEPARATE APRONS FOR BETTER FLOATION IN THE FIELD





ANDERSON

FIELD THE BEST



CANADIAN MODEL SHOWN

TECHNICAL SPECIFICATIONS



SPECIFICATIONS

	MERGEPRO915	MERGEPRO1060
Working width centre swath	30 ft (9.15 m)	35 ft (10.67 m)
Working width side swath	25 ft + 5ft swath (7.62 m + 1.52m swath)	30 ft + 5ft swath (9.15 m + 1.52m swath)
Swath width centre swath	4.6 ft (1.40m)	4.6 ft (1.40m)
Swath width side swath with swathboard	3 to 5 ft (0.91 to 1.52m)	3 to 5 ft (0.91 to 1.52m)
Number of pick-up units	2	2
Pick-up width (tine-to-tine)	12.5 ft (3.81m)	15 ft (4.57 m)
Transport width	8.3 ft (2.53m)	8.3 ft (2.53m)
Transport height	11.4 ft (3.47m)	11.4 ft (3.47m)
Transport length	27.6 ft (8.41 m)	30.1 ft (9.18 m)
Height in transport position (for shipping purpose)	10.4ft (3.17m)	10.4ft (3.17m)
Min power flat ground (12km/h- 8mph)	100 HP	100 HP
Min power flat terrain (28km/h -18mph)**	140 HP	140 HP
Min power all other type of terrain (28km/h-18mph)**	100 HP	100 HP
PTO requirement	13/8 Z21 1000 @ 800 RPM Standard configuration (PTO included) 13/8 Z6 540 @ 540 RPM compatible (PTO not included)	13/8 Z21 1000 @ 800 RPM Standard configuration (PTO included) 13/8 Z6 540 @ 540 RPM compatible (PTO not included)
PTO RPM and equivalent optimal working speed	800 RPM (from 0 to 28km/h) 540 RPM (from 0 to 18 km/h)	800 RPM (from 0 to 28km/h) 540 RPM (from 0 to 18 km/h)
Max working speed	18 mph (28 km/h)	18 mph (28 km/h)
Hydraulic	38 GPM @ 800 RPM (133 L/min @ 800 RPM) 26 GPM @ 540 RPM (98 L/min @ 540 RPM)	38 GPM @ 800 RPM (133 L/min @ 800 RPM) 26 GPM @ 540 RPM (98 L/min @ 540 RPM)
Conveyor belt hydraulic motor	High quality Hydraulic Piston Motor	High quality Hydraulic Piston Motor
Pickup hydraulic motor	Hydraulic motor @ 243 RPM @ 28 km/h (18 mph)	Hydraulic motor @ 243 RPM @ 28 km/h (18 mph)
Oil reservoir capacity	95 US gal (360 L)	95 US gal (360 L)
Oil type	TDH	TDH
Oil Cooling system	Standard	Standard
Tires on transport chassis	560 / 45-22.5 RADIAL	560 / 45-22.5 RADIAL
Conveyor length	12.8 ft (3.9m)	15.2 ft (4.6m)
Conveyor width	36 in (0.92 m)	36 in (0.92 m)
Discharge capability	right left center	right left center
Conveyor direction control from tractor cab	yes	yes
Pickup height	0-3 in (7.2 cm)	0-3 in (7.2 cm)
Hitch	2 points Category 2 & 3	2 points Category 2 & 3
Electronic variable pickup speed control from tractor cab	Yes	Yes
Road lights and signaling	Yes	Yes
Required tractor hydraulic connections	2 outlets standard (3 if swathboard option)	2 outlets standard (3 if swathboard option)
Approximate machine weight	11 000 lb (5 000 kg)	11 750 lb (5 340 Kg)
Adjustable skid shoes	Standard	Standard
Comparing ground pressure:		
1 person weighing 90kg (200 lbs)	1.16 lbs / sq.in (0.081 kg/cm2)	1.16 lbs / sq.in (0.081 kg/cm2)
1 MergePro skid	0.85 lbs / sq.in (0.059 kg/cm2)	0.85 lbs / sq.in (0.059 kg/cm2)

**The operator must adjust the operating speed according to the type of forage and terrain



ANDERSON

HYBRID X



**SON
S
R
L
D
A**

INLINE WRAPPERS



POWERED by
HONDA™

BALEAGE 101

why and how

1) What is baleage?

Air tight, plastic wrapped, round or square bales of forage.

They are composed of:

- Fiber with a length of 10 to 13 cm (ideal for ruminants)
- 19% + average crude protein
- 30% to 60% humidity (45% is ideal)
- 65% of total digestible nutrients

2) Baleage advantages vs dry hay

- Larger harvesting window/capture more nutrients
- Reduced feed losses
- Speed up harvesting
- Increased milk production and Average Daily Gain (adg)
- Lower feed and labor costs
- Healthier animals

3) Poor storage practices

Poor storage practices can result in a 44% reduction in forage quality.

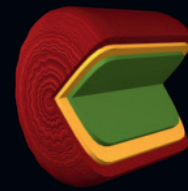

- Spoiled hay : 7.6 cm = 25 %
- Transition zone : 9 % decrease in dry matter intake
- Central zone : 56 % higher intake of dry matter

6) Effects of harvest stage on hay quality as well as animal weight gain*

Increased milk production and average daily gain

		INGESTION OF DRY MATTER POUNDS / DAY	% OF DIGESTIBILITY	% OF PROTEIN	POUNDS OF FEED FED / POUNDS GAINED	HAY POUNDS / ACRES (1ST CUT)	POUNDS GAINED / DAY
HARVEST STAGE	Pre-flowering	13.0	68	16.8	10.1	1334	1.39
	Start of flowering	11.7	66	10.2	13.5	1838	0.97
	Maturity stage	8.6	56	7.6	22.5	2023	0.42

* Holstein heifers were used, the average weight: 500 pounds. Source: Monty Montgomery, University of Tennessee.

7) Quality feed = \$

Good quality feed allows you to increase milk or animal gain by 38%!

	QUALITY FEED		
	LOW	HIGH	DIFF
Protein	10%	17%	7%
TDN	49%	59%	10%
Lb milk/Ton	1894	2625	731
Lb milk/Acre	11,364	15,750	4,386
\$/Acre	1931\$	2677\$	745\$

* University of Wisconsin Milk 2000, based on forage production 6 tonnes / acre. Milk price 17.00 \$ / cwt

10) Round bale shape

- Make bales as uniform and dense as possible
- Limit the diameter of the bale to 137 cm
- Easier to pack
- Ensures better silage quality
- Eliminate waste

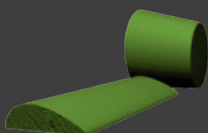

Width and shape uneven swath produces bales of unequal shapes.

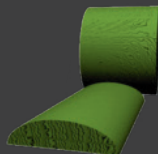

The width and shape of the equal swath produces bales of equal shapes.

11) Baling

Good moisture content :

- Silage : 40% to 60%
- Dry hay : less than 20%

Oxygen is expelled when it is carefully baled. Keep the nutrients inside, not the oxygen.

12) Baling guidelines

- A** Adjust the density of the baler at the maximum position
- B** Avoid using excessive speed.
- C** Make sure to produce uniform bales.

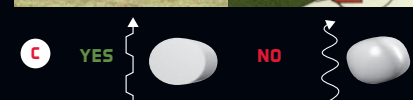



4) Reduction of feed losses

Studies of dry hay left in the field and losses during storage reveal at least 25 % wastage.

400 BALES NEEDED	NUMBER OF BALES
Bales produced	533
Loss in the field and storage (25 %)	133
Remaining bales after losses	400

Results: 533 bales LOST 133 LOST, it leaves you with 400 bales.

5) When to cut your crop?

Choose your harvest time to get:

- An optimal feed value
- Best resale value
- Additional Harvest time

Vegetative stage :

- Harvest at this point and get another harvest in 28 days

Reproductive stage:

- Harvest at this point and get another harvest in 42 days

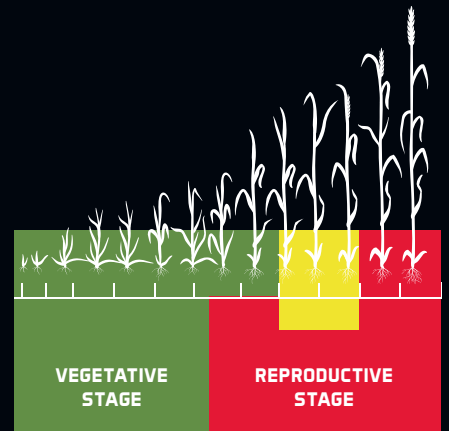

8) Feed

Feed accounts for 2/3 of overall costs. To lower overall costs, lower the cost of feed.

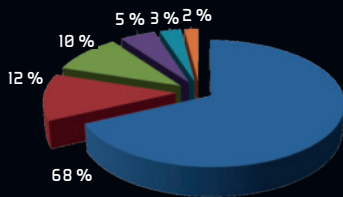

- Food including forage, cereals and concentrates
- Logistics, Sales and Administration Costs
- Veterinary and Reproductive Medicines
- Supplies for milk and improvement
- Cost of litter and housing
- Other direct charges and short-term interest

2004 AgCensus

9) Mowing

- Young plants
- New growth
- 3 to 4 cuts per season
- Cut from 10 to 13 cm from the ground after dew



13) Wrapping process

- On average within 6 hours of baling
- Wrap tightly with 6-8 layers of plastic to ensure a good barrier against oxygen
- Poor quality plastic equals poor results
- Run rows from north to south
- Consider a wrapper online or individual wrapper
- Production yields :
 - 100 à 150 bales / hour (in-line wrapper)
 - 35 à 65 bales/hour (individual wrapper)

14) Storage

Minimize bale damage during storage and transportation.

Bales stored:

- On a flat and smooth surface, free of vegetation and waste
- In a dry place to pick them up easily in winter and in wet weather near the feeding area
- Avoid storing near the forest or in remote areas

Label the bales according to the cutting period.



YOU ARE THE INSPIRATION
BEHIND OUR DESIGN AND MANUFACTURING



OUR PRODUCTS

They are constantly improving because we are listening to our customers and the real needs of their everyday life on the farm.

Anderson is developing its wrappers to ensure optimum wrapping quality. Our hydraulically adjustable compaction system is one of the features that sets us apart from the market standards. It provides a perfect coating for maximum nutrient conservation in each of your bales.



Make better crops

- Allows a larger harvest window of time
- Keeps more nutritional value by bale
- Reduces fodder losses
- Accelerate the harvest
- Reduces food and labor costs
- Produces healthier animals



POWERED by
HONDA

ANDERSON HYBRID X

WHAT SETS US APART

1) Mechanical and hydraulic system

Anderson's line of inline wrappers is designed with a mechanical and hydraulic system that is by far more reliable than electronic systems. It has an increased longevity and guarantees easy adjustments.

2) Speed and quality wrapping

The bale pusher is faster than ever with its improved integrated cylinders. It provides a wrapping of up to 180 bales per hour.

3) Autopilot

The autopilot allows the machine to move parallel to the adjacent row of bales to optimize the storage area. Free yourself from supervision during wrapping and save up to 20% space.

4) Flex Hoop technology

The Hybrid X XTRACTOR™ in-line wrapper is designed with advanced Flex Hoop technology to accurately wrap round and square bales with the same machine.

5) Large capacity hoop

All our models feature a large hoop to wrap 6 ft bales.

6) Compaction system

The hydraulically adjustable compaction system is the most important feature of an in-line wrapper, allowing the operator to put the right amount of braking on the hoop traction wheel to achieve perfect bale compaction.



XTRACTOR™ : patented and exclusive to Anderson

Our push-off system allows a quick and easy extraction of the last bale in less than a minute. A simple pull of a lever allows you to do everything. Only one step is needed to push the last bale. Anderson is the only manufacturer to offer you a fully automatic, effortless last bale pushing system.

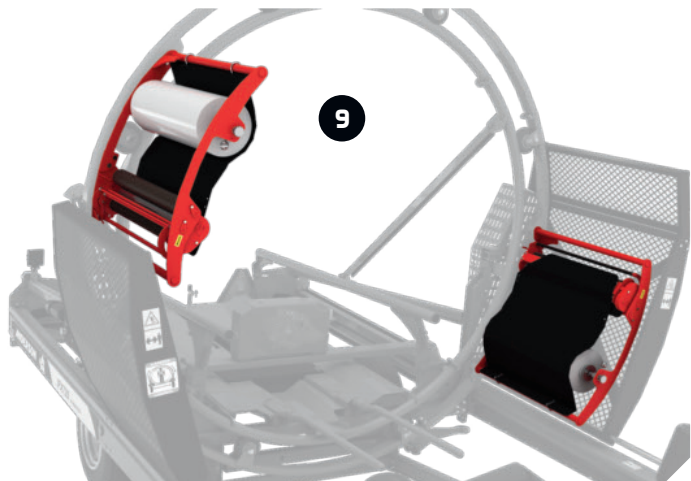

UNMATCHED RELIABILITY

Built with a simple mechanical and hydraulic system, they are also designed to offer you more than other wrappers. We are constantly innovating to make sure we stand out from the competition in the market.

1) Leveling system

Our hydraulic jack leveling systems or hydraulic lifting axles guarantee a high level of stability, whether you are on incline or in soft ground. Your wrapper will rise to the proper height to prevent the first bales from falling and hold them together to begin wrapping the row more easily.

2) Remote control

With remote control, do not leave the tractor seat and save operating time by starting, stopping and steering your wrapper remotely.

3) Work lights

For those of you who never stop, the work lights allow you to wrap in the evening and even at night,

4) Self-propelled

The self-propelled driving of our wrappers makes it possible to move the machine without the help of a trailer thanks to its self-propelled function. It allows you to position the wrapper in the field easily and, if necessary, transport it with two wheels on the ground from one field to another with ease.

5) Bale guide rollers

The two bale guide rollers hold each bale centered on the platform when wrapping on a slope.

6) Smart start

Allows wrapping at the beginning of the row without the bales sliding on the ground. Prevents damage to plastic. (Patent Pending)

7) Gas tank

We are aware of the importance of intervention costs during production shutdowns. Our long life tank reduces downtime and saves you time during your wrapping process.

8) Honda engine

The Honda engine offers high power, exceptional adaptability, quiet operation and high fuel efficiency.

9) Stretcher protective shield

The deflector prevents debris like corn stalk, straw or hay from getting into the tensioners and blocking them. (Patent Pending)

Our quality standards

- Independent aluminum tensioner system
- Wrapping speed of up to 180 bales per hour
- Plastic rolls change less often
- Increased bale tightness with the hydraulically controlled bale compacting system
- Overlapping plastic layers
- Plastic breakage detection system



Manual extraction system

Hydraulic axle

Large capacity hoop



NWS720

Model presented : Farm King Combo



Up to 6 ft (1,8 m) diameter
Up to 5 ft (1,5 m) length



Large capacity fuel tank
(24 L - 6,3 gal)



Wrapping speed
Up to 180 bales per hour

* Speed based on 4' bale wrapping.



Honda engine 13 HP



Hydraulic axle



Xtractor push off system



Remote control



IFX720 XTRACTOR

Model presented : Custom Operator Combo



Up to 6 ft (1,8 m) diameter
Up to 5 ft (1,5 m) length



Wrapping speed
Up to 180 bales per hour

* Speed based on 4' bale wrapping.



Large capacity fuel tank
(24 L - 6,3 gal)



Honda engine 13 HP

The specifications presented are specific to the models mentioned above. Please refer to the table on page 36-37.

POWERED by
HONDA™



Flex hoop technology



Xtractor push off system



Adjustable platform for square and round bales



HYBRID X XTRACTOR

Model presented: Custom Operator Combo



Up to 6 ft (1,8 m) diameter
Up to 5 ft (1,5 m) length



Wrapping speed
Up to 180 bales per hour
* Speed based on 4' bale wrapping.



3 ft x 3 ft (80 x 90 cm)
or 4 ft x 3 ft (90 x 120 cm)
Up to 6 ft (1,8 m) long



Large capacity fuel tank
(24 L - 6,3 gal)



Honda engine 13 HP (20 HP optional)

The specifications presented are specific to the models mentioned above. Please refer to the table on page 36-37

POWERED by
HONDA™



Large capacity hoop



Xtractor push off system



Autopilot system available



EVOLUTION XTRACTOR

Model presented : Evolution II Combo



Up to 6 ft (1,8 m) diameter
Up to 5 ft (1,5 m) length



3 ft x 3 ft (80 x 90 cm)
or 4 ft x 3 ft (190 x 120 cm)
Up to 6 ft (1,8 m) long
(wrap double stacked or single high bale)



Wrapping speed
Up to 120 bales per hour
* Speed based on 4' bale wrapping.



Large capacity fuel tank
(24 L - 6,3 gal)



Honda engine 20 HP

The specifications presented are specific to the models mentioned above. Please refer to the table on page 36-37.

POWERED by
HONDA™

FUSION XTRACTOR





Wrap inline and single bales with one machine!





FUSION720 XTRACTOR

Combination inline & single bale wrapper



Up to 6 ft (1,8 m) diameter inline wrapping/
Up to 5 ft (1,5 m) diameter individual wrapping
Up to 5 ft (1,5 m) length



Large capacity fuel tank
(24 L - 6,3 gal)



Wrapping speed
Up to 140 bales/hr (inline wrapping)
Up to 50 bales/hr (single bale wrapping)



Honda engine 13 HP

* Speed based on 4' bale wrapping.

The specifications presented are specific to the models mentioned above. Please refer to the table on page 36-37.

POWERED by
HONDA™

THE NEW FUSION720 XTRACTOR

Contractors will particularly appreciate this machine for its versatility to wrap inline as well as individual bales. Lets you optimize and diversify the customer base and increase turnover with a single equipment.

The Fusion720 Xtractor also solves the problem of row ends and losses caused by this system. Simply wrap a bale to create a start and end plug, sealing the row perfectly and minimize the losses caused by poor sealing of the ends.

For producers who sell a portion of their crop, the Fusion720 Xtractor allows you to wrap inline to feed your own livestock, while saving on film. On the other hand, if your crops exceed the needs of your herd, the excess can be wrapped individually, allowing you to maximize the selling value of your bales by allowing you to sell them without deterioration of its quality.

Perfect also when the storage site is limited

and does not allow to wrap everything in one place, it is now possible to wrap bales individually with one machine.



With the Fusion720 Xtractor, you have the best of both worlds

Anderson, presents its latest innovation : the Fusion720 Xtractor, a single machine that can wrap everything!

- Versatility and speed
- Wrapping optimization
- Plastic economy



TECHNICAL SPECIFICATIONS

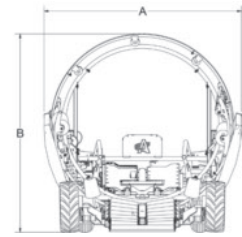
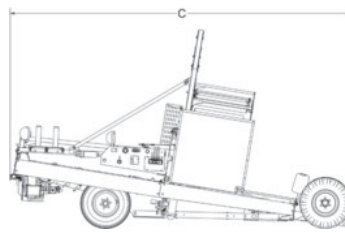

		NWS720	IFX720 XTRACTOR	HYBRID X XTRACTOR	EVOLUTION XTRACTOR	FUSION720 XTRACTOR
BALES	Round bale diameter**	Up to 6 ft (1.8 m)	Up to 6 ft (1.8 m)	Up to 6 ft (1.8 m)	Up to 6 ft (1.8 m)	Up to 6 ft (1.8 m) inline wrapping Up to 5 ft (1.5 m) individual wrapping
	Round bale length	Up to 5 ft (1.5 m)	Up to 5 ft (1.5 m)	Up to 5 ft (1.5 m)	Up to 5 ft (1.5 m)	Up to 5 ft (1.5 m)
	Square bale	N/A	N/A	3 ft x 3 ft (80 x 90 cm) or 4 ft x 3 ft (90 x 120 cm) Up to 6 ft (1.8 m)	3 ft x 3 ft (80 x 90 cm) or 4 ft x 3 ft (90 x 120 cm) Up to 6 ft (1.8 m) (single or double stacked)	N/A
	Wrapping speed*	Up to 180 bales/h	Up to 180 bales/h	Up to 180 bales/h	Up to 200 bales/h	Up to 140 bales/hr (inline wrapping) Up to 50 bales/hr (single bale wrapping)
SPECIFICATIONS	Aluminum film stretcher	2 x 30 in (750 mm) or 4 x 30 in (optional)	2 x 30 in (750 mm) or 4 x 30 in (optional)	4 x 30 in (750 mm)	4 x 30 in (750 mm)	2 x 30 in (750 mm)
	Engine	13 HP Honda (20 HP optional)	13 HP Honda (20 HP optional)	13 HP Honda (20 HP optional)	20 HP Honda	20 HP Honda
	Final bale push off	MANUALLY	XTRACTOR™ automatic system	XTRACTOR™ automatic system	XTRACTOR™ automatic system	XTRACTOR™ automatic system
	Bed shape	V-shaped for round bales	V-shaped for round bales	Flat or V-shaped for all type bales	Flat for square bales	Flat shaped
	Bale guides for alignment	Adjustable	Adjustable	Adjustable	Adjustable	Adjustable
	Bale guides rollers	2	2	2	2	4
	Leveling system	Hydraulic lifting axle	Hydraulic lifting axle	Hydraulic lifting axle	Hydraulic jack	Hydraulic lifting axle
	Road lights	Standard	Standard	Standard	Standard	Standard
	Hoop speed	Adj. flow control valve	Adj. flow control valve	Adj. flow control valve	Adj. flow control valve	Adj. flow control valve
	Traction Tires	29 x 12.5-15	29 x 12.5-15	29 x 12.5-15	31 x 15.5-15	29 x 12.5-15
	Rear tires	11L-15	11L-15	11L-15	12.5L-15	9.5L-15 highway
	Hydraulic tail gate	Standard	Standard	Standard	Standard	Standard
	Auto-locking wheels	Standard	Standard	Standard	Standard	Standard
	Adjustable hydraulic compaction system	Standard	Standard	Standard	Standard	Standard
Smart start	Standard	Standard	Standard	Standard	Standard	
DIMENSIONS	Overall width – A	9 ft 10 in (2.99 m)	9 ft 10 in (2.99 m)	9 ft 8 in (2.95 m)	12 ft 1 in (3.73 m)	9 ft 10 in (2.99 m)
	Overall width (in transport mode)	9 ft 1 in (2.77 m)	9 ft 1 in (2.77 m)	8 ft 5 in (2.56 m)	11 ft (3.35 m)	9 ft 1 in (2.77 m)
	Overall height – B	9 ft 9 in (2.98 m)	9 ft 9 in (2.98 m)	9 ft 4 in (2.87 m)	12 ft (3.67 m)	9 ft 10 in (3 m)
	Overall length	18 ft 6 in (5.64 m)	18 ft 6 in (5.64 m)	18 ft 9 in (5.74 m)	21 ft (6.43 m)	19 ft 5 in (5.91 m)
	Overall length (in transport mode)	17 in (5.18 m)	17 in (5.18 m)	16 ft 9 in (5.12 m)	17 ft 3 in (5.29 m)	17 ft (5.18 m)
	Overall weight	4739 lb (2150 kg)	4739 lb (2150 kg)	5511 lb (2500 kg)	6746 lb (3060 kg)	6315 lb (2864 kg)
	Weight on tow bar	1058 lb (480 kg)	1058 lb (480 kg)	903 lb (410 kg)	1477 lb (670 kg)	1205 lb (547 kg)

* Speed based on wrapping 4 ft bales.

** Based on perfectly shaped 6 ft bales

Specifications and dimensions are subject to change without notice.

NWS720

	BASIC	NATURAL BORN LEADER	FARM KING	CUSTOM OPERATOR	CUSTOM OPERATOR ELITE
Plastic film watch		•	•	•	•
Working lights		•	•	•	•
Remote start and stop		•	•	•	•
Large capacity fuel tank (25L)		•	•	•	•
Remote steering			•	•	•
Automatic pilot				•	•
Electronic bale counter	Optional	Optional	Optional	•	•
2 extra stretchers	Optional	Optional	Optional	Optional	•
Stretcher protective shield	Optional	Optional	Optional	Optional	•
Honda engine	Available in 13hp or 20 HP	Available in 13hp or 20 HP	Available in 13hp or 20 HP	Available in 13hp or 20 HP	Available in 13hp or 20 HP



IFX720 XTRACTOR

	BASIC	NATURAL BORN LEADER	FARM KING	CUSTOM OPERATOR	CUSTOM OPERATOR ELITE
Plastic film watch		•	•	•	•
Working lights		•	•	•	•
Remote start and stop		•	•	•	•
Large capacity fuel tank (25L)	•	•	•	•	•
Remote steering			•	•	•
Automatic pilot				•	•
Electronic bale counter	Optional	Optional	Optional	•	•
2 extra stretchers	Optional	Optional	Optional	Optional	•
Stretcher protective shield	Optional	Optional	Optional	Optional	•
Honda engine	Available in 13hp or 20 HP	Available in 13hp or 20 HP	Available in 13hp or 20 HP	Available in 13hp or 20 HP	Available in 13hp or 20 HP



HYBRID X XTRACTOR

	FARM KING	CUSTOM OPERATOR
Plastic film watch	•	•
Working lights	•	•
Remote start and stop	•	•
Large capacity fuel tank (25L)	•	•
Remote steering	•	•
Automatic pilot		•
Electronic bale counter	Optional	•
2 extra stretchers	•	•
Stretcher protective shield	Optional	•
Honda engine	Available in 13hp or 20 HP	Available in 13hp or 20 HP



EVOLUTION XTRACTOR

	EVOLUTION 1	EVOLUTION 2
Plastic film watch	•	•
Working lights	•	•
Remote start and stop	•	•
Large capacity fuel tank (25L)	•	•
Remote steering	•	•
Automatic pilot		•
Electronic bale counter		•
2 extra stretchers	•	•
Stretcher protective shield	Optional	•
Honda engine	Standard 20hp	Standard 20hp



FUSION720 XTRACTOR

	CUSTOM OPERATOR ELITE COMBO
Plastic film watch	•
Working lights	•
Remote start and stop	•
Large capacity fuel tank (25L)	•
Remote steering	•
Automatic pilot	•
Electronic bale counter	•
2 extra stretchers	N/A
Stretcher protective shield	•
Honda engine	Standard 20hp







ANDERSON

INDIVIDUAL WRAPPERS



POWERED by
HONDA™

NEW

ELLIPSE 660

THE ONLY WRAPPER OF IT'S KIND DESIGNED TO HANDLE BALES LENGTH UPTO 5 FT, AND DIAMETER UP TO 5'6" FT (PAGE 53)



OUR PRODUCTS

Our individual wrappers are compact and easy to use. With exceptional stability and a manually or automatically operated wrapping system, they provide perfectly airtight bales, ensuring their preservation and nutritional value. Anderson's high manufacturing standards give you peace of mind and ensure efficient use and long life.



Their advantages

- Table with belts allowing each type of bale to turn and to be wrapped evenly.
- The bale guide rollers keep each bale centered on the platform when wrapping on a slope.
- Multiple models available designed to wrap stationary or trailed, automatic or manual.
- Products designed for field wrapping with its loading arm.
- Choice of models manufactured with remote control for the management of the wrapping processes directly from your seat.



ANDERSON

FIELD THE BEST

WRAP WITH EASE AND EFFICIENCY



1



2

3

POWERED by
HONDA™

Before purchasing any equipment, carefully read the technical specifications section of the product in question. Some features and options may not be available for all models.

BUILT ACCORDING TO YOUR NEEDS

We are aware that every farmer wants to invest in a product that meets their specific requirements. Our range of individual wrappers has a multitude of features that will allow you to choose a product that suits your needs.



1) Remote controlled

Our models can be delivered fully automated and controlled remotely. No need to get out of the tractor to select or change the configuration: changes can be made with the joystick from the tractor cab. It is therefore possible to start the wrapping cycle, pause it and reactivate it at any time. It is also easy to start or stop the motor remotely, select the number of table rotations, the number of layers of plastic, choose the speed of rotation of the table, the number of bales wrapped per day and the number total wrapped bales.

2) Bale receiver

You can also add a single position or three positions bale receiver. When wrapping on sloping ground, the three-position bale catcher allows you to unload the bale to the right, left or back and let it roll slowly to the ground.

3) Front and rear stabilizer

The front and rear stabilizer tabs provide a stationary wrapping on all surface types (available on the 680HS and 800HS models).



The most equipped in the industry

- Manual wrapping process with hydraulic control levers.
- Automatic wrapping process with remote control.
- Honda 13 HP 18 amp engine offering greater freedom of operation.
- Bale guide rollers and seamless belts.
- High quality 30 in aluminum tensioners that increase by 40 % the wrapping speed thanks to the second tensioner.
- Mechanical or hydraulic cutting systems.



Plastic cutting system

3 point hitch (quick-attach option)

Bale guide rollers



RB200

Individual wrapper



Up to 5 ft 6 in (1,65 m) diameter
Up to 5 ft (1,5 m) length



Manual wrapping process



Wrapping speed
Up to 30 bales per hour



Plastic cut only



Hydraulic control levers



Mechanical plastic cut and hold system



Bale and revolution counter



RB500

Individual wrapper



Up to 5 ft 6 in (1,65 m) diameter
Up to 5 ft (1,5 m) length



Manual wrapping process



Wrapping speed
Up to 40 bales per hour



Mechanical plastic cut and hold system



Remote control



Mechanical plastic cut and hold system



Honda engine available



RB600 AND RB600E

Individual wrapper



Up to 5 ft 6 in (1,65 m) diameter
Up to 5 ft (1,5 m) length



Automatic wrapping process



Wrapping speed
Up to 40 bales per hour



Mechanical plastic cut and hold system



Coupe plastique mécanique
contrôlé by levers



Table with belts



2 positions bale receiver



RB580

Individual wrapper



Up to 6 ft (1,8 m) diameter
Up to 5 ft (1,5 m) length



Wrapping speed
Up to 40 bales per hour



Loading arm for in-field wrapping



Manual wrapping process



Hydraulic plastic cut and hold
system

POWERED by
HONDA™



2 positions bale receiver



Interface computer



Second tensionner available



590HS

Individual wrapper



Up to 6 ft (1,8 m) diameter
Up to 5 ft (1,5 m) length



Wrapping speed
Up to 75 bales per hour



Loading arm for in-field wrapping



Automatic wrapping process



Hydraulic plastic cut and hold system



Front and rear stabilizer



13 HP engine



3 positions bale receiver



680HS

Model shown : Custom operator combo



Up to 6 ft (1,8 m) diameter
Up to 5 ft (1,5 m) length



Automatic wrapping process



Wrapping speed
Up to 75 bales per hour



Hydraulic plastic cut and hold system



Double tensioners available

Hydraulic plastic cut and hold

13 HP engine



800HS

Model shown : Custom operator combo



Up to 6 ft (1,8 m) diameter
Up to 5 ft (1,5 m) length



Wrapping speed
Up to 75 bales per hour



3 ft x 3 ft (80 x 90 cm)
jusqu'à 6 ft (1,8 m) de longueur



Automatic wrapping process



Hydraulic plastic cut and hold system

POWERED by
HONDA™



The bale rotates on its circumferences only. Perfect bale stability .



Wrap and carry a bale at the same time. No more stopping!



Cycle time is less than a minute (loading, wrapping, unloading)



ELLIPSE 660

Individual wrapper



Up to 5 ft 6 in (1,65 m) diameter

Up to 5 ft (1,5 m) length



Wrapping speed

Up to 75 bales per hour



Loading arm for in-field wrapping



Automatic wrapping process



Hydraulic plastic cut and hold system

TECHNICAL SPECIFICATIONS

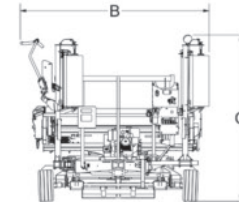
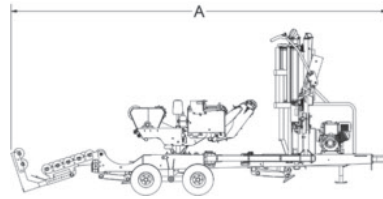

		RB200	RB500	RB580	590HS	RB600	RB600E	680HS	800HS	NEW ELLIPSE 660
BALES	Round bale diameter	Up to 5 ft 6 in (1.65 m)	Up to 5 ft 6 in (1.65 m)	Up to 6 ft (1.8 m)	Up to 6 ft (1.8 m)	Up to 5 ft 6 in (1.65 m)	Up to 5 ft 6 in (1.65 m)	Up to 6 ft (1.8 m)	Up to 6 ft (1.8 m)	Up to 5'6" (1.65m)
	Round bale length	Up to 5 ft (1.5 m)	Up to 5 ft (1.5 m)	Up to 5 ft (1.5 m)	Up to 5 ft (1.5 m)	Up to 5 ft (1.5 m)	Up to 5 ft (1.5 m)	Up to 5 ft (1.5 m)	Up to 5 ft (1.5 m)	Up to 5 ft (1.5 m)
	Square bale	N/A	N/A	N/A	N/A	N/A	N/A	N/A	3 ft x 3 ft (80 x 90 cm) Up to 6' (1.8 m)	N/A
	Wrapping speed	Up to 30 bales/h	Up to 40 bales/h	Up to 40 bales/h	Up to 75 bales/h	Up to 40 bales/h	Up to 40 bales/h	Up to 75 bales/h	Up to 75 bales/h	Up to 75 bales/h
	Wrapping process	Manual	Manual	Manual	Automatic	Automatic	Automatic	Automatic	Automatic	Automatic
	Mode	3 point hitch	Stationary	Pulled behind	Pulled behind	Stationary	Stationary	Stationary	Stationary	Stationary
SPECIFICATIONS	Aluminum film stretcher	1 x 30 in (750 mm)	1 x 30 in (750 mm)	1 x 30 in (750 mm)	1 x 30 in (750 mm) or 2 x 30 in (optional)	1 x 30 in (750 mm)	1 x 30 in (750 mm)	1 x 30 in (750 mm) or 2 x 30 in (optional)	1 x 30 in (750 mm) or 2 x 30 in (optional)	2 x 30"
	Engine	N/A	N/A	N/A	N/A	N/A	13 HP Honda (18 A)	13 HP Honda (18 A)	13 HP Honda (18 A)	N/A
	Bale dumper	N/A	N/A	2 positions	2 positions	N/A	N/A	1 position or 3 positions (optional)	Bale receiver platform	2 position bale dumper for bales of 4 and 5 feet
	Bale guides rollers	Standard	Standard	Standard	Standard	Standard	Standard	Standard	Standard	Standard
	Leveling system	N/A	N/A	N/A	N/A	N/A	N/A	Front and rear stabilizers	Front and rear stabilizers	N/A
	Road lights	N/A	N/A	For tractor	For tractor	N/A	N/A	For truck	For truck	For tractor
	Night Work lights	N/A	N/A	N/A	Standard	N/A	Standard	Standard	Standard	Standard
	Tires	N/A	18.5 x 8.5-8 (215/60-8)	26 x 12-12 (300/60-12)	26 x 12-12 (300/60-12)	18.5 x 8.5-8 (215/60-8)	18.5 x 8.5-8 (215/60-8)	26 x 12-12 (300/60-12)	20.5 x 8-10 (205/65-10)	15.0/55-17 14PRTL
	High flotation Tires	N/A	N/A	Standard	Standard	N/A	N/A	Standard	Standard	Standard
	Plastic cut & hold system	Plastic cut only	Mechanical	Mechanical	Hydraulic	Mechanical	Mechanical	Hydraulic	Hydraulic	Hydraulic
	Self-loading arm	N/A	N/A	Standard	Standard	N/A	N/A	N/A	N/A	Standard
	Electronic bale counter	Standard	Standard	Standard	Standard	Standard	Standard	Standard	Standard	Standard
	Tractor Minimum Hydraulic Flow	8 gal/min (30L/min)	8 gal/min (30L/min)	8 gal/min (30L/min)	8 gal/min (30L/min)	8 gal/min (30L/min)	Not required	Not required	Not required	15 gpm (57 liters/min)
Tractor Minimum Hydraulic Pressure	2200 psi (152 bar)	2200 psi (152 bar)	2200 psi (152 bar)	2200 psi (152 bar)	2200 psi (152 bar)	Not required	Not required	Not required	2500 psi (172 bar)	
Hydraulic connections	2 x 1/2" male quick couplers	2 x 1/2" male quick couplers	4 x 1/2" male quick couplers	4 x 1/2" male quick couplers 1 x 3/4" female quick coupling (Free return)	2 x 1/2" male quick couplers	N/A	N/A	N/A	"Option 1: Load sensing and pump output + 1 hydraulic output + free return Option 2: 2 hydraulic outputs + free return"	
DIMENSIONS	Overall length - A	100 7/8 in (2.54 m)	10 ft 10 in (3.3 m)	15 ft 7 in (4.77 m)	15 ft 7 in (4.77 m)	10 ft 10 in (3.3 m)	10 ft 10 in (3.3 m)	15 ft 7 in (4.77 m)	18 ft 2 in (5.56 m)	23 ft 1 in (7.04 m)
	Overall width - B	62 1/4 in (1.53 m)	6 ft 9 in (2.1 m)	8 ft 5 in (2.56 m)	8 ft 5 in (2.56 m)	6 ft 9 in (2.1 m)	6 ft 9 in (2.1 m)	7 ft 4 in (2.26 m)	7 ft 6 in (2.34 m)	9 ft 10 in (2.97 m)
	Overall height - C	73 in (1.85 m)	6 ft 8 in (2.1 m)	9 ft 8 in (2.98 m)	9 ft 8 in (2.98 m)	6 ft 8 in (2.1 m)	6 ft 8 in (2.1 m)	8 ft 5 in (2.60 m)	8 ft 4 in (2.57 m)	10 ft 7 in (3.22 m)
	Overall weight	1350 lb (612 kg)	1653 lb (750 kg)	3703 lb (1680 kg)	3703 lb (1680 kg)	1763 lb (800 kg)	1763 lb (800 kg)	3207 lb (1455 kg)	4519 lb (2050 kg)	5780 lbs (2621 kg)

Specifications and dimensions are subject to change without notice.

POWERED by
HONDA

RB580 & 590HS

	RB580	590HS FARM KING COMBO	590HS CUSTOM OPERATOR COMBO
Wrapping process	Manual	Automatic	Automatic
Plastic cut & hold system	Mechanical	Hydraulic	Hydraulic
Bale dumper	2 positions	2 positions	2 positions
Aluminum film stretcher	1	1	2



680HS

	NATURAL BORN LEADER COMBO	FARM KING COMBO	CUSTOM OPERATOR COMBO
Automated remote controlled	•	•	•
Hydraulic plastic cut & hold system*	•	•	•
Honda engine 13 HP**	•	•	•
Front and rear stabilizers	•	•	•
Bale dumper	Roll-off	3 positions	3 positions
Aluminum film stretcher	1	1	2



800HS

	FARM KING COMBO	CUSTOM OPERATOR COMBO
Automated remote controlled	•	•
Hydraulic plastic cut & hold system*	•	•
Honda engine 13 HP**	•	•
Front and rear stabilizers	•	•
Bale dumper	Hydraulic	Hydraulic
Aluminum film stretcher	1	2
Road lights (for truck)	•	•
Tandem axle	•	•



* Hold the film in place and cuts it automatically after each bale.
 ** Offers high horsepower, exceptional adaptability great fuel efficiency.

ELLIPSE660

NEW

STANDARD

	STANDARD
Automated remote controlled	•
Hydraulic plastic cut & hold system	•
Loading arm for picking up bale in field	•
Front and rear stabilizers	•
Road lights (for truck)	•
Bale dumper	•
Aluminum film stretcher	2





FENDT

ANDERSON



ANDERSON

ACCESSORIES



HANDLE A WIDE VARIETY OF BALES

Whether the bales are wrapped in a plastic film, wrapped in a net or in conventional twine, know that the Anderson bale grabbers will be a productive accessory that will last for years. With our bale grabbers, you can stack the bales vertically or on their sides. The floating free arm design allows you to stack or load without damaging nearby bales. This design also provides the operator with loading flexibility allowing the bale grabber arms to slide easily between the bales.

MODEL 4000



For round bales up to 60 in (1.5 m) diameter.



Opening the arms
Minimum: 33 1/2 in (86 cm)
Maximum: 68 in (173 cm)



2 cylinders



Frame 66 3/4 in (167 cm)
in length



Weight of 420 lb (190,5 kg)



MODEL 5000



Up to 63 in (1.57 m)
of diameter



Opening the arms
Minimum: 33 1/2 in (86 cm)
Maximum: 84 in (213 cm)



1 cylinder

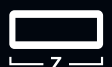

Frame 65 in (165 cm)
in length



Weight of 460 lb (208,5 kg)

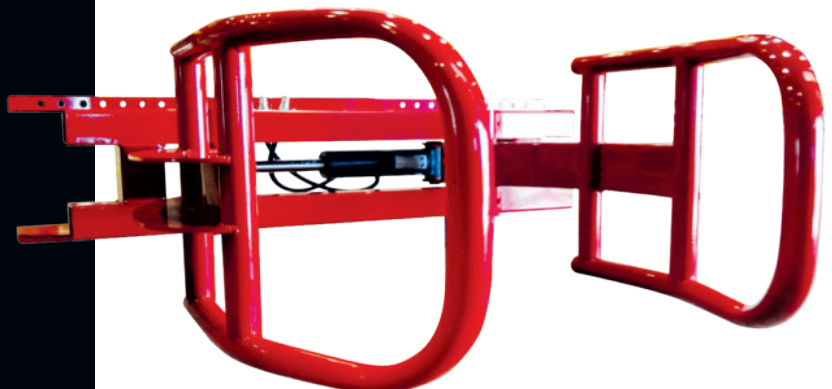

MODEL 6000



Up to 7 ft (2,1 m) long



Diameter of bale
Minimum: 54 in (137 cm)
Maximum: 84 in (213 cm)



Opening the arms
Minimum: 19 in (48 cm)
Maximum: 90 in (229 cm)



2 cylinders



Frame 66 3/4 in (167 cm)
in length



Weight of 470 lb (213,2 kg)



BALE SPEARS

Simple tools for handling round or square bales



Bale spear (1)
for round bales



Bale spear (2)
for round and square bales



Protector shield for spears



QUICK ATTACH



Available on demand





ANDERSON

**ROUND BALE
MOVERS**



DO MORE WITH ONE TRACTOR AND ONE OPERATOR!

Easy pickup

The shape of the loading fork allows the bales to be picked up easily no matter how they are placed in the field. The action of the fork allows the bale to rotate a quarter of a turn, which places it perfectly for its pickup.



The perfect unloading angle

The less pronounced unloading angle of Anderson self-loading trailers allows them to unload on all possible terrain angles without the risk of rolling or tumbling bales. The pressure movement of the hydraulic pusher ensures bales on the ground closer to each other and thus saves space. A safe and efficient way every time!



Adjustable according to bale size

The arm and the platform are adjustable to adapt to your type of bales. The bale guides move on rollers, allowing for an easy and fast adjustment practically without efforts.



Height matters!

Our trailers have high ground clearance to provide as much versatility as possible for transport and pickup in rough terrain.



EFFICIENCY AND SPEED

These heavy-duty self-loading trailers are designed to pick up and haul wet or dry hay, making you faster and more efficient in the field. The hydraulic bale receiving platform allows the bales to be positioned perfectly on the trailer and to maximize the amount transported. With its manufacturing profile, the operator keeps optimal visibility of its load, even on rough terrain. Model available with or without brakes.



We build our trailers with you in mind

- Model available with or without brakes.
- Steel platform supporting wet bales
- Adapts to bale diameters from 4' to 6'
- Integrated pickup technologies
- Hydraulic bale pusher.
- Hydraulic jack
- Optional bale separator that allows the rows of bales to space out the rows when unloading

ANDERSON

FIELD THE BEST



Before purchasing any equipment, carefully read the technical specifications section of the product in question. Some options and features may be incompatible with certain models as well as not available in some countries. For more information, please contact your authorized Anderson dealer.

UNPARALLELED POWER AND MANEUVERABILITY

Our self-loading trailers are designed to pick up up to 20 round bales of wet or dry hay in a simpler and faster way. The loading aid (especially important when picking up) allows easy handling even at high speeds and an improved loading sensation.

1) High flotation tires

High flotation tires help reduce compaction while providing safe transport for wet or dry bales.

2) Efficiency and speed

These heavy-duty self-loading trailers are designed to pick up and transport wet or dry hay, making you more efficient at field. The hydraulic bale receiving platform allows them to be positioned perfectly on the trailer and to maximize the amount transported. With its manufacturing profile, the operator keeps optimal visibility of its load, even on rough terrain.

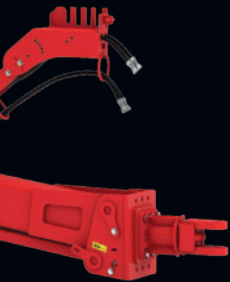

3) The loading arm

The round tubular shaped loading arm is designed to quickly pick up round silage and hay bales while protecting the net from tears, string or twine breaks.

4) Easy loading

The technology that supports the loading arm allows you to follow the path of the baler for fast loading without stopping. It saves loading time in the field and even allows you to pick up an extra load of bales. The arm and sides of the platforms are adjustable to fit your type of bales.

5) Bale separator (optional)

Allows spacing of rows of balls at unloading.

6) Optimal performances

Precise steering and a full load indicator on the trailer allow you to continue working effectively for many hours. The tandem axle provides a stable and optimal performance to the machine.

Effortless loading

The hydraulic unloading system is made by tilting the platform so as to accurately and gently deposit the bales on the ground. The bales are left on the ground linearly and perfectly positioned to facilitate their subsequent wrapping or handling.





Effortless gravity unloading at 40 degree angle



Adjustable loading arm



Tandem axle and high flotation tires



TRB1000

Self-loading trailer for round bales



Up to 5 ft 6 in (1.65 m) in diameter)



3 double hydraulic outlets required



Transport capacity of 8 to 10 bales per load



Hydraulic tractor control



HP PTO Requirement 100 HP



Effortless unloading by continuous hydraulic thrust



Hydraulic jack

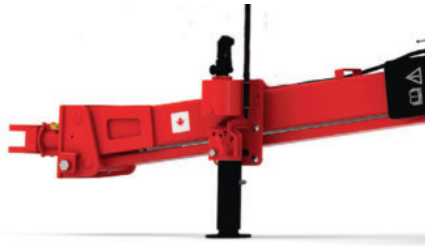

Adjustable bale guide for 6' bales



RBM1000

Self-loading trailer for round bales



Up to 6 ft (1.8 m) in diameter



3 double hydraulic outlets required



Transport capacity of 8 to 10 bales per load



Hydraulic tractor control



HP PTO Requirement 115 HP



Effortless unloading by continuous hydraulic thrust



Adjustable tubular loading arm



Tandem axle and high flotation tires



RBM1400

Self-loading trailer for round bales



Up to 6 ft (1.8 m) in diameter



Transport capacity of 12 to 14 bales per load



HP PTO Requirement 115 HP



3 double hydraulic outlets required



Hydraulic tractor control



Telescopic loading arm



Effortless unloading



Fingertip joystick available



RBM2000

Self-loading trailer for round bales



Up to 6 ft (1.8 m) in diameter



4 double hydraulic outlets required (option: selector valve to reduce the number of outputs required)



Transport capacity of 17 to 20 bales per load



Controlled by the tractor's hydraulics (optional fingertip joystick)



HP PTO Requirement 130 HP

TECHNICAL SPECIFICATIONS

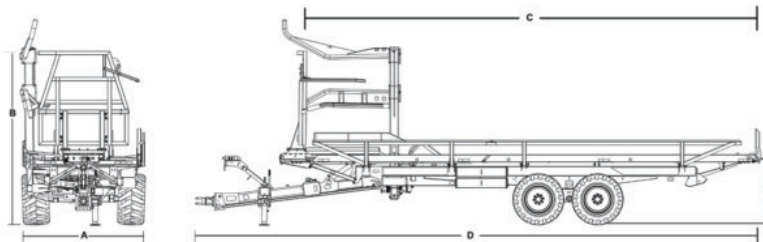

		TRB1000	RBM1000	RBM1400	RBM2000
BALES	Round bale diameter	Up to 5 ft 6 in (1.65 m)	Up to 6 ft (1.8 m)	Up to 6 ft (1.8 m)	Up to 6 ft (1.8 m)
	Bale type	Baleage/dry hay/straw	Baleage/dry hay/straw	Baleage/dry hay/straw	Baleage/dry hay/straw
SPECIFICATIONS	Tandem axle	Standard	Standard	Standard	Standard
	Tandem axle with brakes	Optional	Optional	Optional	Optional
	Self-Steering axle with brakes	N/A	Optional	Optional	Optional
	Safety chain	Standard	Standard	Standard	Standard
	Self-loading arm design	Tubular round	Tubular round	Tubular round	Tubular round
	Able to load a second row of bales	N/A	N/A	N/A	Telescopic
	Tires	400/60-22.5	560/45-R22.5	560/45-R22.5	560/45-R22.5
	Backup camera	n/a	Optional	Optional	Optional
	Tractor minimum hydraulic flow	10 gal/min (38 L/min)	10 gal/min (38 L/min)	10 gal/min (38 L/min)	10 gal/min (38 L/min)
	Tractor minimum hydraulic flow	2500 psi (172 bar)	50 psi (5 bar)	2500 psi (172 bar)	2500 psi (172 bar)
	HP requirements	100 HP	115 HP	115 HP	130 HP
	Double hydraulic connections required	3	3	3	4 Or 2 if fingertip joystick option
PTO Speed/ PTO shaft	N/A	N/A	N/A	N/A	
Controls	Tractor's hydraulic circuit	Tractor's hydraulic circuit	Tractor's hydraulic circuit	Tractor's hydraulics (option : fingertip joystick)	
DIMENSIONS	Width - A	8 ft 5 in (2.6 m)	8 ft 4 po (2.55 m)	8 ft 4 in (2.55 m)	8 ft 4 in (2.55 m)
	Overall width (including loading arm)	9 ft 1 in (2.8 m)	8 ft 4 po (2.55 m)	8 ft 4 in (2.55 m)	8 ft 4 in (2.55 m)
	Height - B	7 ft 5 in (2.3 m)	7 ft 10 po (2.39 m)	7 ft 10 in (2.39 m)	11 ft 10 in (3.61 m)
	Overall height (including loading arm)	11 ft 1 in (3.38 m)	11 ft 11 po (3.64 m)	11 ft 11 in (3.64 m)	12 ft (3.66 m)
	Bed height - E	3 ft 9 in (1.1 m)	4 ft 9 po (1.44 m)	4 ft 9 in (1.44 m)	4 ft 9 in (1.44 m)
	Overall length - D	21 ft (6.4 m)	30 ft 5 po (9.27 m)	38 ft 5 in (11.76 m)	38 ft 5 in (11.76 m)
	Overall weight	3200 kg (7 054 lb)	5000 kg (11 025 lb)	5 000 kg (12 790 lb)	6100 kg (13 450 lb)
	Empty Weight on tow bar***	680 kg (1 499 lb)	825 kg (1 820 lb)	1 295 kg (2 855 lb)	1 455 kg (3 205 lb)

* Option available : selector valve to reduce the number of required outputs

** Option available : control by fingertip joystick

*** On standard tandem axle model

Specifications and dimensions are subject to change without notice.

TIRES





DIMENSIONS	RIMS	WIDTH	DIAMETER	MAX LOAD PER WHEELS AT 40KM/HR	INFLATION PRESSURE	PLYS
400/60-22.5	22.5 x 11.75	16 in (400 mm)	42.1 in (1070 mm)	4000 kg (8820 lb)	51 psi (3.5 bar)	16
560/45-R22.5	22.5 x 16.00	21.4 po (543 mm)	42.4 po (1076 mm)	4825 kg (10635 lb)	58 psi (4 bar)	5B (steel belt)

BALE LOADING CAPACITY AND SPEED

		TRB1000 / RBM1000	RBM1400	RBM2000
CAPACITY	Round bale 4 ft x 4 ft diameter (1,2 m x 1,2 m)	10	14	20
	Round bale 4 ft x 5 ft diameter (1,2 m x 1,5 m)	10	14	20
	Round bale 4 ft x 6 ft diameter (1,2 m x 1,8 m)	0/10	14	20
	Round bale 5 ft x 5 ft diameter (1,5 m x 1,5 m)	8	12	17
	Round bale 5 ft x 6 ft diameter (1,5 m x 1,8 m)	0/8	12	17
	Loading arm lifting capacity	1135 kg (2500 lb)	1135 kg (2500 lb)/	1135 kg (2500 lb)/
Total weight including load		13 500 kg (29 800 lb) / 19 000 kg (42 000 lb)	19 000 kg (42 000 lb)	19 000 kg (42 000 lb)

* Standard model without brakes

BALES TRANSPORTED / HOUR AND CYCLE TIME

		STANDARD	TRB1000 / RBM1000	RBM1400	RBM2000
					
		1 tractor - 1 operator 2 wagons of 10 round bales	1 tractor - 1 operator 1 trailer of 10 round bales	1 tractor - 1 operator 1 trailer of 14 round bales	1 tractor - 1 operator 1 trailer of 20 round bales
DISTANCE FROM FIELD TO STORAGE SITE	1 mile (1,6 km)	39 bales/hour	50 bales/hour	62 bales/hour	75 bales/hour
	2 miles (3,2 km)	32 bales/hour	31 bales/hour	40 bales/hour	51 bales/hour
	3 miles (4,8 km)	26 bales/hour	23 bales/hour	30 bales/hour	40 bales/hour
	4 miles (6,4 km)	23 bales/hour	18 bales/hour	24 bales/hour	32 bales/hour
	5 miles (8 km)	20 bales/hour	15 bales/hour	20 bales/hour	27 bales/hour
CYCLE TIME	Go to the fields	3 min.	3 min.	3 min.	3 min.
	Loading	20 min.	4 min.	6 min.	8 min.
	Return to the site	4,3 min.	4,3 min.	4,3 min.	4,3 min.
	Unloading	3,3 min.	0,5 min.	0,5 min.	0,5 min.
	Total cycle time	30,6 min./mile	11,8 min./mile	13,8 min./mile	15,8 min./mile

Standard methods compared to Anderson bale movers**

* Calculation method: Empty trailer transport speed: 20 mph (32 km / h) - Full trailer transport speed: 14 mph (22 km / h)



** The equipment speed data is only used for comparison purposes between models.





ANDERSON

**ROUND BALE
MOVERS FOR**

**WRAPPED
BALES**





REAL TIME BALE COLLECTING!

The Anderson Group is proud to introduce the world's first self-loading bale carrier capable of handling efficiently wrapped silage bales.

The RBMPRO series can move nearly twice as many bales as any traditional platform system. It reduces the time spent in the field, the labor, as well as the fuel consumption. This allows more time for the farmer or the contractor to spend it where it counts!

Finally, the superior productivity of the RBMPRO series helps to free the field as quickly as the baler passes through it, all without risks of breaking the plastic.



Essential features

and advantages

- Greater speed than traditional methods
- Fully automated pickup system
- Promotes rapid regrowth of the crop by quickly removing bales from the field.
- Promotes quality fermentation of wrapped bales
- Faster loading system : 14 bales in 6 minutes and 20 bales 8,5 minutes

Completely automated

Number of bales and client statistics

- Loading mode
- Unloading mode
- Manual mode
- Parameters



- Travel mode
- Bale position



WHAT SETS US APART

Only one operator

The RBMPRO is a trailer requiring the operation of a single person. A tractor operator can load, transport and unload without using a second piece of equipment. Therefore, it takes less manpower and less time to achieve the same results as with other equipment. Fewer hours spent here give farmers the opportunity to use their time where it counts. The high productivity of the RBMPRO series can easily follow up to 2 combined balers or individual wrappers. Field compaction is reduced by taking the same path as other machines used.

Increased feed quality

Handling the bales during the fermentation process causes the oxygen to escape through the plastic layers and decreases the fermentation efficiency. With the RBMPRO series the bales are collected immediately after the wrapping process which makes the fermentation process optimal thus generating a higher nutritional value.

Productive logistics

It is well known that moving wrapped silage bales out of a field takes time. The RBMPRO is the solution! With a single operator you will now be able to move nearly twice as many bales as any traditional platform system.

Less soil compaction

Avoid back and forth in your field by reducing the machinery needed to harvest your silage. The RBMPRO will be able to follow the same track as the wrapper or the baler no matter field conditions and thus reduce soil compaction.

Immediate regrowth

The pick up of the silage bales will promote a quick and healthy recovery of your crops. No more wrapped bales will prevent the growth of the underlying grass.

Plastic care system

Thanks to the unique design of our loading arm you will reduce the risk of perforation of the plastic caused by the wrong loading device.

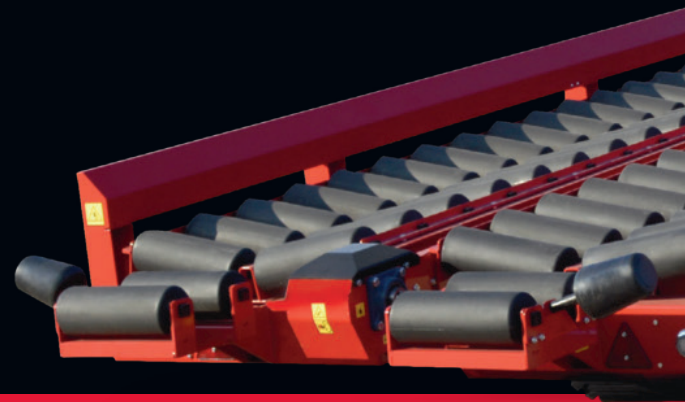

Designed to meet your needs

- Optimal fermentation of silage bales with high nutritional value
- Operation by one person
- Less equipment involved
- Less time spent carrying bales
- Reduced soil compaction compared to other traditional methods.



Before purchasing any equipment, carefully read the technical specifications section of the product in question. Some options and features may be incompatible with certain models as well as not available in some countries. For more information, please contact your authorized Anderson dealer.

The RBMPRO is currently under patent pending

Vertical or horizontal unloading

It is possible to unload the wrapped bales either on their side or on their flat end, which eliminates the risk of perforation of the plastic and that by simply by placing them gently on the ground.



RBMPRO

Built from a strong history of automatic loading trailer design that can handle all bale sizes and conditions, the Anderson Group has combined the best available resources to provide this unique equipment that will make it easier for farmers and agricultural contractors.

1) Loading arm

The unique arm reduces plastic breakage and treats each bale gently to prevent punctures.

2) Telescopic loading arm

The RBMPRO also has a "telescopic loading arm" that allows you to load a third row of bales. This feature is useful for silage bales, dry hay or straw and allows up to 20 bales per trip on certain models.

3) Adjustable rolling bed platform

A roller platform allows the bales to be gently pushed back without stretching or damaging the plastic. The platform can be hydraulically adjusted in width to increase the distance between each row to match the diameter of the round bale.

4) Rear hydraulic stopper roller

The purpose of this system is to hold the bales on the platform during the loading and transport of bales from the field to the storage site. The system is retracted just before tilting the platform during unloading to allow the bales to slide gently backwards and to the ground.

5) Load security system

This system makes it possible, with additional height, to hold the bale load securely in place without having to attach it with straps for transport. (be sure to check and meet the road regulations of your country)

6) Rotating grabber and loading arm

The RBMPRO has been designed to pick up individually wrapped bales positioned vertically or on their flat end. With simple activation on the touch screen monitor, the operator can rotate the clamp to quickly and effortlessly pick up any size bales in any position. Most manufacturers of balers or combination baler/wrapper offer a "turning device" that propels the bale upwards. This position is also the safest when unloading because several layers of plastic are applied on both flat ends of the bale, thus ensuring no perforation when it is deposited on the ground. However, although they may place the bale upright on the field, these "turning devices" operate 95% of the time, but 5% of the time, the bale may fall horizontally due to the inclination of the ground or maneuvers of the operator. The RBMPRO will do the job either way!

7) In motion loading technology

The RBMPRO also incorporates the "In Motion Loading System" technology. Designed by Anderson the system prevents the driver from stopping the tractor when he grabs the bale during the initial loading phase. The loading arm will move backwards when the bale comes into contact with the loading arm, preventing it from dragging on the ground. This allows the grapple to pick up the bale and lift it off the ground while the tractor operator moves forward. Between each load, the tractor operator can easily accelerate to the next bale. The "In Motion Loading System" improves productivity by eliminating the down time and requires less concentration and effort on the part of the tractor operator.

8) Fully automated loading system

The Danfoss Plus 1 controller and Danfoss DP720 touch screen monitor eliminates human interaction during the loading phase. In fact, the loading arm is equipped with a bale detector that will launch the loading sequence. The tractor operator must simply go to the next bale and let the RBMPRO do the work.





Load 2 or 3 rows



Fully automated system



Bale guide adjustable hydraulically



RBMPRO 1400™ (FULLY AUTOMATED)

Self-loading bale mover for wrapped round bales



Up to 5 ft (1.5 m) in diameter



3 double hydraulic outlets + LS ready



Transport capacity of 8 to 14 bales per load
(Silage: 2 rows side by side
dry hay and straw: 3 pyramidal rows)



HP PTO Requirement 130 HP



In-Motion loading arm technology



Fully automated system



Adjustable rolling bed platform



RBM PRO 2000™ (FULLY AUTOMATED)

Self-loading bale mover for wrapped round bales



Up to 5 ft (1.5 m) in diameter



3 double hydraulic outlets +
LS ready



Transport capacity of 12 to 20 bales per load
(Silage: 2 rows side by side
dry hay and straw: 3 pyramidal rows)



HP PTO Requirement 130 HP

TECHNICAL SPECIFICATIONS

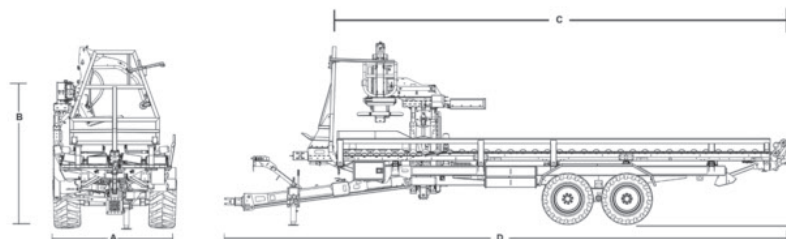

		RBMPRO 1400	RBMPRO 2000
BALES	Round bale diameter	Up to 5 ft (1.5 m)	Up to 5 ft (1.5 m)
	Bale type	Wrapped Baleage/dry hay/straw	Wrapped Baleage/dry hay/straw
SPECIFICATIONS	Tandem axle	Standard	Standard
	Tandem axle with brakes	Optional	Optional
	Self-Steering axle with brakes	Optional	Optional
	Safety chain	Standard - clevis hitch	Standard - clevis hitch
	Self-loading arm design	Hydraulic clamp	Hydraulic clamp
	Able to load a second row of bales	Telescopic arm	Telescopic arm
	Tires	560/45-R22,55	560/45-R22.5
	Backup camera		
	Tractor Minimum Hydraulic Flow	15 gal/min (60 L/min)	15 gal/min (60 L/min)
	Tractor Minimum Hydraulic Pressure	2800 psi (190 bar)	2800 psi (190 bar)
	HP requirements	130 HP	130 HP
	Double hydraulic connections required	3+LS	3+LS
	PTO Speed / PTO shaft	N/A	N/A
Controls	Touchscreen display	Touchscreen display	
DIMENSIONS	Width - A	8 ft 4 in (2.55 m)	8 ft 4 in (2.55 m)
	Overall width (including loading arm)	8 ft 4 in (2.55 m)	8 ft 4 in (2.55 m)
	Height	12 ft 2 in (3.71m)	12 ft 2 in (3.71m)
	Overall height (including loading arm) - B	12 ft 6 in (3.81m)	12 ft 6 in (3.81m)
	Overall length - D	30 ft 5 in (9,27 m)	38 pi 5 in (11.76 m)
	Bed height - E	5 ft (1.55 m)	5 pi (1.55 m)
	Overall weight *	13 225 lb (6 000 kg)	14 990 lb (6 800 kg)
	Empty Weight on tow bar	2 300 lb (1000 kg)	3 415 lb (1550 kg)

Specifications and dimensions are subject to change without notice.

*Weight for standard tandem axle without brake

TIRES

DIMENSIONS	JANTES	LARGEUR	DIAMÈTRE	CHARGE MAXIMUM PAR ROUE À 40 KM/H	PRESSION DE GONFLAGE	PLIS
400/60-22,5	22.5 x 11.75	16 in (400 mm)	42,1 in (1070 mm)	4000 kg (8820 lb)	51 psi (3.5 bar)	16
560/45-R22,5	22.5 x 16.00	21,4 po (543 mm)	42,4 po (1076 mm)	4825 kg (10635 lb)	58 psi (4 bar)	5B (steel belt)

BALE LOADING CAPACITY AND SPEED

		RBMPRO 1400	RBMPRO 2000
CAPACITY	Round bale 4 ft x 4 ft diameter (1,2 m x 1,2 m) ***	In 2 rows = 10 In 3 rows = 13 or 14	In 2 rows = 14 In 3 rows = 19 or 20
	Round bale 4 ft x 5 ft diameter (1,2 m x 1,5 m) ***	In 2 rows = 10 In 3 rows = 13 or 14	In 2 rows = 14 In 3 rows = 19 or 20
	Round bale 4 ft x 6 ft diameter (1,2 m x 1,8 m)	N/A	N/A
	Round bale 5 ft x 5 ft diameter (1,5 m x 1,5 m) ***	In 2 rows = 8 In 3 rows = 10 or 11	In 2 rows = 12 In 3 rows = 16 or 17
	Round bale 5 ft x 6 ft diameter (1,5 m x 1,8 m)	N/A	N/A
	Loading arm lifting capacity	1135 kg (2500 lb)	1135 kg (2500 lb)
	Total weight including load	19 000 kg (42 000 lb)	19 000 kg (42 000 lb)
BALES TRANSPORTED PER HOUR	On a distance of 0,62 mile (1 km)	64	75
	On a distance of 1,24 mile (2 km)	45	55
	On a distance of 1,86 mile (3 km)	35	43
	On a distance of 2,48 miles (4 km)	29	36
	On a distance of 3,10 miles (5 km)	25	30

- ** Equipment runtime data is for comparison between models only.
- ***Check local regulations before driving on public roads to respect the maximum height and width allowed.





★ ANDERSON
WRAPTOR

ANDERSON

WRAPTOR

**ALL-IN-ONE
SYSTEM**

**POWERED by
HONDA™**





EFFICIENTLY TRANSPORT AND WRAP WITH THE WRAPTOR!

The WRAPTOR™ is the ultimate system for loading, transporting and wrapping. It consists of a combination of a self-loading trailer and an inline wrapper adapted to speed up your operations.

Designed to pick up dry or wet hay and wrap non-stop, it delivers the fastest performance on the market without wasting time. With the fastest bale wrapping system on the market, transport and wrap 14 bales in less than four minutes with one operator and one tractor.



This system offers the perfect solution!

- When labor is hard to find
- When the weather does not cooperate and you need to do things quickly

One unique combination!

The WRAPTOR™ is the ultimate system for loading, transporting and wrapping. Designed for collecting wet or dry hay, it offers the fastest performance on the market.

THE WRAPTOR™

FASTER WITH LESS LABOR



POWERED by
HONDA™

IT IS BOTH WRAPPER AND BALE MOVER

The WRAPTOR™ includes two unique machines that are not designed to be sold separately. The self-loading trailer wraps 14 4 ft x 4 ft bales at a time. Its loading arm allows it to follow the baler and collect them directly in their position by rotating them gently before picking them up and loading them. When the load is finished, the trailer is then attached to the wrapper, without additional equipment and without having to leave the tractor. The pusher then allows the trailer to push the bales directly into the wrapper by an uninterrupted process. The wrapper attaches directly to the trailer, so transport from one site to another is facilitated.



The WRAPTOR™,
a simple and fully automatic WRAPPING system

- The inclination of the draw bar facilitates attachment of the trailer to the wrapper.
- The hydraulic pusher system pushes and unloads the bales quickly.
- The four tensioners make it possible to replace rolls less often and coat more quickly.
- The trailer with the tubular loading arm provides net protection.
- The bale guide rolls keep each bale centered on the platform when wrapping on a slope.
- The hydraulic jack leveling system prevents the first bales from tumbling and holds them together to begin wrapping your bales more easily.



WRAPTOR™

All-in-one system



Up to 5 ft (1.5 m) length



Silage and hay bale



HP PTO required 100 HP
13 HP Honda engine



Hydraulic compaction system for bales



Adjustable hoop speed with flow control valve



Remote control of the wrapping

TECHNICAL SPECIFICATIONS

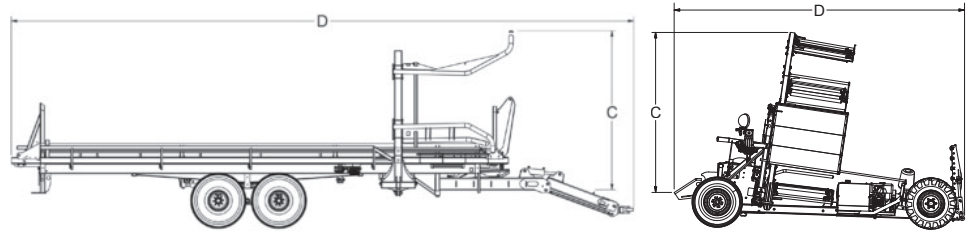

WRAPTOR™		TRAILER	INLINE WRAPPER
BALES	Round bale diameter	Up to 5 ft (1,5 m)	Up to 5 ft (1,5 m)
	Square bale	N/A	N/A
	Bale type	Baleage and dry hay	Baleage and dry hay
DIMENSIONS	Width	8 ft 4 in (2,5 m)	9 ft 6 in (2,8 m)
	Overall width (including loading arm) - A	9 ft 8 in (3 m)	In transport mode 8 ft 5 in (2,5 m)
	Height - C	8 ft 8 in (2,7 m)	9 ft 7 in (2,9 m)
	Overall height (including loading arm) - B	12 ft (3,6 m)	9 ft 7 in (2,9 m)
	Bed height	4 ft 6 in (1,4 m)	N/A
	Overall length - D	41 ft 3 in (12,6 m)	14 ft 6 in (4,4 m)
	Overall weight	10800 lb (4870 kg)	13571 lb (1620 kg)
	Weight on tow bar	875 kg (1925 lb)	550 kg (1215 lb)

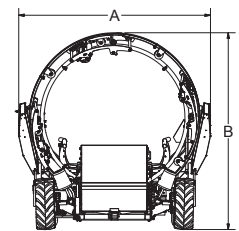
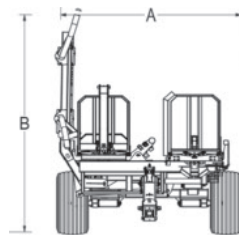

SPECIFICATIONS		TRAILER
Loading capacity on axle (including bale carrier weight)		40000 lb (18143 kg)
Hydraulic unloading		Standard
Pusher travel stroke		5' 1" à 7" (1,5 à 2,1 m)
Hydraulic push ramp system		Standard
Full charge indicator		Standard
Double plate hitch		Standard
Road lights		Standard
Steerable Tandem axle		Standard
Self-loading arm design		Tubular round
Tilting tow bar for easy hook-up to wrapper		Standard
Adjustable lateral ramp according to bale dimension		Standard
Camera		Standard
Tires		550/45-22.5
Minimum Hydraulic Flow		10 Gal/min (37 litres/min)
Minimum Hydraulic Pressure		2200 psi (152 bar)
Minimum HP requirements		100 HP
Remote outlets required		2

SPECIFICATIONS		INLINE WRAPPER
Aluminum film stretcher		4 x 30 in (750 mm)
Engine		With the trailer pusher
Final bale push off		V-shaped for round bales
Bed shape		Standard
Bale guides for alignment		Adjustable
Bale guides rollers		2
Leveling system		Hydraulic jack
Road lights for tractor		Standard
Hoop speed		N/A
Traction Tires		Adj. flow control valve
Rear tires		29 x 12,5-15
Hydraulic tail gate		11L-15
Auto-locking wheels		Standard
Adjustable hydraulic compaction system		Standard
Plastic film watch		N/A
Working light		Standard
Remote control wrapping		N/A
Large fuel Tank		N/A
Automatic pilot sensors		13 HP Honda
20 HP Honda engine		N/A







ANDERSON

**SQUARE
BALE
MOVERS**





ANDERSON TOUGH!

Anderson square bale self-loading trailers are designed and built to help you go further and faster with the loading capacity you need. They offer optimal payload and robust towing as well as state-of-the-art technology.



What's in it for you

- Fully automated loading system
- Digital pickup aid for easy handling
- Robust design to cope with the most extreme conditions
- Increased productivity
- Time saving
- A reduced need for labor



THE STACKPRO SERIES, THE MOST PRODUCTIVE YET

It has been proven that the Stackpro series is more productive than any other brand on the market compared to an equivalent model size.

The two trailers in the Stackpro series make it easy to collect and stack square bales. They are intended for farmers who want to maximize the time spent on logistics throughout the year.

The only difference between the two models is their size. Their robustness allows them to endure the most extreme conditions and can handle almost all types and sizes of square bales. Their high speed also ensures smooth transitions, easy transport and stacking of bales. Their increased productivity allows an economy of investment, a saving of time and manpower.

Without any compromises

The Stackpro, 20% heavier than their competitors, are designed for intense work days and can cope with the most difficult conditions. This ensures uninterrupted work sites to increase your productivity.

What sets us apart

- Robust chassis that benefits all operations
- High efficiency automatic loading
- Automated loading cycle
- 90° square bale unloading for storage
- Lubrication-free pivot system requiring low maintenance
- Bale weighing system





Number of bales & client statistics

- Loading mode
- Unloading mode
- Manual mode
- Parameters



1
— Diagnostic & informations



Before purchasing any equipment, carefully read the technical specifications section of the product in question. Some features and options may not be available for all models.

- A) **Unique adjustable self-loading heavy duty clamp** capable of handling bales up to 1100 kg (2400 lb) without damaging twine.
- B) **Heavy duty built** provides faster bale pickup and also speed with which you can make contact with the bale
- C) **Compatible with any type of tractor**
- D) **Automated touchscreen** allows speed and ease of use from the first minutes of operating the machine
- E) **Tracking the number of bales per client** (ideal for custom operators & contractors)
- F) **Fully electronically control panel** weighs bales and total load.
- G) **Bale weighing system +/- 2.5% margin of error**
- H) **Touchscreen with self-diagnostic**
- I) **Data export to Excel via USB key**
- J) **Rugged frame and steel bed** supporting wet and dry bales.
- K) **Camera for movement in transport and unloading mode**
- L) **Tandem axle makes for stable and optimal performance of the machine.**
- M) **Designed with lubrication-free pivot system for moving parts,** the Stackpro5400 is virtually maintenance free.
- N) **Hydraulic unloading and stacking system**

THE STACKPRO SERIES

1) Danfoss touch screen

The Stackpro series is equipped with a color touch screen that allows the operator to easily supervise operations and reduce operator fatigue. The loading cycle of the Stackpro models is fully automated.

The Stackpro series are all equipped with Danfoss's "state-of-the-art" touch screen. This allows the operator to become an expert in no time for the use of the product. Simplify things by making it easy for anyone to use this product. The Danfoss touchscreen is also equipped with a "customer follow-up" menu, which tracks the number of bales loaded per field or per customer. This data can also be exported to a USB drive at the end of the day.

2) Automated loading

The loading process is fully automated. The operator only has to guide the trailer to the next bale. The loading arm has been designed to support bales up to 1089 kg (2400 lb) each. This rugged design ensures a seamless loading process under any conditions, with any square bale material. Also, the Stackpro series is equipped with sensors that allow weighing of the bales when sitting on the transition platform. This data is taken through the hydraulic lifting pressure from the bed frame.

3) Robust

Stackpro5400 and Stackpro7200 square bale trailers are extremely reliable and robust. Weighing at 22 400 lb and 25 022 lb respectively, they will last the toughest conditions. Built with a rigorous selection of electronic components, both models are equipped with Danfoss hydraulic and electronic components, making them the most reliable trailers on the market.

4) Closed hydraulic environment

All Stackpro trailers are equipped with their own hydraulic environment independent of the tractor that tows it. This increases the performance, regardless of the model of the tractor in front of him and regardless of his age. It also reduces tractor wear and eliminates hydraulic problems such as system contamination.

5) Steerable axle

Steering axles improve maneuverability and provide stability for both road and field use. In addition, they limit the skidding of the tires and therefore reduce their wear while reducing fuel consumption. The steering steering axle, orients itself in the direction given by the tractor. For driving on the road (> 15 km / h) or when reversing, a hydraulic device ensures perfect locking and alignment of the rear axle with the front axle, thus ensuring the safety of the trailer.

6) High flotation tires

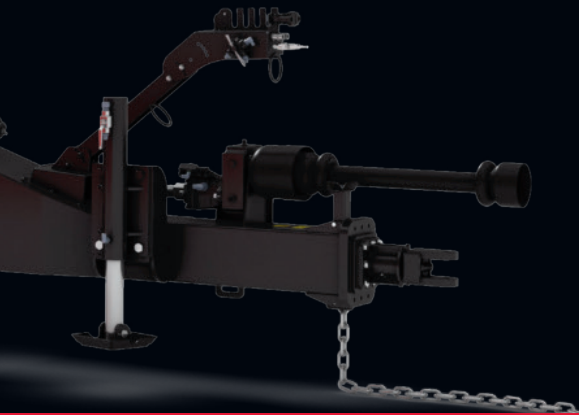

Statistics for each one of your customers



Bale weighing capacity





Touch screen monitor for ease of use



Loading arm with automatic trigger

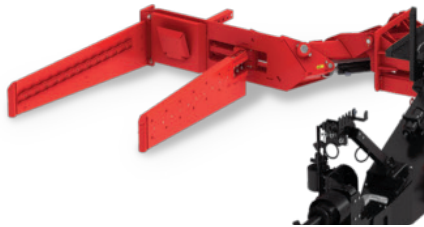

Heavy duty frame for the most demanding users



STACKPRO5400

Self-loading trailer for large square bales



Up to 51 in x 48 in x 8 ft
(128 cm x 130 cm x 240 cm)



3 double hydraulic outlets
required, free return mandatory



Angle of unloading 90 degrees



Touch screen controls



Transport capacity of
8 to 18 bales per load



HP PTO Requirement 150 HP



Unloading at 90°



Touch screen monitor for ease of use



Adjustable loading arm

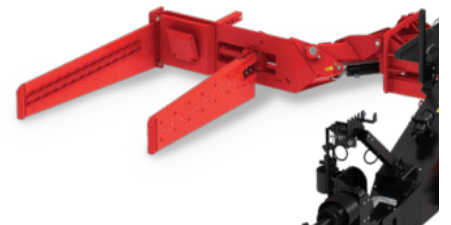

STACKPRO7200

Self-loading trailer for square bales



Up to 51 in x 48 in x 8 ft
(120 cm x 130 cm x 240 cm)



Angle of unloading 90 degrees



Transport capacity of
12 to 27 bales per load



3 double hydraulic outlets
required, free return mandatory



Touch screen controls



HP PTO Requirement 175 HP



European model shown

THE PRECISION OF THE TSR3450

The TSR3450 is an unparalleled self-loading trailer that picks up square bales quickly and efficiently. The sturdy frame and steel platform support all types of bales: silage, hay or straw. The functions are fully remotely controlled from the comfort of the tractor cab. The adjustable bale grab allows you to load different sizes of square bales.



The advantages

- Hydraulic bale pusher
- Loading and adjustable arms for different size bales
- Unloading on the ground at 35° of inclination
- High flotation tires for reduced soil compaction
- Bale receiving platform for stacking two bales tall
- Steel platform supporting wet bales
- Rear unloading extension with rollers
- Joystick type controls



Easy to use fingertip joystick controls



Adjustable loading arm for all types of bales, wet or dry



Hydraulic unloading



TSR3450

Self-loading trailer for square bales



Up to 4 ft x 4 ft x 8 ft
(120 cm x 120 cm x 240 cm)



2 double hydraulic outlets
required



Unload angle of 35 degrees



Fingertip Joystick



Transport capacity of
7 to 19 bales per load



HP PTO Requirement 130 HP



ANDERSON

FIELD THE BEST



TECHNICAL SPECIFICATIONS

		TSR3450	STACKPRO5400	STACKPRO7200
BALES	Square bale	Up to 4 ft x 4 ft (120 cm x 120 cm)	Up to 51 in x 48 in (130 cm x 120 cm)	Up to 51 in x 48 in (130 cm x 120 cm)
	Bale type	Baleage/dry hay/straw	Baleage/dry hay/straw	Baleage/dry hay/straw
SPECIFICATIONS	Tandem axle	Standard	Standard	Standard
	Tandem axle with brakes	Optional	Optional	Optional
	Self-Steering axle with brakes	N/A	Optional	Optional
	Safety chain	Standard - clevis hitch	Standard & Ball joint towing eye	Standard & Ball joint towing eye
	Self-loading arm design	Hydraulic clamp	Hydraulic clamp	Hydraulic clamp
	Able to load a second row of bales	Scissor platform	Platform	Platform
	Tires	560/45-R22.5	560/45-R22.5	560/45-R22.5
	Backup camera	n/a	Standard	Standard
	Tractor Minimum Hydraulic Flow	9 gal/min (30 L/min)	21 gal/min (80 l/min)	21 gal/min (80 l/min)
	Tractor Minimum Hydraulic Pressure	2500 psi (172 bar)	2800 psi (190 bar)	2800 psi (190 bar)
	HP requirements	130 HP	150 HP	175 HP
	Tractor Remote outlets required	2	3 + 3/4" free return mandatory Or 4 + 3/4" free return if steering axle option	3 + 3/4" free return mandatory Or 4 + 3/4" free return if steering axle option
	PTO Speed / PTO shaft	N/A	1000 RPM/13/4-Z20	1000 RPM/13/4-Z20
Controls	Fingertip joystick	Touchscreen	Touchscreen	
DIMENSIONS	Width - A	8 ft 6 in (2,6 m)	8 ft 4 in (2,55 m)	8 ft 4 in (2,55 m)
	Overall width (including loading arm)	9 ft 10 in (3 m)	8 ft 4 in (2,55 m)	8 ft 4 in (2,55 m)
	Height - B	7 ft 10 in (2,4 m)	12 ft 8 in (3,86 m)	12 ft 8 in (3,86 m)
	Overall height (including loading arm)	9 ft 10 in (3 m)	12 ft 8 in (3,86 m)	12 ft 8 in (3,86 m)
	Bed height - E	4 ft 7 in (1,4 m)	6 ft 1 in (1,85 m)	6 ft (1,83 m)
	Overall length - D	37 ft 9 in (11,5 m)	35 ft 7 in (10,85 m)	39 ft (11,91 m)
	Overall weight	13 650 lb (6200 kg)	22 400 lb (10 160 kg)	25 022 lb (11 350 kg)
	Empty weight on tow bar	4530 lb (2055 kg)	3650 lb (1655 kg)	2782 lb (1261 kg)

Specifications and dimensions are subject to change without notice.



BALE LOADING CAPACITY AND SPEED

		TSR3450	STACKPRO5400	STACKPRO7200			
CAPACITY	Square bale 3 ft x 3 ft x 8 ft long (90 cm x 90 cm x 2,4 m)	19	18	27			
	Square bale 4 ft x 3 ft x 8 ft long (1,2 m x 90 cm x 2,4 m)	14	12	16			
	Square bale 4 ft x 4 ft x 8 ft long (1,2 m x 1,2 m x 2,4 m)	7	8	12			
	Loading arm lifting capacity	2200 lb (1000 kg)	2400 lb (1089 kg)	2400 lb (1089 kg)			
	Total weight including load	42 000 lb (19 000 kg)	42 000 lb (19 000 kg)	42 000 lb (19 000 kg)			
BALES TRANSPORTED / HOUR		3' X 3'	3' X 4'	3' X 3'	3' X 4'	3' X 3'	3' X 4'
	On a distance of 0,62 mile (1 km)	75	65	90	72	108	85
	On a distance of 1,24 mile (2 km)	55	45	66	50	84	61
	On a distance of 1,86 mile (3 km)	43	34	52	39	68	48
	On a distance of 2,48 miles (4 km)	36	27	43	31	58	39
	On a distance of 3,10 miles (5 km)	30	23	37	26	50	33

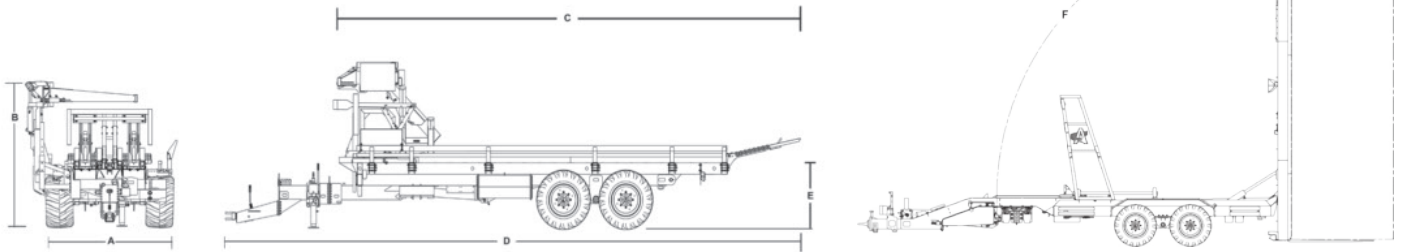

TIRES

DIMENSIONS	RIMS	WIDTH	DIAMETER	MAX LOAD PER WHEELS AT 40 KM/H	INFLATION PRESSURE	PLYS
400/60-22.5	22.5	16 in (400 mm)	42,1 in (1070 mm)	4000 kg (8820 lb)	51 psi (3,5 bar)	16
560/45-R22.5	22.5 x 16.00	21,4 po (543 mm)	42,4 po (1076 mm)	4825 kg (10635 lb)	58 psi (4 bar)	SB (steel belt)



ANDERSON

PRO-CHOP 150

ANDERSON

PRO-CHOP 150



ANDERSON

**BALE
PROCESSOR**





WHY USE A BALE PROCESSOR?

The PRO-CHOP 150, both feeder and blower, is the ideal bedding or feeding solution for hay bales, straw and silage.

The Anderson bale processor is the only machine able to chop different types of forage in different lengths: full-length silage up to 5 in, hay up to 3 in and straw up to 1 in.

The PRO-CHOP 150 is equipped with a hatch under the frame at the back of the machine, to clean foreign bodies or other debris. It can also be opened for cleaning residual build-up without removing the fan or opening the machine. This machine is perfect for square and round bales!



The advantages

- The blower's chute makes distribution in troughs, near the machine, very precise and comfortable.
- It allows spreading up to 60 ft on the right and 40 ft on the left.
- For bedding, livestock is cleaner and healthier and the straw is finely chopped to increase moisture absorption.



Before purchasing any equipment, carefully read the technical specifications section of this product. Some features and options may be incompatible with some models and not available in some countries. For more information, please contact your authorized Anderson dealer.

The different cutting settings

The Pro-chop 150 offers four possible settings, change settings without tools in less than 15 seconds.

- A) The top gate engaged**
When engaged, the gate is used to help cut more fiber efficiently.
- B) The top gate disengaged**
When disengaged, the door allows the fibers to pass through without cutting them.
- C) The counter knife**
It is used to cut the material more finely.
- D) The removable recutter screen**
It is used ONLY during the treatment of the straw. With its different size holes, it lets only short fibers pass and longer ones will be forced to return to the knives.
- E) The comb**
They are part of the rotor and allow the bales to be perfectly absorbed through the rotor. They also prevent the bales from coming into contact too quickly with the rotor and create
- F) The cut**
Chop different types of forage in various lengths: full-length silage up to 5 in, hay up to 3 in and straw up to 1in.

QUICK AND EASY DISTRIBUTION

1) Better distribution

This makes distribution near the machine very precise and comfortable. It allows spreading up to 60 ft (18.2 m) on the right and 40 ft (12.19 m) on the left. For bedding, the straw is finely ground to increase its absorbency to moisture. By improving the comfort of cows, the risks of mastitis and health disorders are reduced, livestock remains cleaner. For feeding, it is easy to feed troughs as well as pretreat the straw for RTM mixers. Consumption is then increased and waste is reduced.

2) Viewing cameras

The indoor camera allows you to see the bales on the conveyor, the rotor and the load. The new reversing cameras offer a perfect view of the load and the tank.

3) Large loading capacity

The 5' chamber can be used with all bale sizes. It has the capacity to hold up to two bales (1 X 6 ft round, 2 X 5 ft round and 1 square bale up to 4 ft X 4 ft X 9 ft (1.21 m X 1.21 m X 2.74 m) reducing the possibility of overflowing. The loading of the bales is done by the rear door with the help of the a camera. In the case where two bales are loaded the loading door allows a bale to be placed while the other one shreds at the back inside.

4) Large wheels for muddy terrain

As for all of our machines, we expect them to serve you no matter the conditions. We have equipped the Pro-chop 150 with high-flotation wheels that will save you worries in soft ground.

5) Even more controls

The electrical controls of the loading door allow the user to operate the conveyor as well as to open and close the door. Convenient, in case a bale is not placed properly or to remove the net or string at the beginning of the process. No need to return to the tractor: everything can be done directly next to the machine.

6) Optimal cutting

The rotor is equipped with 264 knives and 22 heavy-duty discs that can shred round or square silage bales, hay or straw. Even frozen bales will have no problem being treated. Its diameter ensures a constant flow.

7) Hose adapter 10 inches

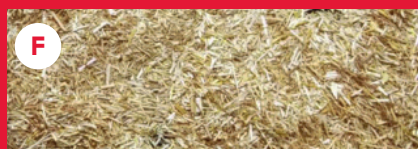
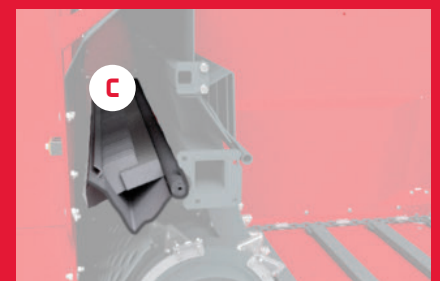
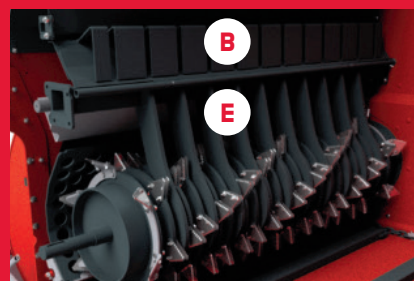
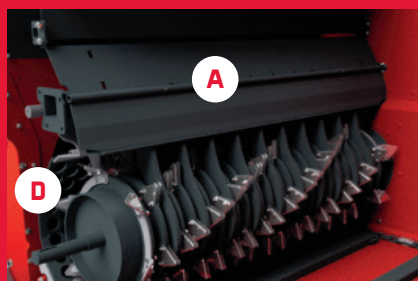



PRO-CHOP 150

Bale processor



1 bale up to 6 ft x 5 ft long (1.9 m x 1.5 m)
2 bales up to 5 ft x 5 ft long (1.5 m x 1.5 m)



Hay, silage and straw bales



1 bale of 4 ft x 4 ft x 9 ft (1.2 m x 1.3 m x 2.8 m)



HP PTO Requirement 80 HP

TECHNICAL SPECIFICATIONS

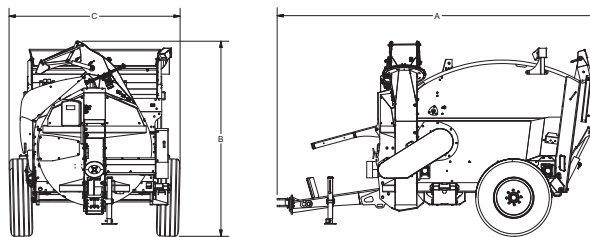

		PRO-CHOP 150
BALES	Type of bales	Straw/hay/baleage
	Round Bale Capacity	1 bale up to 6 ft x 5 ft long (1,9 m x 1,5 m) or 2 bales up to 5 ft x 5 ft long (1,5 m x 1,5 m)
	Square Bale Capacity	4 ft x 4 ft x 9 ft (1,2 m x 1,3 m x 2,8 m)
	Maximum bale(s) weight	2755 lb (1250 kg)
SPECIFICATIONS	Maximum discharge distance	Up to 60 ft (18 m) on the right side and up to 40 ft (12 m) on the left side
	Controls	Electrical with conveyor speed adjustment
	Chute rotation	270°
	Tires	315 x 80 R 22,5 L
	Tractor mounting	Double plate hitch
	Number of blower paddles	8
	Number of knives	264
	Number of discs on rotor	22
	Tractor Minimum Hydraulic Flow	5,5 gal/min (20 l/min)
	Tractor Minimum Hydraulic Pressure	2900 psi (200 bar)
	Tractor Minimum HP requirements	80 HP
Tractor hydraulic requirements	1	
PTO requirement	540 RPM	
DIMENSIONS	Overall width (m)	14 ft 10 in (4,52 m)
	Overall height (m)	8 ft 11 in (2,71 m)
	Overall length (m)	7 ft 11 in (2,41 m)
	Overall weight (kg)	6615 lb (3000 kg)
	Bale chamber (W x H x L)	5 ft 5 in x 3 ft 11 in x 6 ft 7 in (1,65 m x 1,20 m x 2 m)
	Bale chamber capacity	152 ft³ (4 m³)

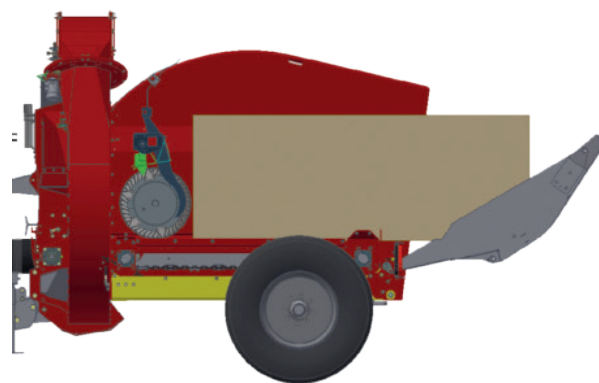
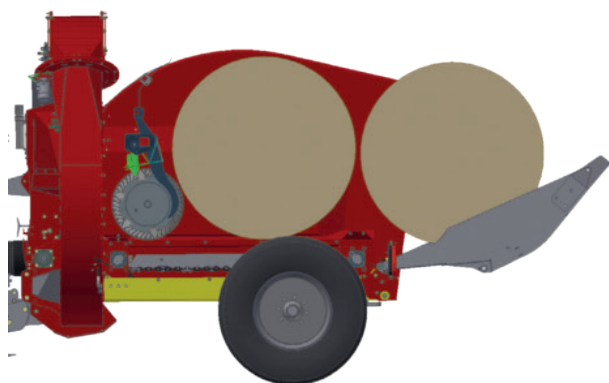





VERTICAL TMR MIXERS





UNIQUE DESIGN

The choice of mixer is crucial to the success of your business. The unique design of the augers and the tank have been designed to obtain optimal mix. Whether you incorporate round or square bales, silage or supplements into your ration, Anderson mixers will help you reach your nutrition goals.

They will save you time and money with each use. Day after day, the robustness and efficiency of the Anderson Smartmix mixer will surprise you.



SMARTMIX™ vertical mixers

- Process and mix large amounts of hay, round bales, square bales and silage bales.
- Produces a homogeneous blend of optimal quality every time
- Available with several unloading options for uniform unloading
- Uses a simple drive system
- Hydraulically controlled restriction blades (fastest bale processing mixer on the market)
- The required HP power is reduced to a minimum.
- Silent belt conveyors operating at very high speed (faster unloading)



ANDERSON
SMARTMIX
A700

WHAT SETS US APART

A mixer is one of the most stressed machines on your farm. Day after day, it will be subjected to very great friction coming from the fodder in movement against its auger and its tub. For greater durability, we manufacture our machines with a steel that offers a very high resistance to abrasion. This steel is of Hardox type. This stronger and more durable steel is widely used in the industrial and mining sectors. We manufacture the floor of the tub, walls and the vertical auger with AR235 steel. This unparalleled steel configuration will provide an unbeatable life for your mixer.



BRINELL STEEL CHART

118-167	A36
134-178	44w
141	Cor-ten
185-235	AR235 

Benefits of a rolled tub SMARTMIX™

We designed our tubs with rolled walls (not bent) giving them the following advantages:

- The walls of our SMARTMIX™ tank are rolled at their ends. With this folding-free manufacturing process, we get completely smooth sides that allow to minimize friction and improve the circulation of material in the tank.
- With each ration, you will quickly obtain a homogeneous mix regardless of the quantity to be mixed.
- In addition to increasing the yield of your herd, you will save energy when preparing your mix.
- The monobloc tank floor without joints is reinforced to absorb load constraints.
- The Smartmix tank wall joints overlap and are then bolted and welded for rock solid strength.



Before purchasing any equipment, carefully read the technical specifications section of the product in question. Some features and options may not be available for all models.

Capacity extensions

Adding steel capacity extensions will get you to the desired level of production, unlike rubber extensions that break and crack, and cause replacement costs year after year.

- Height of 6 in, 12 in and 18 in.
- Possibility of adding a retention ring, this option can be bolted directly to the metal extension or to the tank itself. This addition to your mixer will allow you to avoid overflowing the material as well as reduce the time to process your round bales.

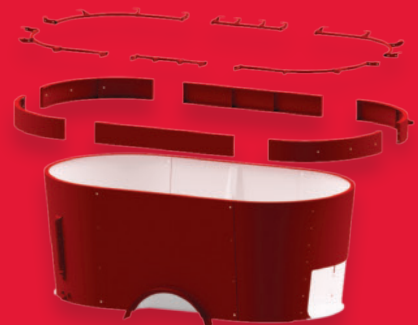

STRENGTH AND LONGEVITY

THE BEST OF BOTH WORLDS

1) TRUE-CUT™ : Restriction blade system

Anderson presents its hydraulically controlled restriction blades (optional). Thanks to them, the operator can activate and remove the blades during the mixing process, reducing the required time by up to 22 %, while preserving the integrity of ingredients such as silage and grains .When the blade is fully engaged, at 8 in, the treatment of long fibers is accelerated by 50 %. Once the fiber is processed according to the recipe, the restriction blade can be removed, eliminating the risk of over-grinding the other ingredients. The complete control of the assimilation of your cows is ensured during their feeding, which increases milk production by 5 % with the same cost of food. Mechanical restriction blades are installed standard on all our TMR Smartmix mixers.

2) Auger extension : exclusive to Anderson

With a height of 14 in and equipped with two additional knives, this boltable extension can be installed on the majority of our mixers (usually used with an 18 in extension). This exclusive Anderson option allows you to keep the same height relationship between the auger and the walls when adding tub extension. Even if you add more volume to the inside of the tub, the material on the top will still be mixed thanks to the horizontal and vertical movement caused by the auger extension. This option also allows you to advance the capacity of your mixer while tracking the evolution of your herd.

3) Inspection and maintenance hatch

Each of the auger is provided with an inspection hatch to clean the inside of the auger in order to check if the planetaries have sufficient lubrication. It also allows better access for mechanical interventions.

4) Magnet on the auger

The neodymium magnet can be optionally installed on the back of the sweeper of our augers. Being always in contact with the material during the mixing process and during unloading, this magnet provides excellent efficiency at all times.

5) Tungsten carbide knives

The tungsten carbide knives last three times longer than the competition. With a Rockwell hardness of 45, they sharpen automatically and ensure a perfect cutting quality day after day. Installed in standard on each auger, they are adjustable in two positions and reversible, thus doubling their lifespan. Thanks to their oversized and very aggressive serrated blades, they offer exceptional performance for round or square bales. Each knife is equipped with a reinforcement plate to absorb the impacts of round bales when thrown into the tub.

6) Sweepers

Often optional on competition models, our sweepers are installed and welded on the base of our augers as a standard. The ssweepers provide additional material movement during mixing and unloading 30 % faster and more uniformly than machines without this equipment.

7) Axles

Depending on the distances traveled and the type of terrain, you can choose to keep the single axle tandem or tridem self-steering depending on the model chosen.

Planetaries

Each planetary was carefully chosen based on uniqueness of each model and the most extreme working conditions on the market.

In the component selection process, Anderson has worked closely with Comer's engineers to ensure product excellence, and to provide you with peace of mind and an excellent warranty.



THE ADVANTAGES OF THE TRI-CUT™ AUGER

- Spiral-shaped augers lift the material vertically, creating the “up and down” effect. The rotation of the auger also provides a “forward / backward” effect to the cycle.
- The upward movement of the feed combined with the downward movement along the tub wall provides perfect mixing.
- The unique triangular position of the Anderson knives around the auger allows you to quickly process all types of bales, even frozen, and speed up the flow of material.
- Anderson offers an AR235 high strength steel augers.
- The cutting blades are reinforced to avoid breaking in cold conditions or when processing frozen bales.
- The small distance between the interior walls and the screw has the advantage of creating a very large displacement of the ingredients in the tank. The upward movement of the feed to the combined medium downward movement along the wall of the tub provides a total ration with a perfectly homogeneous mix.

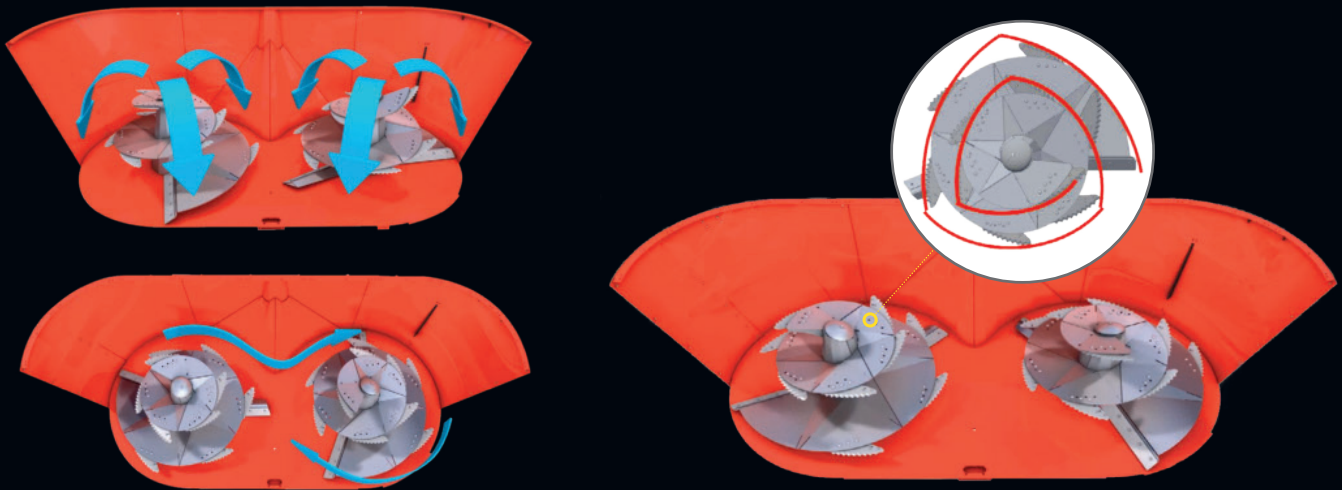

Knives, the part that must not be overlooked.

The wear and tear of knives over the life of a machine is an expense that should not be overlooked. Here are some advantages of Anderson knives:

- Price 30 to 50 % cheaper than the competition!
- Tungsten carbide three times more durable
- Automatic sharpening and perfect cutting quality
- Reversible, they have a double lifespan
- Aggressive oversized serrated blade
- Installed on reinforcement plate to absorb bale impacts



SMARTMIX™
THE OPTIMAL QUALITY!



ANDERSON

FIELD THE BEST



UNLOADING METHODS

Front conveyor

The conveyor is positioned at the front of the mixer tub. This provides the visibility needed to adjust the amount to be dispensed. The conveyor is recommended for fibrous rations; its length allows you to easily adjust the delivery rate. Thanks to its design, feed can be distributed to the left or to the right. The conveyor is driven by a hydraulic motor at each end, which ensures perfect operation regardless of the unloading direction. It can also move away, creating greater proximity between the machine and the unloading point.

Our belts are the best on the market with a larger speed range allowing them better control over the projection of material. The strips are vulcanized on the belt instead of being glued. The manufacturing technology allows a very long life of the belt before having to replace it. Designed to work even at -40 degrees C. It also ensures that the forage does not return below to create blockages so the feed passage is always clean after distribution. The range can also be equipped with a wide range of hydraulically inclined conveyors to distribute the ration in troughs.



Chain conveyor

We use CA620 roller chain on our conveyor chain. CA620 roller chain is commonly known as CA620 agricultural roller chain and is manufactured using hardened steel parts to close tolerances. The chain is manufactured to American Standards and has been utilized within the industry for many years. This CA620 roller chain is durable, high quality, high strength, and has a long working life.

- Sprockets are 3/4 in thick and they are made from hardened steel.
- Conveyors can operate at very high speed compared to competitor conveyors.
- They are silent compared to competitor conveyors thanks to the high density plastic pads installed at the path and at the return of the chain.
- Horizontal conveyor operable in both directions (left or right feed).
- Automatic tensioning system that ensures the correct chain tension at all times.
- Sealing system that minimizes material losses to the ground
- Guaranteed start-up at all times even in winter conditions (snow and ice).

Side traps

These distribution traps allow fast and easy unloading of feed at the level of the ground without blockages. Distribution traps can be mounted according to demand on the front right or rear left. They are ideal for distribution in all types of building configurations.



MORE FUNCTIONAL COMPUTER

OFFERED BY SMARTMIX™

DG500 weight indicator computer

Delivered as standard and compatible with the DTM suite, the DG500 computer is a universal weighing indicator. It allows the programming of recipes and distribution as well as the storage of data. It guarantees extremely precise weighing thanks to the protected load cells, distributed strategically under the tank.

The interface is composed of a dual LCD that makes it clear. The software allows you to program 24 recipes that can contain 48 components and 48 different distribution points, to configure the component names, the distribution points and the program in your own language and to classify the programs by "quantity", "total" or "number of animals". The "total" or "number of animals" loading can be placed before the run, in order to have a program that is always in accordance with the needs of the animal.

Mobile application

The dina TEL 3 app is the ultimate technology that brings weight indicator control to your smartphone or tablet. By installing the app, you can turn your phone into a weight indicator and make the charging process more efficient.



Weight display repeater screen

- The weight repeater makes it possible to have a second display directed towards the operator who loads the ingredients into the mixer.
- The main computer remains in place for the tractor driver.





ANDERSON[®]
SOLUTIONS FOR SMARTER FARMS





A280

Single auger vertical TMR mixer



Capacity of 280 ft³ (7.9 m³)
to 388 ft³ (11 m³)



HP PTO Requirement
in high speed: minimum 60 HP



Height of 98 in (2.49 m)
to 116 in (2.95 m) with extension



Unloading the material
by side trap



1 auger with 6 reversible knives
in carbide tungsten (10 knives per auger,
optional)





A380

Single auger vertical TMR mixer



Capacity of 380 ft³ (10.8 m³)
to 500 ft³ (14.2 m³)



HP PTO Requirement
in low speed: minimum 50 HP
in high speed: minimum 75 HP



Height of 106 in (2.69 m)
to 124 in (3.15 m) with extension



Unloading the material by
side trap or front conveyor



1 auger with 6 reversible knives
in carbide tungsten (10 knives per auger,
optional)



A450

Single auger vertical TMR mixer



Capacity from 450 ft³ (12.8 m³)
to 600 ft³ (17 m³)



HP PTO Requirement
in low speed: minimum 60 HP
in high speed: minimum 85 HP



Height of 112 in (2.84 m)
to 130 in (3.3 m) with extension



Unloading the material by
side trap or front conveyor



1 auger with 8 reversible knives
in carbide tungsten (12 knives per auger,
optional)





A520

Twin auger vertical TMR mixer



Capacity of 520 ft³ (14.7 m³)
to 682 ft³ (19.3 m³)



HP PTO Requirement
in low speed: minimum 80 HP
in high speed: minimum 120 HP



Height of 102 in (2.59 m)
120 in (3.05 m) with extension



Unloading the material by
side trap or front conveyor



2 augers with 6 reversible knives each
in carbide tungsten (10 knives per auger,
optional)





A700

Twin auger vertical TMR mixer

Model presented with tandem axle (optional)



Capacity 700 ft³ (19.8 m³)
to 910 ft³ (25.8 m³)



HP PTO Requirement
in low speed: minimum 100 HP
in high speed: minimum 150 HP



Height of 110 in (2.79 m)
to 128 in (3.25 m) with extension



Unloading material by side trap or front conveyor



2 augers with 6 reversible knives each
in carbide tungsten (10 knives per auger,
optional)





A920

Twin auger vertical TMR mixer

Model presented with tandem axle (optional)



Capacity 920 ft³ (26.1 m³)
to 1172 ft³ (33.2 m³)



HP PTO Requirement
in low speed: minimum 100 HP
in high speed: minimum 150 HP



Height of 122 in (3.1 m)
to 140 in (3.56 m) with extension



Unloading material by side trap or front conveyor



2 augers with 8 reversible knives each
in carbide tungsten (12 knives per auger,
optional)





A950

Triple auger vertical TMR mixer

Model presented with tridem axle (optional)



Capacity 920 ft³ (26.1 m³)
to 1211 ft³ (34.3 m³)



HP PTO Requirement
in low speed: minimum 120 HP
in high speed: minimum 180 HP



Height 117 in (2.97 m)
to 135 in (3.43 m) with extension



Unloading the material
by front conveyor



3 augers with 6 reversible knives each
in carbide tungsten (10 knives per auger,
optional)





A1230

Triple auger vertical TMR mixer



Capacity of 1230 ft³ (34.9 m³)
to 1572 ft³ (44.5 m³)



HP PTO Requirement
in low speed: minimum 145 HP
in high speed: minimum 210 HP



Height 117 in (2.97 m)
135 in (3.43 m) with extension



Unloading the material
by front conveyor



3 augers with 8 reversible knives each
in carbide tungsten (12 knives per auger,
optional)

TECHNICAL SPECIFICATIONS

		A280ST SINGLE AUGER	A380ST SINGLE AUGER	A380FD SINGLE AUGER
CAPACITY	Capacity (no capacity extension)	280 ft ³ (7.9 m ³)	380 ft ³ (10.8 m ³)	380 ft ³ (10.8 m ³)
	6 in capacity extension	316 ft ³ (9 m ³)	420 ft ³ (11.9 m ³)	420 ft ³ (11.9 m ³)
	12 in capacity extension	352 ft ³ (10 m ³)	460 ft ³ (13 m ³)	460 ft ³ (13 m ³)
	18 in capacity extension	388 ft ³ (11 m ³)	500 ft ³ (14.2 m ³)	500 ft ³ (14.2 m ³)
	Number of Auger	1	1	1
DIMENSIONS	Length (A)	176 in (4.46 m)	189 in (4.79 m)	217 in (5.51 m)
	Height (B) no extension	98 in (2.49 m)	106 in (2.69 m)	106 in (2.69 m)
	6 in capacity extension	104 in (2.64 m)	112 in (2.84 m)	112 in (2.84 m)
	12 in capacity extension	110 in (2.79 m)	118 in (3 m)	118 in (3 m)
	18 in capacity extension	116 in (2.95 m)	124 in (3.15 m)	124 in (3.15 m)
	Hay retention ring (additional height)	0 in / 3.5 in	0 in / 3.5 in	0 in / 3.5 in
	Width (C)			
	Without incline conveyor	90 in (2.29 m)	101 in (2.57 m)	101 in (2.57 m)
	With incline conveyor (retracted)	106 in (2.69 m)	117 in (2.97 m)	117 in (2.97 m)
	Incline conveyor operating angle (degrees)	26 @39 degrees	26 @39 degrees	26 @39 degrees
	Outside width of the wheels	86 in (2.18 m)	86 in (2.18 m)	86 in (2.18 m)
	Lateral distance to discharge point (D) at min.26 angle /max 40			
	Incline conveyor chain / belt 3 ft	36-29in at 26° / 33-26in at 40°	30-23in at 26° / 27-20in at 40°	30-28in at 26° / 28-25in at 40°
	Incline conveyor chain / belt 4 ft	45-38in at 26° / 40-33in at 40°	39-32in at 26° / 35-28in at 40°	38-36in at 26° / 35-32in at 40°
	Incline conveyor chain / belt 5 ft	59-52in at 26° / 53-46in at 40°	53-46in at 26° / 47-40in at 40°	53-51in at 26° / 48-45in at 40°
	Incline conveyor chain / belt 6 ft	68-61in at 26° / 60-53in at 40°	62-55in at 26° / 55-48in at 40°	62-60in at 26° / 55-52in at 40°
	Incline conveyor chain / belt 7 ft	82-75in at 26° / 73-66in at 40°	76-69in at 26° / 67-60in at 40°	76-74in at 26° / 67-64in at 40°
	Incline conveyor chain / belt 8 ft	91-84in at 26° / 80-73in at 40°	85-78in at 26° / 74-67in at 40°	85-83in at 26° / 75-72in at 40°
	Discharge height (E)			
	Incline conveyor chain / belt 3 ft	32-36in at 26° / 41-41in at 40°	37-41in at 26° / 46-46in at 40°	35-37in at 26° / 42-42in at 40°
	Incline conveyor chain / belt 4 ft	36-40in at 26° / 47-47in at 40°	41-45in at 26° / 52-52in at 40°	39-41in at 26° / 48-48in at 40°
	Incline conveyor chain / belt 5 ft	43-47in at 26° / 57-57in at 40°	48-52in at 26° / 63-63in at 40°	46-48in at 26° / 59-59in at 40°
	Incline conveyor chain / belt 6 ft	47-51in at 26° / 64-64in at 40°	53-57in at 26° / 69-69in at 40°	50-52in at 26° / 65-65in at 40°
Incline conveyor chain / belt 7 ft	54-58in at 26° / 74-74in at 40°	60-64in at 26° / 79-79in at 40°	57-59in at 26° / 75-75in at 40°	
Incline conveyor chain / belt 8 ft	59-63in at 26° / 80-80in at 40°	64-68in at 26° / 85-85in at 40°	61-63in at 26° / 82-82in at 40°	
Floor ST (E1) / Conveyor FD (E2) to ground	30in(0.77m)	36in(0.91m)	26in(0.66m)	
SPECIFICATIONS	PTO shaft - Standard specification	540 RP m 1" 3/8 Z6	540 RP m 1" 3/8 Z6	540 RP m 1" 3/8 Z6
	PTO shaft - Option specification	N/A	1000 RP m 1" 3/8 Z21	1000 RP m 1" 3/8 Z21
	2 speed Gear Box	N/A	Optional	Optional
	2 Speed Gear Box and ratio	N/A	0732, 1:1.5 540 RPM	0732, 1:1.5 540 RPM
	Minimum PTO HP Requirement - Low Speed	N/A	50	50
	Minimum PTO HP Requirement - High Speed	60	75	75
	Auger RPM - Low Speed	N/A	27 RPM	27 RPM
	Auger RPM - Standard High speed	41 RPM	41 RP M	41 RPM
	Standard planetary model and ratio configuration	1602 @13.4	1602 @13.4	1602 @13.4
	Optional Planetary	N/A	N/A	N/A
	Floor Thickness (AR235 grade or equivalent)	5/8 in	3/4 in	3/4 in
	Sidewall Thickness (AR235 grade or equivalent)	1/4 in	1/4 in	1/4 in
	Flighting Thickness (AR235 grade or equivalent)	5/8 in	5/8 in	5/8 in
	Standard knives per auger	6 / 10 optional	6 / 10 optional	6 / 10 optional
	Driveline security	Shear bolt	Shear bolt	Shear bolt
	Hydraulic flow requirement	10-15 US gal/ m in 37-56 L/ m in	10-15 US gal/ m in 37-56 L/ m in	10-15 US gal/ m in 37-56 L/ m in
	Hydraulic pressure	160-200 bar (2300-2900 psi)	160-200 bar (2300-2900 psi)	160-200 bar (2300-2900 psi)
	Load cell	3	3	3
	Scale system	06500 (standard)	06500 (standard)	06500 (standard)
	Machine Weight (empty) - STD configuration	7067 lb (3205 kg)	8465 lb (3839 kg)	9707 lb (4402 kg)
Utility load capacity	8120 lb (3683 kg)	11 020 lb (4998 kg)	11 020 lb (4998 kg)	
Axle - Standard specifications	Single	Single	Single	
Axle - Optional specifications	N/A	N/A	N/A	
Wheels - Standard specifications	15.0/55-17 26 PLY	15.0/55-17 26 PLY	15.0/55-17 26 PLY	

Specifications and dimensions are subject to change without notice.

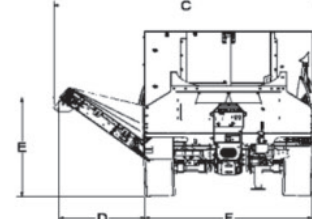
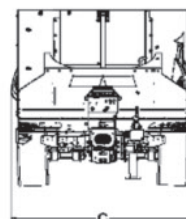
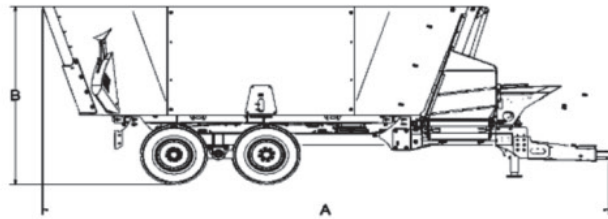

A450ST /HT SINGLE AUGER	A450FD SINGLE AUGER	A520ST TWIN AUGER	A520FD TWIN AUGER
450 ft ³ (12.8 m ³)	450 ft ³ (12.8 m ³)	520 ft ³ (14.7 m ³)	520 ft ³ (14.7 m ³)
500 ft ³ (14.2 m ³)	500 ft ³ (14.2 m ³)	574 ft ³ (16.3 m ³)	574 ft ³ (16.3 m ³)
550 ft ³ (15.6 m ³)	550 ft ³ (15.6 m ³)	628 ft ³ (17.8 m ³)	628 ft ³ (17.8 m ³)
600 ft ³ (17 m ³)	600 ft ³ (17 m ³)	682 ft ³ (19.3 m ³)	682 ft ³ (19.3 m ³)
1	1	2	2
190 in (4.84 m)	219 in (5.57 m)	242 in (6.15 m)	270 in (6.86 m)
112 in (2.84 m)	112 in (2.84 m)	102 in (2.59 m)	102 in (2.59 m)
118 in (3 m)	118 in (3 m)	108 in (2.74 m)	108 in (2.74 m)
124 in (3.15 m)	124 in (3.15 m)	114 in (2.9 m)	114 in (2.9 m)
130 in (3.3 m)	130 in (3.3 m)	120 in (3.05 m)	120 in (3.05 m)
0 in / 3.5 in	0 in / 3.5 in	0 in / 3.5 in	0 in / 3.5 in

112 in (2.84 m)	112 in (2.84 m)	101 in (2.57 m)	101 in (2.57 m)
125 in (3.18 m)	124 in (3.15 m)	115 in (2.92 m)	117 in (2.97 m)
26 @39 degrees	26 @39 degrees	226 @39 degrees	26 @39 degrees
86 in (2.18 m)	86 in (2.18 m)	99 in (2.51 m)	99 in (2.51 m)

23-16in at 26° / 20-13in at 40°	23-21in at 26° / 21-18in at 40°	29-22in at 26° / 27-20in at 40°	30-28in at 26° / 28-25in at 40°
32-25in at 26° / 28-21in at 40°	31-29in at 26° / 28-25in at 40°	38-31in at 26° / 35-28in at 40°	38-36in at 26° / 35-32in at 40°
47-40in at 26° / 40-33in at 40°	46-44in at 26° / 41-38in at 40°	53-46in at 26° / 47-40in at 40°	53-51in at 26° / 48-45in at 40°
56-49in at 26° / 47-40in at 40°	55-53in at 26° / 48-45in at 40°	62-55in at 26° / 55-48in at 40°	62-60in at 26° / 55-52in at 40°
71-64in at 26° / 60-53in at 40°	69-67in at 26° / 60-57in at 40°	77-70in at 26° / 67-60in at 40°	76-74in at 26° / 67-64in at 40°
80-73in at 26° / 67-60in at 40°	78-76in at 26° / 68-65in at 40°	86-79in at 26° / 75-68in at 40°	85-83in at 26° / 75-72in at 40°

36-40in at 26° / 46-46in at 40°	35-37in at 26° / 42-42in at 40°	34-38in at 26° / 44-44in at 40°	33-35in at 26° / 40-40in at 40°
40-44in at 26° / 53-53in at 40°	39-41in at 26° / 48-48in at 40°	38-42in at 26° / 51-51in at 40°	37-39in at 26° / 46-46in at 40°
46-50in at 26° / 63-63in at 40°	46-48in at 26° / 59-59in at 40°	44-48in at 26° / 61-61in at 40°	44-46in at 26° / 57-57in at 40°
50-54in at 26° / 69-69in at 40°	50-52in at 26° / 65-65in at 40°	48-52in at 26° / 67-67in at 40°	48-50in at 26° / 63-63in at 40°
56-60in at 26° / 79-79in at 40°	57-59in at 26° / 75-75in at 40°	54-58in at 26° / 77-77in at 40°	55-57in at 26° / 73-73in at 40°
60-64in at 26° / 85-85in at 40°	61-63in at 26° / 82-82in at 40°	58-62in at 26° / 84-84in at 40°	59-61in at 26° / 80-80in at 40°
36 in (0.91m)	26 in (0.66m)	34 in (0.85m)	24 in (0.61m)

540 RP m 1" 3/8 Z6	540 RP m 1" 3/8 Z6	540 RP m 1" 3/8 Z6	540 RP m 1" 3/8 Z6
1000 RP m 1" 3/8 Z21	1000 RP m 1" 3/8 Z21	1000 RP m 1" 3/8 Z21	1000 RP m 1" 3/8 Z21
Optional	Optional	Optional	Optional
0732, 1:1.5 540 RPM	0732, 1:1.5 540 RPM	C3A-R, 1:1.5 540 RPM C3A-R, 1.8:2.7 1000 RPM	C3A-R, 1:1.5 540 RPM C3A-R, 1.8:2.7 1000 RPM
60	60	80	80
85	85	120	120
27 RPM	27 RPM	27 RPM	27 RPM
41 RPM	41 RPM	41 RPM	41 RPM
1602 @13.4	1602 @13.4	1602 @13.4	1602 @13.4
N/A	N/A	N/A	N/A
3/4 in	3/4 in	5/8 in	5/8 in
1/4 in	1/4 in	1/4 in	1/4 in
5/8 in	5/8 in	5/8 in	5/8 in
8 / 12 optional	8 / 12 optional	6 / 10 optional	6 / 10 optional
Shear bolt	Shear bolt	Shear bolt	Shear bolt
10-15 US gal/ m in 37-56 L/ m in	10-15 US gal/ m in 37-56 L/ m in	10-15 US gal/ m in 37-56 L/ m in	10-15 US gal/ m in 37-56 L/ m in
160-200 bar (2300-2900 psi)	160-200 bar (2300-2900 psi)	160-200 bar (2300-2900 psi)	160-200 bar (2300-2900 psi)
3	3	3	3
06500 (standard)	06500 (standard)	06500 (standard)	06500 (standard)
8765 lb (3975 kg)	10 007 lb (4538 kg)	11 744 lb (5326 kg)	13 100 lb (5941 kg)
13 050 lb (5918 kg)	13 050 lb (5918 kg)	15 000 lb (6839 kg)	15 000 lb (6839 kg)
Single	Single	Single	Single
N/A	N/A	N/A	N/A
15.0/55-17 26 PLY	15.0/55-17 26 PLY	385/65R22.5-20	385/65R22.5-20

TECHNICAL SPECIFICATIONS

		A700ST TWIN AUGER	A700FD TWIN AUGER
CAPACITY	Capacity (no capacity extension)	700 ft ³ (19.8 m ³)	700 ft ³ (19.8 m ³)
	6 in capacity extension	770 ft ³ (21.8 m ³)	770 ft ³ (21.8 m ³)
	12 in capacity extension	840 ft ³ (23.8 m ³)	840 ft ³ (23.8 m ³)
	18 in capacity extension	910 ft ³ (25.8 m ³)	910 ft ³ (25.8 m ³)
	Number of Auger	2	2
DIMENSIONS	Length (A)	288 in (7.32 m)	309 in (7.86 m)
	Height (B) no extension	110 in (2.79 m)	110 in (2.79 m)
	6 in capacity extension	116 in (2.95 m)	116 in (2.95 m)
	12 in capacity extension	121 in (3.07 m)	121 in (3.07 m)
	18 in capacity extension	128 in (3.25 m)	128 in (3.25 m)
	Hay retention ring (additional height)	0 in / 3.5 in	0 in / 3.5 in
	Width (C)		
	Without incline conveyor	101 in (2.57 m)	101 in (2.57 m)
	With incline conveyor (retracted)	117 in (2.97 m)	117 in (2.97 m)
	Incline conveyor operating angle (degrees)	26 @ 39	26 @ 39
	Outside width of the wheels	100 in (2.54 m)	100 in (2.54 m)
	Lateral distance to discharge point (D) at min.26 angle /max 40		
	Incline conveyor chain / belt 3 ft	30-23in at 26° / 27-20in at 40°	30-28in at 26° / 28-25in at 40°
	Incline conveyor chain / belt 4 ft	39-32in at 26° / 35-28in at 40°	38-36in at 26° / 35-32in at 40°
	Incline conveyor chain / belt 5 ft	53-46in at 26° / 47-40in at 40°	53-51in at 26° / 48-45in at 40°
	Incline conveyor chain / belt 6 ft	62-55in at 26° / 54-47in at 40°	62-60in at 26° / 55-52in at 40°
	Incline conveyor chain / belt 7 ft	76-69in at 26° / 67-60in at 40°	76-74in at 26° / 67-64in at 40°
	Incline conveyor chain / belt 8 ft	85-78in at 26° / 74-67in at 40°	85-83in at 26° / 75-72in at 40°
	Discharge height (E)		
	Incline conveyor chain / belt 3 ft	43-47in at 26° / 53-53in at 40°	41-43in at 26° / 50-50in at 40°
	Incline conveyor chain / belt 4 ft	46-50in at 26° / 59-59in at 40°	45-47in at 26° / 56-56in at 40°
	Incline conveyor chain / belt 5 ft	53-57in at 26° / 69-69in at 40°	52-54in at 26° / 67-67in at 40°
	Incline conveyor chain / belt 6 ft	57-61in at 26° / 76-76in at 40°	56-58in at 26° / 73-73in at 40°
	Incline conveyor chain / belt 7 ft	63-67in at 26° / 86-86in at 40°	60-64in at 26° / 83-83in at 40°
	Incline conveyor chain / belt 8 ft	67-71in at 26° / 92-92in at 40°	63-65in at 26° / 90-90in at 40°
	Floor ST (E1) / Conveyor FD (E2) to ground	44in(1.12m)	34in(0.86m)
	SPECIFICATIONS	PTO shaft - Standard specification	1000 RPM 1" 3/8 Z21
PTO shaft - Option specification		1000 RPM 1"3/4 Z20 540 RPM 1" 3/8 Z6	1000 RPM 1"3/4 Z20 540 RPM 1" 3/8 Z6
2 speed Gear Box		Optional	Optional
2 Speed Gear Box and ratio		C3A-R, 1:1,5 540 RPM C3A-R, 1,8:2,7 1000 RPM	C3A-R, 1:1,5 540 RPM C3A-R, 1,8:2,7 1000 RPM
Minimum PTO HP Requirement - Low Speed		100	100
Minimum PTO HP Requirement - High Speed		150	150
Auger RPM - Low Speed		27 RPM	27 RPM
Auger RPM - Standard High speed		41 RPM	41 RPM
Standard planetary model and ratio configuration		2003 @25.89	2003 @25.89
Optionnal Planetary		2002 @ 13.4 540 RPM	2002 @ 13.4 540 RPM
Floor Thickness (AR235 grade or equivalent)		3/4 in	3/4 in
Sidewall Thickness (AR235 grade or equivalent)		1/4 in	1/4 in
Flighting Thickness (AR235 grade or equivalent)		5/8 in	5/8 in
Standard knives per auger		6 / 10 optional	6 / 10 optional
Driveline security		Shear bolt	Shear bolt
Hydraulic flow requirement		10-15 US gal/ min 37-56 L/ min	10-15 US gal/ min 37-56 L/ min
Hydraulic pressure		160-200 bars (2300-2900 psi)	160-200 bars (2300-2900 psi)
Load cell		4	4
Scale system		DG500 (standard)	DG500 (standard)
Machine Weight (empty) - STD configuration		15 987 lb (7250 kg)	17 117 lb (7763 kg)
Utility load capacity	20 300 lb (9206 kg)	20 300 lb (9206 kg)	
Axle - Standard specifications	Single	Single	
Axle - Option specifications	Tandem	Tandem	
Wheels - Standard specifications	275/70R22.5 (DOUBLE)	275/70R22.5 (DOUBLE)	
Wheels - Option specifications	445/45R19.5	445/45R19.5	

SMARTMIX™ VERTICAL TMR MIXERS

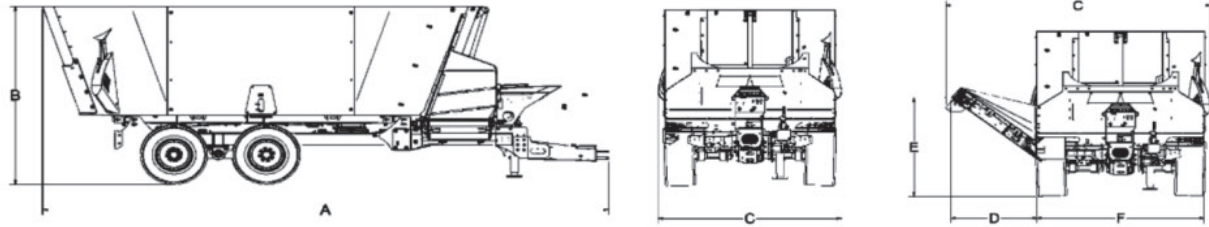

A920ST / HT TWIN AUGER	A920FD TWIN AUGER	A950FD TRIPLE AUGER	A1230FD TRIPLE AUGER
920 ft³ (26.1 m³)	920 ft³ (26.1 m³)	920 ft³ (26.1 m³)	1230 ft³ (34.9 m³)
1004 ft³ (28.5 m³)	1004 ft³ (28.5 m³)	1017 ft³ (28.8 m³)	1344 ft³ (38.1 m³)
1088 ft³ (30.8 m³)	1088 ft³ (30.8 m³)	1114 ft³ (31.6 m³)	1458 ft³ (41.3 m³)
1172 ft³ (33.2 m³)	1172 ft³ (33.2 m³)	1211 ft³ (34.3 m³)	1572 ft³ (44.5 m³)
2	2	3	3
293 in (7.44 m)	314 in (7.98 m)	385 in (9.77 m)	430 in (10.91 m)
122 in (3.1 m)	122 in (3.1 m)	117 in (2.97 m)	117 in (2.97 m)
128 in (3.25 m)	128 in (3.25 m)	123 in (3.12 m)	123 in (3.12 m)
134 in (3.4 m)	134 in (3.4 m)	129 in (3.28 m)	129 in (3.28 m)
140 in (3.56 m)	140 in (3.56 m)	135 in (3.43 m)	135 in (3.43 m)
0 in / 3.5 in	0 in / 3.5 in	0 in / 3.5 in	0 in / 3.5 in

113 in (2.87 m)	113 in (2.87 m)	101 in (2.57 m)	112 in (2.84 m)
126 in (3.2 m)	125 in (3.18 m)	117 in (2.97 m)	124 in (3.15 m)
23 @ 39	26 @ 39	26 @ 39	26 @ 39
100 in (2.54 m)	100 in (2.54 m)	101 in (2.57 m)	101 in (2.57 m)

23-16in at 26° / 20-13in at 40°	23-21in at 26° / 21-18in at 40°	30-28in at 26° / 28-25in at 40°	23-21in at 26° / 21-18in at 40°
32-25in at 26° / 28-21in at 40°	31-29in at 26° / 28-25in at 40°	38-36in at 26° / 35-32in at 40°	31-29in at 26° / 28-25in at 40°
47-40in at 26° / 40-33in at 40°	46-44in at 26° / 41-38in at 40°	53-51in at 26° / 48-45in at 40°	46-44in at 26° / 41-38in at 40°
56-49in at 26° / 47-40in at 40°	55-53in at 26° / 48-45in at 40°	62-60in at 26° / 55-52in at 40°	55-53in at 26° / 48-45in at 40°
71-64in at 26° / 60-53in at 40°	69-67in at 26° / 60-57in at 40°	76-74in at 26° / 67-64in at 40°	69-67in at 26° / 60-57in at 40°
80-73in at 26° / 67-60in at 40°	78-77in at 26° / 68-65in at 40°	85-83in at 26° / 75-72in at 40°	78-76in at 26° / 68-65in at 40°

43-47in at 26° / 53-53in at 40°	41-43in at 26° / 48-48in at 40°	44-46in at 26° / 51-51in at 40°	44-46in at 26° / 51-51in at 40°
46-50in at 26° / 59-59in at 40°	45-47in at 26° / 54-54in at 40°	48-50in at 26° / 57-57in at 40°	48-50in at 26° / 57-57in at 40°
53-57in at 26° / 69-69in at 40°	52-54in at 26° / 65-65in at 40°	55-57in at 26° / 68-68in at 40°	55-57in at 26° / 68-68in at 40°
57-61in at 26° / 76-76in at 40°	56-58in at 26° / 71-71in at 40°	59-61in at 26° / 74-74in at 40°	59-61in at 26° / 74-74in at 40°
63-67in at 26° / 86-86in at 40°	63-65in at 26° / 81-81in at 40°	66-68in at 26° / 84-84in at 40°	66-68in at 26° / 84-84in at 40°
67-71in at 26° / 92-92in at 40°	67-69in at 26° / 88-88in at 40°	70-72in at 26° / 90-90in at 40°	70-72in at 26° / 90-90in at 40°
42in(1.08m)	32in(0.82m)	35in(0.88m)	35in(0.88m)

1000 RPM 1" 3/8 Z21	1000 RPM 1" 3/8 Z21	1000 RPM 1" 3/8 Z21	1000 RPM 1" 3/4 Z20
1000 RPM 1" 3/4 Z20	1000 RPM 1" 3/4 Z20	1000 RPM 1" 3/4 Z20	1000 RPM 1" 3/8 Z21
Option	Option	Standard	Optional
C3A-R, 1:1.5 1000RPM	C3A-R, 1:1.5 1000RPM	A613R, 1.8;2.7 @ 2spd	A613R 2spd, A614R, 1:1.8;3.2@3spd
100	100	120	145
150	150	180	210
22 RPM	22 RPM	27 RPM	18 RPM / 10 RPM
33 RPM	33 RPM	41	33 RPM
2103 @29.9	2103 @29.9	2102 @13.54	3002 @30.24
3002 @ 30.24	3003 @ 30.24	N/A	N/A
3/4 in	3/4 in	3/4 in	3/4 in
1/4 in	1/4 in	1/4 in	1/4 in
5/8 in	5/8 in	5/8 in	5/8 in
8 / 12 optional	8 / 12 optional	6 / 10 optional	8 / 12 optional
Shear bolt	Shear bolt	Shear bolt	Shear clutch
10-15 US gal/min 37-56 L/min	10-15 US gal/min 37-56 L/min	10-15 US gal/ min 37-56 L/ min	10-15 US gal/ min 37-56 L/ min
160-200 bars (2300 - 2900 psi)	160-200 bars (2300 - 2900 psi)	160-200 bars (2300-2900 psi)	160-200 bars (2300-2900 psi)
4	4	6	6
D6500 (standard)	D6500 (standard)	D6500 (standard)	D6500 (standard)
16 987 lb (7721kg)	18 117 lb (8235kg)	23 460 lb (10639 kg)	28 991 lb (13148 kg)
26 680 lb (12100kg)	26 680 lb (12100kg)	26 680 lb (12100 kg)	35 670 lb (16177 kg)
Tandem	Tandem	Tandem	Tandem
N/A	N/A	N/A	Tridem / self steering axle
445/45R19.5	445/45R19.5	445/45R19.5	275/70R22.5 (DOUBLE)
N/A	N/A	N/A	445/45R19.5

FIND THE RIGHT PRODUCT
FOR YOU WITH ANDERSON!





ANDERSON

FIELD THE BEST



VERTICAL STATIONARY TMR MIXERS



VERTICAL STATIONARY TMR MIXERS

ANDERSON

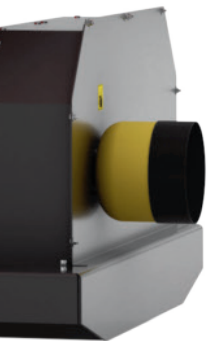

HOW TO CHOOSE YOUR MIXER SIZE

When sizing an TMR mixer, it is best to base the calculation on the volume in cubic feet (ft³) and not in pounds (lb). It's safe to say that a normal dairy cow consumes 5 to 7 ft³ of a ration of TMR per day.

Determine the ration consumed per animal

5 ft³

Ration consisting of ingredients such as cut silage (corn silage, etc., does not include long stem hay).

6 ft³

Ration consisting of ingredients such as cut silage and long-stemmed hay. Ideal for digestion and rumen health of the cow.

7 ft³

Ration consisting of large amounts of long-stemmed hay, such as silage bales and dry hay.

Calculate the total quantity consumed and identify the mixer that responds to your needs

- 1) Take the maximum number of animals in your larger group to feed, multiply by the number of ft³ consumed per animal, set earlier between 5, 6 or 7 cu.
- 2) Divide it by the number of times a day where you plan to mix and feed. The results will give you the total number of ft³ to be processed by the mixer for each ration to be mixed.
- 3) This figure determines the optimum capacity of the mixer to use according to your current situation.

Be aware that the quality of the mix obtained is optimal when the mixer is filled between 40 % and 90 % of its total capacity.

Example

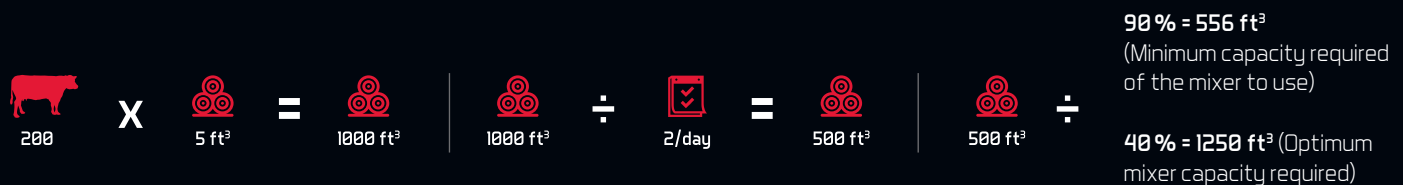

$200 \times 5 \text{ ft}^3 = 1000 \text{ ft}^3$

$1000 \text{ ft}^3 \div 2/\text{day} = 500 \text{ ft}^3$

$90\% = 556 \text{ ft}^3$ (Minimum capacity required of the mixer to use)

$40\% = 1250 \text{ ft}^3$ (Optimum mixer capacity required)

Remember, if you have plans to expand your herd, take it into consideration for choosing the right mixer model!

UNIQUE DESIGN

The choice of mixer is crucial to the success of your business. The unique design of the augers and the tank have been designed to obtain optimal mix. Whether you incorporate round or square bales, silage or supplements into your ration, Anderson mixers will help you reach your nutrition goals.

They will save you time and money with each use. Day after day, the robustness and efficiency of the Anderson Smartmix mixer will surprise you.



SMARTMIX™ vertical mixers

- Process and mix large amounts of hay, round bales, square bales and silage bales.
- Produces a homogeneous blend of optimal quality every time
- Available with several unloading options for uniform unloading
- Uses a simple drive system
- Hydraulically controlled restriction blades (fastest bale processing mixer on the market)
- Electrical motorization
- Silent belt conveyors operating at very high speed (faster unloading)



ANDERSON
FIELD THE BEST

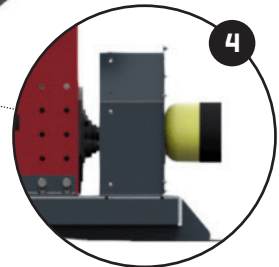
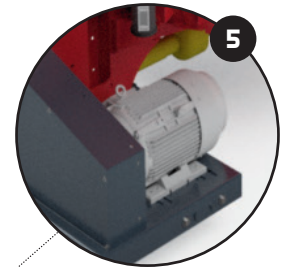
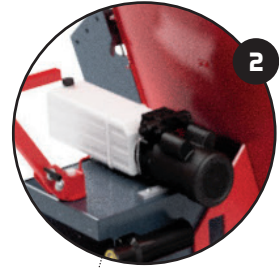
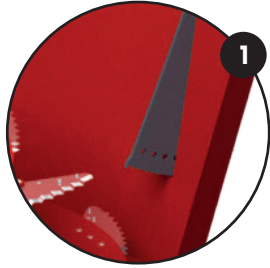

WHAT SETS US APART

1) TRUE-CUT™: Restriction blade system

We find on all our mixer models, two restriction blades arranged 180 ° from each other. When fully engaged, they can be inserted up to 8" into the tank to slow the movement of the material. Coming standard with a multitude of mechanical adjustments, Anderson is the only manufacturer to offer you a system to activate them hydraulically (optional). Connected to the feed panel, you will be able to insert the plates when processing long fibers and remove them when inserting the silages. This will reduce the chopping time while preserving the integrity of the other ingredients. With complete and perfect control, you will be able to produce an always optimal blend.

2) Hydraulic unit

Our hydraulic unit allows us to operate the trap as well as the folding of the inclined conveyor. For an optimal yield and whatever the season, we use an oil which is able to fight our worst climatic situations.

3) Incline conveyor up to 8 ft

On all our stationary mixers, it is possible to install an inclined conveyor (chain or belt available). Located on either side of the tank and up to 8' length, we will be able to meet your unloading requirements. Foldable hydraulically, you will be able to free it from the passage when it is not in use.

4) Emergency PTO adapter

All of our stationary mixers come standard with an adapter that allows you to connect a tractor in the event of a power outage. Even at critical moments, you will be able to feed your herd.

5) Power unit

In order to free up space in front of the mixers and to facilitate access to the electric motor, we can install its tray on the right or left front side. The electric power of the motor required for each mixer was calculated and determined according to the capacity of the tank, the load and the type of forage to be produced.

6) Unloading trap

The movement of the unloading trap must be quick and powerful. The use of a hydraulic cylinder remains the simplest and most effective solution. Combined with our hydraulic protection system for opening and closing, this system guarantees very high reliability.

Benefits of a rolled tub SMARTMIX™

We designed our tubs with rolled walls (not bent) giving them the following advantages:

- The walls of our SMARTMIX™ tank are rolled at their ends. With this folding-free manufacturing process, we get completely smooth sides that allow to minimize friction and improve the circulation of material in the tank.
- With each ration, you will quickly obtain a homogeneous mix regardless of the quantity to be mixed.
- In addition to increasing the yield of your herd, you will save energy when preparing your mix.
- The monobloc tank floor without joints is reinforced to absorb load constraints.
- The Smartmix tank wall joints overlap and are then bolted and welded for rock solid strength.

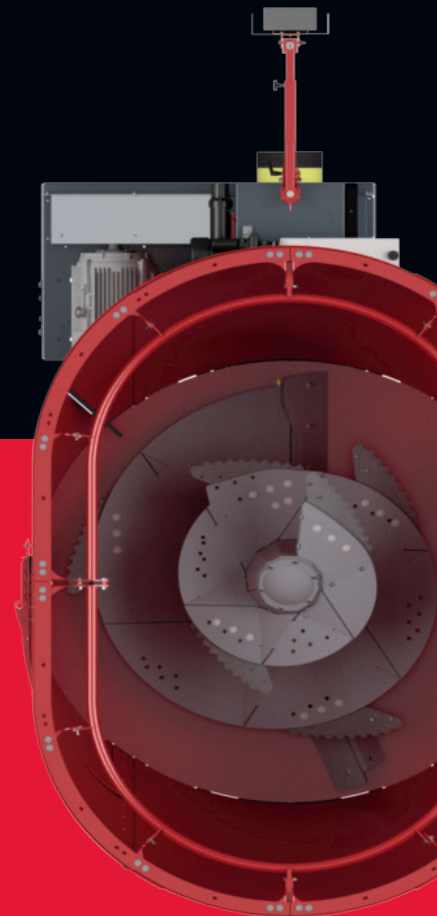



Before purchasing any equipment, carefully read the technical specifications section of the product in question. Some features and options may not be available for all models.

Capacity extensions

Adding steel capacity extensions will get you to the desired level of production, unlike rubber extensions that break and crack, and cause replacement costs year after year.

- Height of 6 in, 12 in and 18 in.
- Possibility of adding a retention ring, this option can be bolted directly to the metal extension or to the tank itself. This addition to your mixer will allow you to avoid overflowing the material as well as reduce the time to process your round bales.

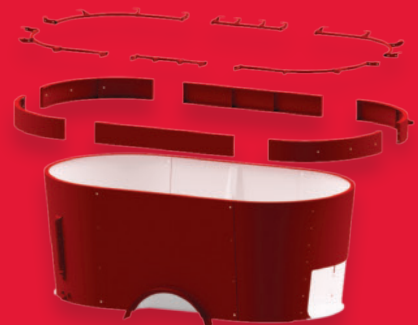

STRENGTH AND LONGEVITY

THE BEST OF BOTH WORLDS

1) Auger extension : exclusive to Anderson

With a height of 14 in and equipped with two additional knives, this boltable extension can be installed on the majority of our mixers (usually used with an 18 in extension). This exclusive Anderson option allows you to keep the same height relationship between the auger and the walls when adding tub extension. Even if you add more volume to the inside of the tub, the material on the top will still be mixed thanks to the horizontal and vertical movement caused by the auger extension. This option also allows you to advance the capacity of your mixer while tracking the evolution of your herd.

2) Magnet on the auger

The neodymium magnet can be optionally installed on the back of the scraper of our augers. Being always in contact with the material during the mixing process and during unloading, this magnet provides excellent efficiency at all times.

3) Tungsten carbide knives

The tungsten carbide knives last three times longer than the competition. With a Rockwell hardness of 45, they sharpen automatically and ensure a perfect cutting quality day after day. Installed in standard on each auger, they are adjustable in two positions and reversible, thus doubling their lifespan. Thanks to their oversized and very aggressive serrated blades, they offer exceptional performance for round or square bales. Each knife is equipped with a reinforcement plate to absorb the impacts of round bales when thrown into the tub.

4) Sweepers

Often optional on competition models, our sweepers are installed and welded on the base of our augers as a standard. The sweepers provide additional material movement during mixing and unloading 30% faster and more uniformly than machines without this equipment.

5) Inspection and maintenance hatch

Each of the auger is provided with an inspection hatch to clean the inside of the auger in order to check if the planetaries have sufficient lubrication. It also allows better access for mechanical interventions.

6) High resistance steel

All Anderson mixers are made from Hardox (AR235) steel plates. This very high abrasion resistance steel is widely used in the industrial and mining fields. Stronger and more durable, this steel will provide unmatched longevity to your mixer.

Our reinforced floor, our welded cross tank walls will be able to absorb the worst load constraints. You are looking for a machine that will last over time, the Anderson mixers were made for you and will be able to meet your expectations.

Planetaries

Each planetary was carefully chosen based on uniqueness of each model and the most extreme working conditions on the market.

In the component selection process, Anderson has worked closely with Comer's engineers to ensure product excellence, and to provide you with peace of mind and an excellent warranty.



THE ADVANTAGES OF THE TRI-CUT™ AUGER

- Spiral-shaped augers lift the material vertically, creating the “up and down” effect. The rotation of the auger also provides a “forward / backward” effect to the cycle.
- The upward movement of the feed combined with the downward movement along the tub wall provides perfect mixing.
- The unique triangular position of the Anderson knives around the auger allows you to quickly process all types of bales, even frozen, and speed up the flow of material.
- Anderson offers an AR235 high strength steel augers.
- The cutting blades are reinforced to avoid breaking in cold conditions or when processing frozen bales.
- The small distance between the interior walls and the screw has the advantage of creating a very large displacement of the ingredients in the tank. The upward movement of the feed to the combined medium downward movement along the wall of the tub provides a total ration with a perfectly homogeneous mix.

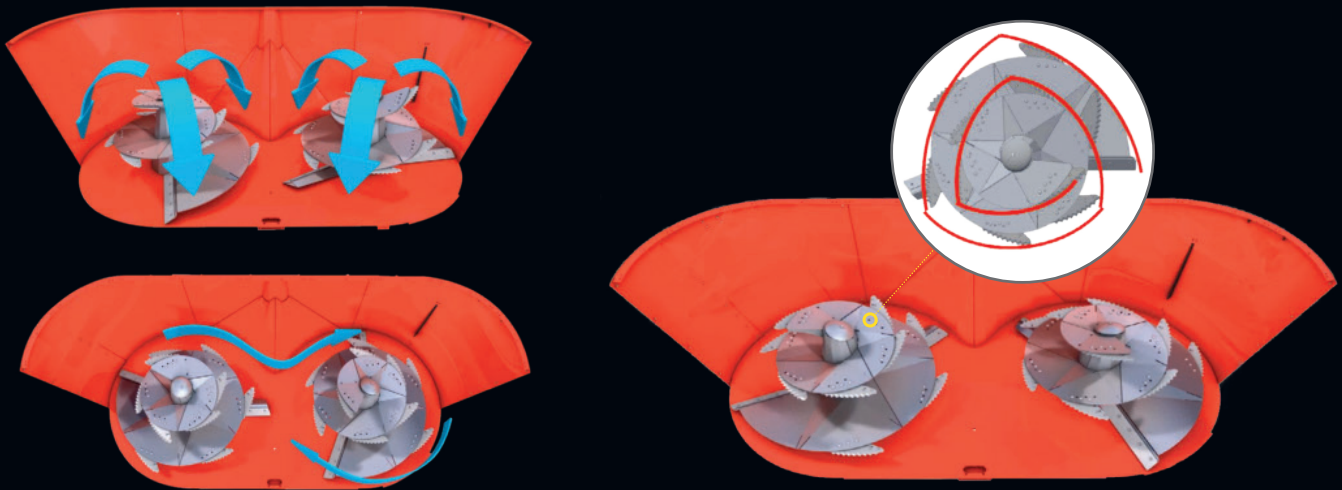

Knives, the part that must not be overlooked.

The wear and tear of knives over the life of a machine is an expense that should not be overlooked. Here are some advantages of Anderson knives:

- Price 30 to 50 % cheaper than the competition!
- Tungsten carbide three times more durable
- Automatic sharpening and perfect cutting quality
- Reversible, they have a double lifespan
- Aggressive oversized serrated blade
- Installed on reinforcement plate to absorb bale impacts



MORE FUNCTIONAL COMPUTER

OFFERED BY SMARTMIX™

DG500 weight indicator computer

Le DG500 weight indicator (optional) is compatible with the DTM suite, the DG500 computer is a universal weighing indicator. It allows the programming of recipes and distribution as well as the storage of data. It guarantees extremely precise weighing thanks to the protected load cells, distributed strategically under the tank.

The interface is composed of a dual LCD that makes it clear. The software allows you to program 24 recipes that can contain 48 components and 48 different distribution points, to configure the component names, the distribution points and the program in your own language and to classify the programs by "quantity", "total" or "number of animals". The "total" or "number of animals" loading can be placed before the run, in order to have a program that is always in accordance with the needs of the animal.

Mobile application

The dina TEL 3 app is the ultimate technology that brings weight indicator control to your smartphone or tablet. By installing the app, you can turn your phone into a weight indicator and make the charging process more efficient.



Weight display repeater screen

The weight repeater makes it possible to have a second display directed towards the operator who loads the ingredients into the mixer.





S280

Single auger stationary vertical TMR mixer



Capacity 280 ft³ (7.9 m³)
to 388 ft³ (11 m³)



Height 97 in (2.46 m)
to 115 in (2.92 m) with extension



Power unit 30 HP



Unloading material by side trap



1 augers with 6 reversible knives
each in carbide tungsten
(10 knives per auger, optional)



S380

Single auger stationary vertical TMR mixer



Capacity 380 ft³ (10,8 m³)
to 500 ft³ (14,2 m³)



Height 100 in (2,54 m)
to 118 in (3 m) with extension



Power unit 40 HP



Unloading material by side trap



1 augers with 6 reversible knives
each in carbide tungsten
(10 knives per auger, optional)



5450

Single auger stationary vertical TMR mixer



Capacity 450 ft³ (12,8 m³)
to 600 ft³ (17 m³)



Height 106 in (2,69 m³)
to 124 in (3,15 m³) with extension



Power unit 50 HP



Unloading material by side trap



1 augers with 8 reversible knives
each in carbide tungsten
(12 knives per auger, optional)



S520

Twin auger stationary vertical TMR mixer



Capacity 520 ft³ (14,7 m³)
to 682 ft³ (19,3 m³)



Height 98 in (2,5 m)
to 116 in (2,95 m) with extension



Power unit 60 HP



Unloading material by side trap



2 augers with 6 reversible knives
each in carbide tungsten
(10 knives per auger, optional)



5700

Single auger stationary vertical TMR mixer



Capacity 700 ft³ (19,8 m³)
to 910 ft³ (25,8 m³)



Height 104 in (2,64 m)**
à 124 in (3,15 m)** with extension



Power unit 100 HP



Unloading material by side trap



1 augers with 6 reversible knives
each in carbide tungsten
(10 knives per auger, optional)



5920

Twin auger stationary vertical TMR mixer



Capacity 920 ft³ (26,1 m³)
to 1172 ft³ (33,2 m³)



Height 116 in (2,95 m)**
to 134 in (3,40 m)* with extension



Power unit 125 HP



Unloading material by side trap



2 augers with 8 reversible knives
each in carbide tungsten
(12 knives per auger, optional)

TECHNICAL SPECIFICATIONS

	5280ST	5380ST	5450ST / HT	
CAPACITY	Capacity (no capacity extension)	280 ft ³ (7.9 m ³)	380 ft ³ (10.8 m ³)	450 ft ³ (12.8 m ³)
	6 in capacity extension	316 ft ³ (9 m ³)	420 ft ³ (11.9 m ³)	500 ft ³ (14.2 m ³)
	12 in capacity extension	352 ft ³ (10 m ³)	460 ft ³ (13 m ³)	550 ft ³ (15.6 m ³)
	18 in capacity extension	388 ft ³ (11 m ³)	500 ft ³ (14.2 m ³)	600 ft ³ (17 m ³)
	Number of Auger	1	1	1
DIMENSIONS	Length (A)	140 in (3.56 m)	154 in (3.91 m)	154 in (3.92 m)
	Height (B) no extension	97 in (2.46 m)	100 in (2.54 m)	106 in (2.69 m)
	6 in capacity extension	103 in (2.62 m)	106 in (2.69 m)	112 in (2.84 m)
	12 in capacity extension	109 in (2.77 m)	112 in (2.84 m)	118 in (3 m)
	18 in capacity extension	115 in (2.92 m)	118 in (3 m)	124 in (3.15 m)
	Hay retention ring (additional height)	0 in / 3.5 in	0 in / 3.5 in	0 in / 3.5 in
	Width (C)			
	Without incline conveyor	90 in (2.29 m)	101 in (2.57 m)	112 in (2.84 m)
	With incline conveyor (retracted)	106 in (2.69 m)	117 in (2.97 m)	125 in (3.18 m)
	Incline conveyor operating angle (degrees)	26 @ 39	26 @ 39	23 @ 39
	Lateral distance to discharge point (D)			
	Incline conveyor 3ft Chain-Belt 26°	36 in(91cm) -29in(74cm)	30in(72cm) -23in(58cm)	23in(58cm) -16in(41cm)
	Incline conveyor 4ft Chain-Belt 26°	45in(114cm) -38in(96cm)	39in(99cm) -32in(81cm)	32in(81cm) -25in(64cm)
	Incline conveyor 5ft Chain-Belt 26°	59in(150cm) -52in(132cm)	53in(137cm) -46in(117cm)	47in(119cm) -40in(102cm)
	Incline conveyor 6ft Chain-Belt 26°	68in(172cm) -61in(156cm)	62in(157cm) -55in(140cm)	56in(142cm) -49in(124cm)
	Incline conveyor 7ft Chain-Belt 26°	82in(208cm) -75in(190cm)	76in(201cm) -69in(175cm)	71in(180cm) -64in(163cm)
	Incline conveyor 8ft Chain-Belt 26°	91in(231cm) -84in(213cm)	85in(216cm) -78in(198cm)	80in(203cm) -73in(185cm)
	Incline conveyor 3ft Chain-Belt 40°	33in(84cm) -26in(66cm)	27in(69cm) -20in(51cm)	20in(51cm) -13in(33cm)
	Incline conveyor 4ft Chain-Belt 40°	40in(102cm) -33in(84cm)	35in(89cm) -28in(71cm)	28in(71cm) -21in(53cm)
	Incline conveyor 5ft Chain-Belt 40°	53in(135cm) -46in(117cm)	47in(119cm) -40in(101cm)	40in(102cm) -33in(84cm)
	Incline conveyor 6ft Chain-Belt 40°	60in(152cm) -53in(135cm)	55in(140cm) -48in(122cm)	47in(119cm) -40in(102cm)
	Incline conveyor 7ft Chain-Belt 40°	73in(185) -66in(167cm)	67in(170cm) -60in(152cm)	60in(152cm) -53in(135cm)
	Incline conveyor 8ft Chain-Belt 40°	80in(203) -73in(185cm)	74in(188cm) -67in(170cm)	67in(170cm) -60in(152cm)
	Discharge height (E3)			
	Incline conveyor 3ft Chain-Belt 26°	30in(76cm)-34in(86cm)	30in(76cm)-34in(86cm)	29in(74cm) -33in(83cm)
	Incline conveyor 4ft Chain-Belt 26°	34in(86cm) -38in(97cm)	34in(86cm) -38in(97cm)	33in(83cm) -37in(94cm)
	Incline conveyor 5ft Chain-Belt 26°	41in(104cm) -45in(114cm)	41in(104cm) -45in(114cm)	39in(99cm) -43in(109cm)
	Incline conveyor 6ft Chain-Belt 26°	45in(114cm) -49in(124cm)	46in(117cm) -50in(127cm)	43in(109cm) -47in(119cm)
	Incline conveyor 7ft Chain-Belt 26°	52in(132cm) -56in(142cm)	53in(135cm) -57in(145cm)	49in(124cm) -53in(135cm)
	Incline conveyor 8ft Chain-Belt 26°	57in(145cm) -61in(155cm)	57in(145cm) -61in(155cm)	53in(135cm) -57in(145cm)
	Incline conveyor 3ft Chain-Belt 40°	40in(102cm) -40in(102cm)	40in(102cm) -40in(102cm)	40in(102cm) -40in(102cm)
	Incline conveyor 4ft Chain-Belt 40°	46in(117cm) -46in(117cm)	46in(117cm) -46in(117cm)	47in(119cm) -47in(119cm)
	Incline conveyor 5ft Chain-Belt 40°	56in(142cm)-56in(142cm)	57in(145cm) -57in(145cm)	57in(145cm) -57in(145cm)
Incline conveyor 6ft Chain-Belt 40°	63in(160cm) -63in(160cm)	63in(160cm) -63in(160cm)	63in(160cm) -63in(160cm)	
Incline conveyor 7ft Chain-Belt 40°	73in(185cm) -73in(185cm)	73in(185cm) -73in(185cm)	73in(185cm) -73in(185cm)	
Incline conveyor 8ft Chain-Belt 40°	79in(210cm) -79in(201cm)	79in(210cm) -79in(201cm)	79in(201cm) -79in(201cm)	
Floor ST (E1) / Conveyor FD (E2) to ground	29in(0.72m)	29in(0.74m)	33in(0.84m)	
SPECIFICATIONS	PTO shaft - Standard specification	540 RPM 1" 3/8 Z6	540 RPM 1" 3/8 Z6	540 RPM 1" 3/8 Z6
	Minimum PTO HP Requirement - High Speed	30	40	50
	Auger RPM - Standard High speed	20 RPM	20 RPM	20 RPM
	Standard planetary model and ratio configuration	1603 @25.89	1603 @25.89	1603 @25.89
	Floor Thickness (AR235 grade or equivalent)	5/8 in	3/4 in	3/4 in
	Sidewall Thickness (AR235 grade or equivalent)	1/4 in	1/4 in	1/4 in
	Flighting Thickness (AR235 grade or equivalent)	5/8 in	5/8 in	5/8 in
	Standard knives per auger	6 / 10 optional	6 / 10 optional	8 / 12 optional
	Driveline security	Shear bolt	Shear bolt	Shear bolt
	Load cell	3	3	N/A
	Scale system	Option D6500	Option D6500	Option D6500
	Machine Weight (empty) - STD configuration	7548 lb (3423 kg)	8890 lb (4032 kg)	9251 lb (4195 kg)
Utility load capacity	8120 lb (3683 kg)	11 020 lb (4998 kg)	13 050 lb (5918 kg)	

* The dimensions given are the center of the conveyor pulley on the ground

* You must subtract at least 10 " from its values to know the height of the obstacle to feeding. In case of doubt, please contact the technical service.

S520ST	S700ST	S700FD	S920ST / HT	S920FD
520 ft³ (14.7 m³)	700 ft³ (19.8 m³)	700 ft³ (19.8 m³)	920 ft³ (26.1 m³)	920 ft³ (26.1 m³)
574 ft³ (16.3 m³)	770 ft³ (21.8 m³)	770 ft³ (21.8 m³)	1004 ft³ (28.5 m³)	1004 ft³ (28.5 m³)
628 ft³ (17.8 m³)	840 ft³ (23.8 m³)	840 ft³ (23.8 m³)	1088 ft³ (30.8 m³)	1088 ft³ (30.8 m³)
682 ft³ (19.3 m³)	910 ft³ (25.8 m³)	910 ft³ (25.8 m³)	1172 ft³ (33.2 m³)	1172 ft³ (33.2 m³)
2	2	2	2	2
208 in (5.27 m)	267 in (6.78 m)*	267 in (6.78 m)*	272 in (6.91 m)*	272 in (6.91 m)*
98 in (2.5 m)	104 in (2.64 m)**	104 in (2.64 m)**	116 in (2.95 m)**	116 in (2.95 m)**
104 in (2.65 m)	110 in (2.80 m)**	110 in (2.80 m)**	122 in (3.10 m)**	122 in (3.10 m)**
110 in (2.8 m)	116 in (2.95 m)**	116 in (2.95 m)**	128 in (3.25 m)**	128 in (3.25 m)**
116 in (2.95 m)	124 in (3.15 m)**	124 in (3.15 m)**	134 in (3.40 m)**	134 in (3.40 m)**
0 in / 3.5 in	0 in / 3.5 in	0 in / 3.5 in	0 in / 3.5 in	0 in / 3.5 in

101 in (2.57 m)	107 in (2.72 m)	107 in (2.72 m)	113 in (2.87 m)	113 in (2.87 m)
115 in (2.92 m)	123 in (3.12 m)	123 in (3.12 m)	126 in (3.2 m)	126 in (3.2 m)
23 @ 39	26 @ 39	26 @ 39	23 @ 39	23 @ 39

29in(74cm) -22in(56cm)	30in(76cm) -23in(58cm)	30in(76cm) -23in(58cm)	23in(58cm) -16in(41cm)	23in(58cm) -16in(41cm)
38in(97cm) -31in(79cm)	39in(99cm) -32in(81cm)	39in(99cm) -32in(81cm)	32in(81cm) -25in(64cm)	32in(81cm) -25in(64cm)
53in(135cm) -46in(117cm)	53in(135cm) -46in(117cm)	53in(135cm) -46in(117cm)	47in(119cm) -40in(102cm)	47in(119cm) -40in(102cm)
62in(158cm) -55in(140cm)	62in(157cm) -55in(140cm)	62in(157cm) -55in(140cm)	56in(142cm) -49in(124cm)	56in(142cm) -49in(124cm)
77in(196cm) -70in(178cm)	76in(193cm) -69in(175cm)	76in(193cm) -69in(175cm)	71in(180cm) -64in(163cm)	71in(180cm) -64in(163cm)
86in(218cm) -79in(201cm)	85in(216cm) -78in(198cm)	85in(216cm) -78in(198cm)	80in(203cm) -73in(185cm)	80in(203cm) -73in(185cm)
27in(69cm) -20in(51cm)	27in(69cm) -20in(51cm)	27in(69cm) -20in(51cm)	20in(51cm) -13in(33cm)	20in(51cm) -13in(33cm)
35in(89cm) -28in(71cm)	35in(89cm) -28in(71cm)	35in(89cm) -28in(71cm)	28in(71cm) -21in(53cm)	28in(71cm) -21in(53cm)
47in(119cm) -40in(102cm)	47in(119cm) -40in(102cm)	47in(119cm) -40in(102cm)	40in(102cm) -33in(84cm)	40in(102cm) -33in(84cm)
55in(140cm) -48in(122cm)	54in(137cm) -47in(119cm)	54in(137cm) -47in(119cm)	47in(119cm) -40in(102cm)	47in(119cm) -40in(102cm)
67in(170cm) -60in(152cm)	67in(170cm) -60in(152cm)	67in(170cm) -60in(152cm)	60in(152cm) -53in(135cm)	60in(152cm) -53in(135cm)
75in(191cm) -68in(173cm)	74in(188cm) -67in(170cm)	74in(188cm) -67in(170cm)	67in(170cm) -60in(152cm)	67in(170cm) -60in(152cm)

29in(74cm) -33in(83cm)	40in(102cm) -44in(112cm) **	40in(102cm) -44in(112cm) **	40in(102cm) -44in(112cm) **	40in(102cm) -44in(112cm) **
33in(83cm) -37in(94cm)	43in(109cm) -47in(119cm) **	43in(109cm) -47in(119cm) **	43in(109cm) -47in(119cm) **	43in(109cm) -47in(119cm) **
39in(99cm) -43in(109cm)	50in(127cm) -54in(137cm) **	50in(127cm) -54in(137cm) **	50in(127cm) -54in(137cm) **	50in(127cm) -54in(137cm) **
43in(109cm) -47in(119cm)	54in(137cm) -58in(142cm) **	54in(137cm) -58in(142cm) **	54in(137cm) -58in(142cm) **	54in(137cm) -58in(142cm) **
49in(124cm) -53in(135cm)	60in(152cm) -64in(163cm) **	60in(152cm) -64in(163cm) **	60in(152cm) -64in(163cm) **	60in(152cm) -64in(163cm) **
53in(135cm) -57in(145cm)	64in(163cm) -68in(172cm) **	64in(163cm) -68in(172cm) **	64in(163cm) -68in(172cm) **	64in(163cm) -68in(172cm) **
39in(99cm) -39in(99cm)	48in(122cm) -48in(122cm) **	48in(122cm) -48in(122cm) **	48in(122cm) -48in(122cm) **	48in(122cm) -48in(122cm) **
46in(117cm) -46in(117cm)	54in(137cm) -54in(137cm) **	54in(137cm) -54in(137cm) **	54in(137cm) -54in(137cm) **	54in(137cm) -54in(137cm) **
56in(142cm) -56in(142cm)	64in(163cm) -64in(163cm) **	64in(163cm) -64in(163cm) **	64in(163cm) -64in(163cm) **	64in(163cm) -64in(163cm) **
62in(157cm) -62in(157cm)	71in(180cm) -71in(180cm) **	71in(180cm) -71in(180cm) **	71in(180cm) -71in(180cm) **	71in(180cm) -71in(180cm) **
72in(183cm) -72in(183cm)	81in(206cm) -81in(206cm) **	81in(206cm) -81in(206cm) **	81in(206cm) -81in(206cm) **	81in(206cm) -81in(206cm) **
79in(201cm) -79in(201cm)	87in(221cm) -87in(221cm) **	87in(221cm) -87in(221cm) **	87in(221cm) -87in(221cm) **	87in(221cm) -87in(221cm) **
33in(0.84m)	37in(0.94m)**	37in(0.94m)**	37in(0.94m)**	37in(0.94m)**

540 RPM 1" 3/8 Z6	540 RPM 1" 3/4 Z20	540 RPM 1" 3/4 Z20	540 RPM 1" 3/4 Z20	540 RPM 1" 3/4 Z20
60	100	100	125	125
20 RPM	17 RPM	17 RPM	17 RPM	17 RPM
1603 @25.89	1603 @25.89	1603 @25.89	2103 @29.9	2103 @29.9
5/8 in	3/4 in	3/4 in	3/4 in	3/4 in
1/4 in	1/4 in	1/4 in	1/4 in	1/4 in
5/8 in	5/8 in	5/8 in	5/8 in	5/8 in
6 / 10 optional	6 / 10 optional	6 / 10 optional	8 / 12 optional	8 / 12 optional
Shear bolt	Shear bolt	Shear bolt	Shear bolt	Shear bolt
3	4	4	4	4
Option D6500	Option D6500	Option D6500	Option D6500	Option D6500
12 431 lb (5638 kg)	14586 lb (6630 kg)	14586 lb (6630 kg)	15374 lb (6988 kg)	15374 lb (6988 kg)
15 080 lb (6839 kg)	20300 lb (9206 kg)	20300 lb (9206 kg)	26680 lb (12100 kg)	26680 lb (12100 kg)

DOWNLOAD THE Anderson APP

To find everything in one place:

Start-up documents

Find a dealer

Pictures

Videos

Product catalog

Technical support by
chat available 24/7





ANDERSON GROUP
5125, rue de la Plaisance
Chester ville (Québec)
G0P 1J0, Canada

T : 1 888 833-2952
F : 1 819 382-2643

www.grpanderson.com

GENERAL

Office : 1 888 833-2952
Email : info@grpanderson.com
Website : www.grpanderson.com

SALES

Office : 1 888 833-2952
Email : usa@grpanderson.com

PARTS AND SERVICE

Office : 1 888 833-2952
Fax : 1 819 382-2643
Email : support@grpanderson.com

MARKETING

Office : 1 888 833-2952
Email : marketing@grpanderson.com

 **YouTube** [GROUPANDERSON](https://www.youtube.com/GroupAnderson)

 **ANDERSON GROUP**

All illustrations, photographs and specifications within this catalog are based on the latest product information and may be changed at any time without prior notification or obligation. Anderson Group makes no representation as to the accuracy of this information and reserves the right to make changes at any time, without notice.

**DISCOVER OUR
LINE OF FORESTRY
PRODUCTS**

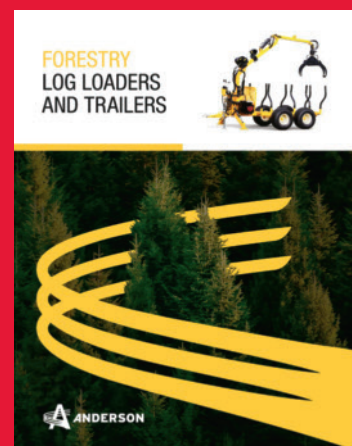

GRPANDERSON.COM

